

SANYO	No.3872	2SA1824/2SC4728
PNP/NPN Epitaxial Planar Silicon Transistors		
50V/5A Switching Applications		

Applications

- Relay drivers, high-speed inverters, converters, and other general high-current switching applications.

Features

- Low collector-to-emitter saturation voltage.
- High Gain-Bandwidth Product.
- Excellent linearity of DC Current Gain.
- Fast switching speed.

() : 2SA1824

Absolute Maximum Ratings at Ta = 25°C

			unit
Collector-to-Base Voltage	V _{CB0}	(-) 60	V
Collector-to-Emitter Voltage	V _{CE0}	(-) 50	V
Emitter-to-Base Voltage	V _{EB0}	(-) 6	V
Collector Current	I _C	(-) 5	A
Collector Current (Pulse)	I _{CP}	(-) 8	A
Base Current	I _B	(-) 1	A
Collector Dissipation	P _C	1.5	W
Junction Temperature	T _J	150	°C
Storage Temperature	T _{stg}	-55 to +150	°C

Electrical Characteristics at Ta = 25°C

			min	typ	max	unit
Collector Cutoff Current	I _{CB0}	V _{CB} = (-)40V, I _E = 0			(-) 1	μA
Emitter Cutoff Current	I _{EB0}	V _{EB} = (-)4V, I _C = 0			(-) 1	μA
DC Current Gain	h _{FE} (1)	V _{CE} = (-)2V, I _C = (-)500mA	100*		400*	
	h _{FE} (2)	V _{CE} = (-)2V, I _C = (-)4A		35		
Gain-Bandwidth Product	f _T	V _{CE} = (-)5V, I _C = (-)1A		(130)180		MHz
Output Capacitance	C _{ob}	V _{CB} = (-)10V, f = 1MHz		(60)40		pF

Continued on next page.

* : The 2SA1824/2SC4728 are classified by 500mA h_{FE} as follows

100	R	200	140	S	280	200	T	400
-----	---	-----	-----	---	-----	-----	---	-----

Package Dimensions 2084B

(unit: mm)

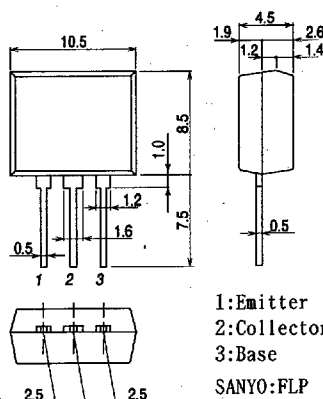

Continued from preceding page.

			min	typ	max	unit
C-E Saturation Voltage	$V_{CE(sat)}$	$I_C = (-)3A, I_B = (-)0.15A$		(-280)	(-550)	mV
B-E Saturation Voltage	$V_{BE(sat)}$	$I_C = (-)3A, I_B = (-)0.15A$		220	400	mV
C-B Breakdown Voltage	$V_{(BR)CBO}$	$I_C = (-)10\mu A, I_E = 0$	(-60)			V
C-E Breakdown Voltage	$V_{(BR)CEO}$	$I_C = (-)1mA, R_{BE} = \infty$	(-50)			V
E-B Breakdown Voltage	$V_{(BR)EBO}$	$I_E = (-)10\mu A, I_C = 0$	(-6)			V
Turn-on Time	t_{on}	See specified Test Circuit.		50		ns
Storage Time	t_{stg}	"		(450)500		ns
Fall Time	t_f	"		20		ns

Switching Time Test Circuit

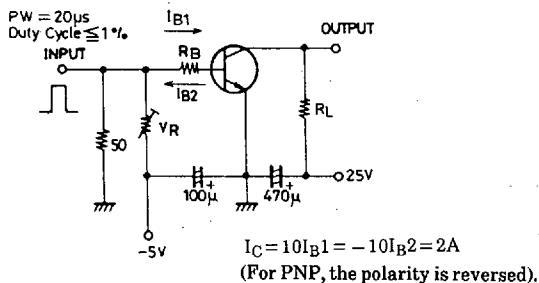

Unit (resistance : Ω, capacitance : F)

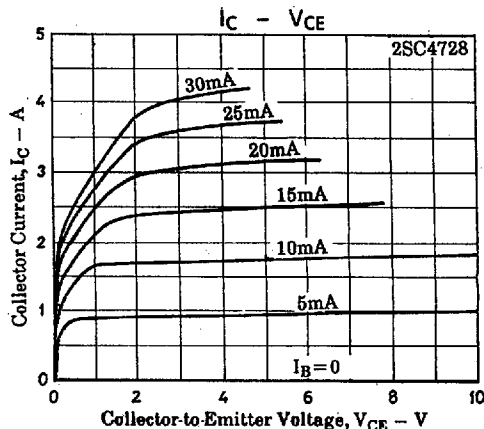
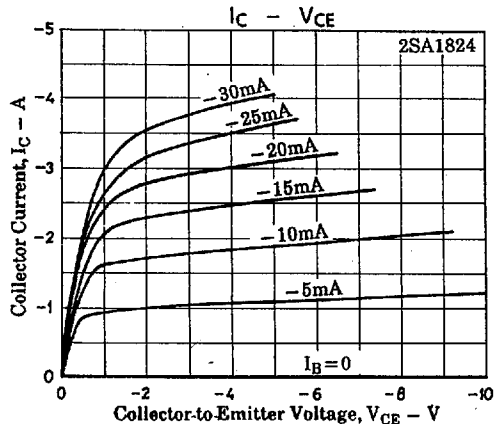
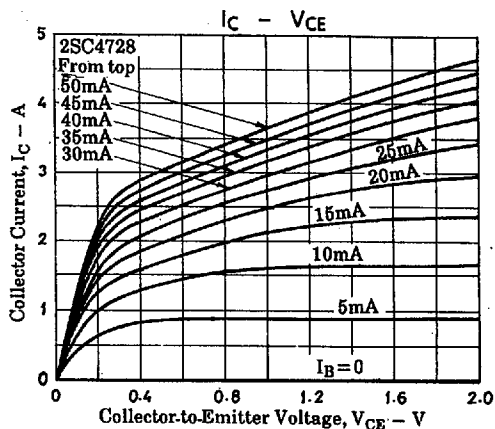
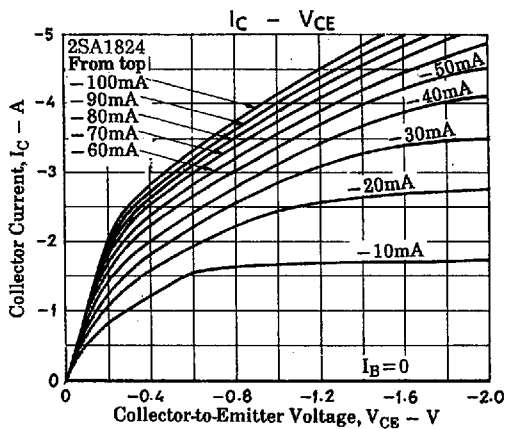

2SA1824/2SC4728

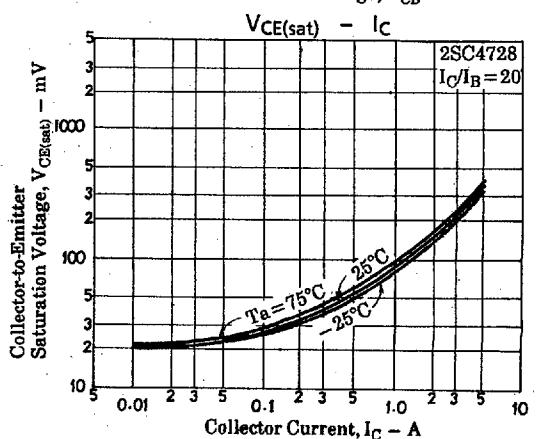
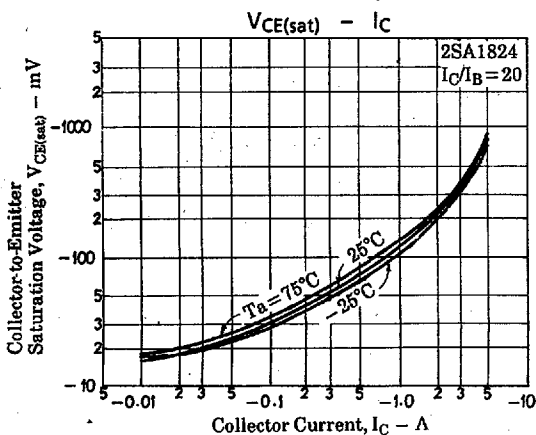
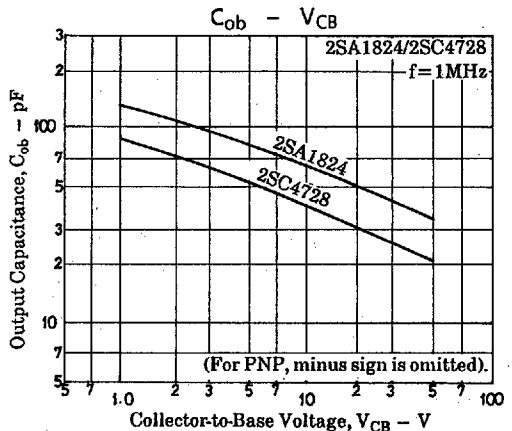
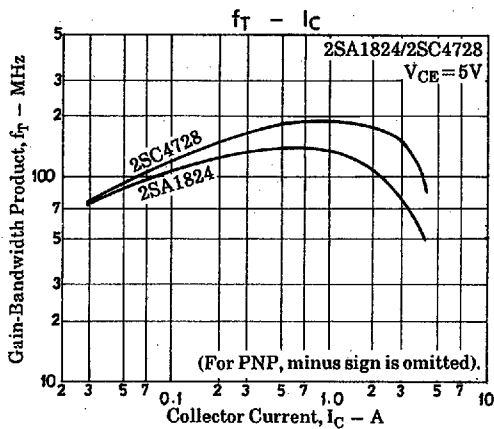
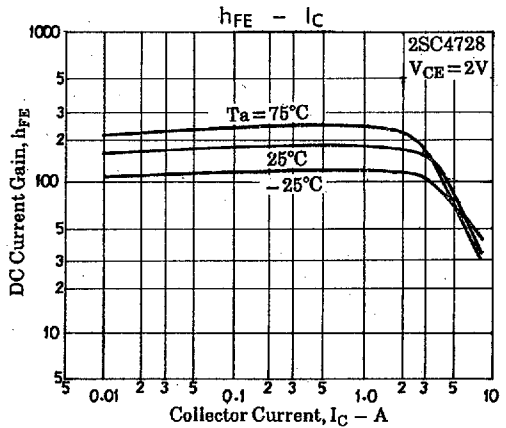
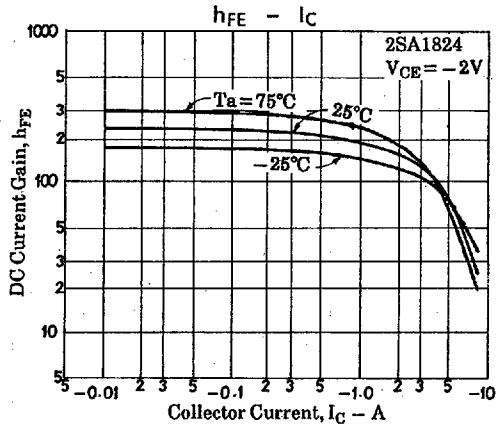
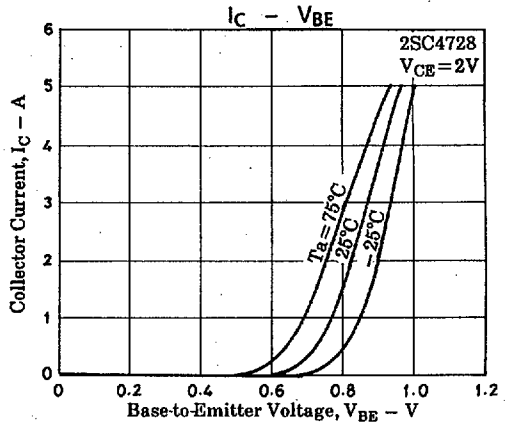
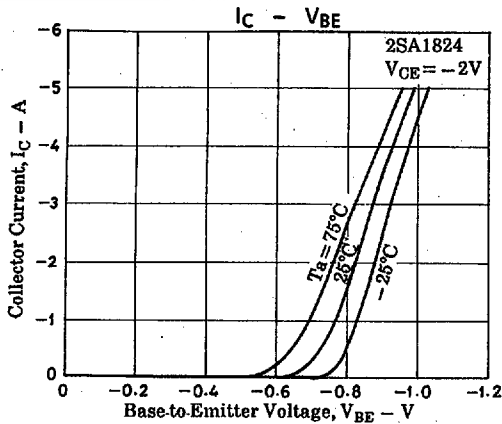

2SA1824/2SC4728

