



40 dB Fixed Attenuator, TNC Male To TNC
 Female Rated To 25 Watts Up To 18 GHz

TECHNICAL DATA SHEET

PE7054-40

40 dB Fixed Attenuator, TNC Male To TNC Female Rated To 25 Watts Up To 18 GHz

Configuration

Design	Fixed, Bidirectional Attenuator
Connector 1	TNC Male
Connector 2	TNC Female

Electrical Specifications

Frequency Range, GHz	DC to 18
Impedance, Ohms	50
Attenuation Value, dB	40
Maximum Input Power, Watts	25
Maximum VSWR	1.4:1

Frequency 1

Range, GHz	DC to 18
VSWR	1.4:1
Attenuation Accuracy, dB	2

Mechanical Specifications

Temperature

Size

Length, in [mm]	4.65 [118.11]
Width, in [mm]	2.65 [67.31]
Height, in [mm]	2.65 [67.31]

Connector 1

Type	TNC Male
Connector Specification	MIL-C-39012

Connector 2

Type	TNC Female
Connector Specification	MIL-C-39012

Compliance Certifications (visit www.Pasternack.com for current document)

RoHS Compliant	Yes
----------------	-----

Plotted and Other Data

Notes: Values at 25 °C, sea level

URL: <http://www.pasternack.com/40db-fixed-tnc-male-tnc-female-25-watts-attenuator-pe7054-40-p.aspx>

40 dB Fixed Attenuator, TNC Male To TNC Female Rated To 25 Watts Up To 18 GHz from Pasternack Enterprises has same day shipment for domestic and International orders. Our RF, microwave and fiber optic products maintain a 99% availability and are part of the broadest selection in the industry.

The information contained in this document is accurate to the best of our knowledge and representative of the part described herein. It may be necessary to make modifications to the part and/or the documentation of the part, in order to implement improvements. Pasternack reserves the right to make such changes as required. Unless otherwise stated, all specifications are nominal.



PE7054-40 CAD Drawing

40 dB Fixed Attenuator, TNC Male To TNC Female Rated To 25 Watts Up To 18 GHz

P/N	ATTEN.	FIGURE
PE7054-1	1 dB	1
PE7054-2	2 dB	1
PE7054-3	3 dB	1
PE7054-6	6 dB	1
PE7054-10	10 dB	1
PE7054-20	20 dB	1
PE7054-30	30 dB	1
PE7054-40	40 dB	1

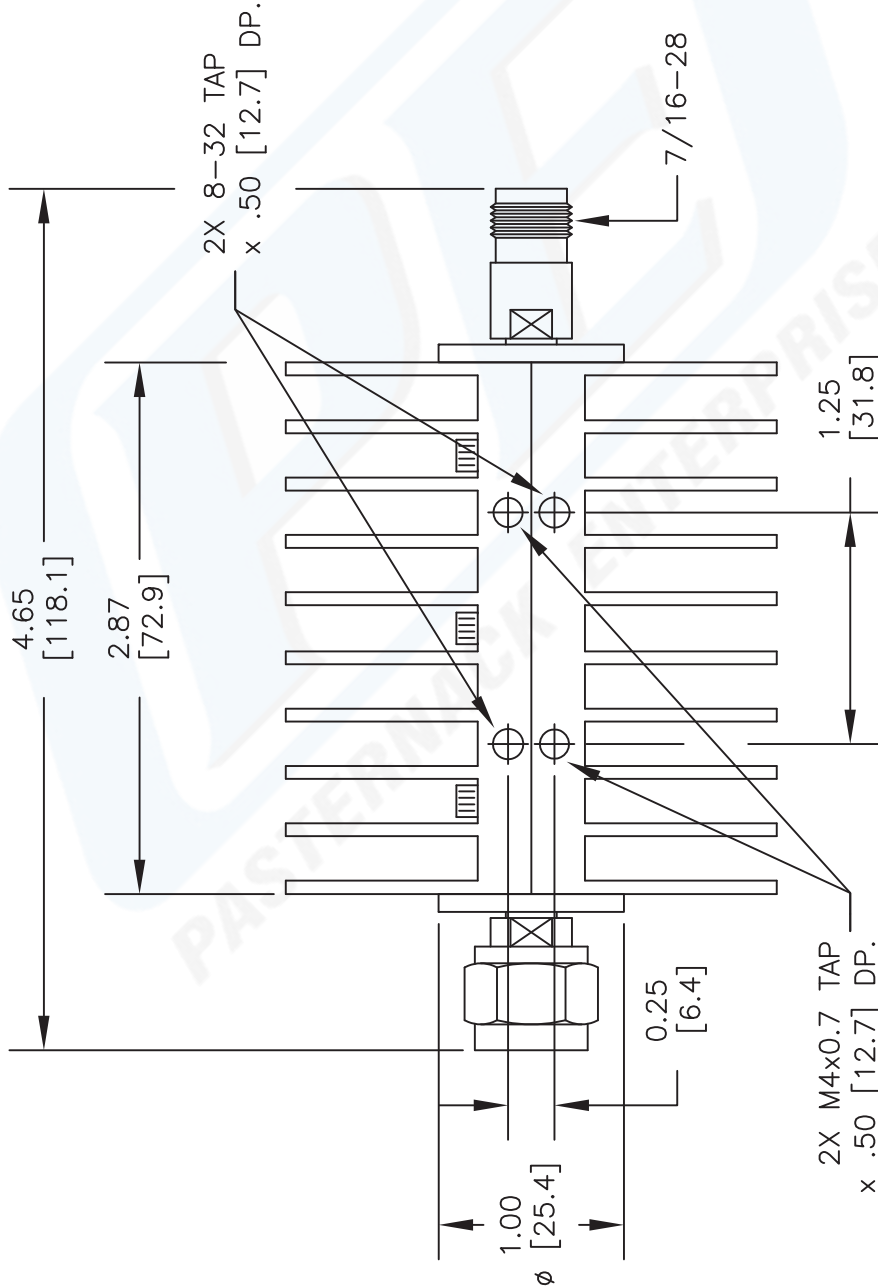

TNC FEMALE

TNC MALE

FIGURE 1

DWG TITLE

PE7054

NOTES:
 1. UNLESS OTHERWISE SPECIFIED ALL DIMENSIONS ARE NOMINAL.
 2. ALL SPECIFICATIONS ARE SUBJECT TO CHANGE WITHOUT NOTICE AT ANY TIME.
 3. DIMENSIONS ARE IN INCHES [mm].

FSCM NO. 53919

CAD FILE 012313

SCALE N/A

SIZE A

2233

PE PASTERNAK®
 Pasternack Enterprises, Inc.
 P.O. Box 16759 | Irvine | CA | 92623

Phone: (949) 261-1920 | Fax: (949) 261-7451

Website: www.pasternack.com | E-Mail: sales@pasternack.com