

# 2SD2242, 2SD2242A

Silicon NPN triple diffusion planar type Darlington

For power amplification

## Features

- High forward current transfer ratio  $h_{FE}$
- High-speed switching
- Allowing supply with the radial taping

## Absolute Maximum Ratings ( $T_C=25^\circ\text{C}$ )

Parameter	Symbol	Ratings	Unit	
Collector to base voltage	2SD2242	60	V	
	2SD2242A	80		
Collector to emitter voltage	2SD2242	60	V	
	2SD2242A	80		
Emitter to base voltage	$V_{EBO}$	5	V	
Peak collector current	$I_{CP}$	8	A	
Collector current	$I_C$	4	A	
Collector power dissipation	$P_C$	$T_C=25^\circ\text{C}$	15	W
		$T_a=25^\circ\text{C}$	2	
Junction temperature	$T_j$	150	$^\circ\text{C}$	
Storage temperature	$T_{stg}$	-55 to +150	$^\circ\text{C}$	

## Electrical Characteristics ( $T_C=25^\circ\text{C}$ )

Parameter	Symbol	Conditions	min	typ	max	Unit
Collector cutoff current	2SD2242	$I_{CBO}$	$V_{CB} = 60\text{V}, I_E = 0$		200	$\mu\text{A}$
	2SD2242A					
Collector cutoff current	2SD2242	$I_{CEO}$	$V_{CE} = 30\text{V}, I_B = 0$		500	$\mu\text{A}$
	2SD2242A					
Emitter cutoff current	$I_{EBO}$	$V_{EB} = 5\text{V}, I_C = 0$			2	mA
Collector to emitter voltage	2SD2242	$V_{CEO}$	$I_C = 30\text{mA}, I_B = 0$	60		V
	2SD2242A			80		
Forward current transfer ratio	$h_{FE1}$	$V_{CE} = 3\text{V}, I_C = 0.5\text{A}$	1000			
	$h_{FE2}^*$	$V_{CE} = 3\text{V}, I_C = 3\text{A}$	2000		10000	
Base to emitter voltage	$V_{BE}$	$V_{CE} = 3\text{V}, I_C = 3\text{A}$			2.5	V
Collector to emitter saturation voltage	$V_{CE(sat)}$	$I_C = 3\text{A}, I_B = 12\text{mA}$			2	V
		$I_C = 5\text{A}, I_B = 20\text{mA}$			4	
Transition frequency	$f_T$	$V_{CE} = 10\text{V}, I_C = 0.5\text{A}, f = 1\text{MHz}$		20		MHz
Turn-on time	$t_{on}$	$I_C = 3\text{A}, I_{B1} = 12\text{mA}, I_{B2} = -12\text{mA}, V_{CC} = 50\text{V}$		0.5		$\mu\text{s}$
Storage time	$t_{stg}$			4		$\mu\text{s}$
Fall time	$t_f$			1		$\mu\text{s}$

\* $h_{FE2}$  Rank classification

Rank	Q	P
$h_{FE2}$	2000 to 5000	4000 to 10000

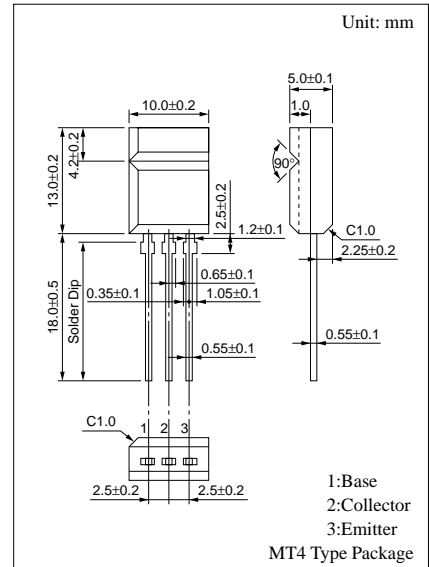

## Internal Connection

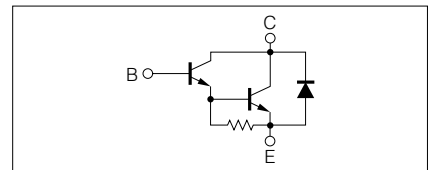

$P_C - T_a$

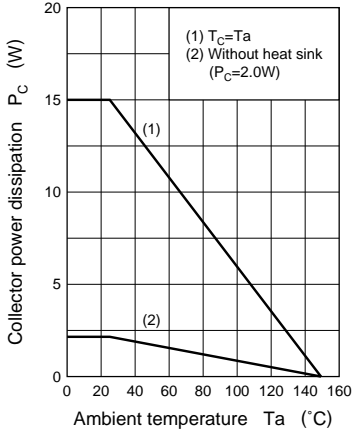

$I_C - V_{CE}$

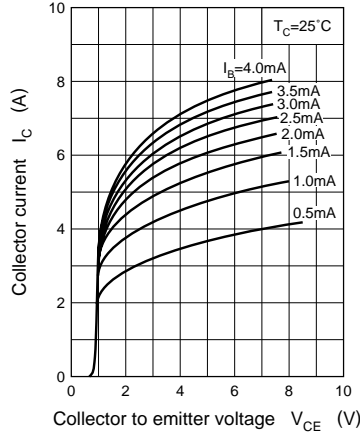

$I_C - V_{BE}$

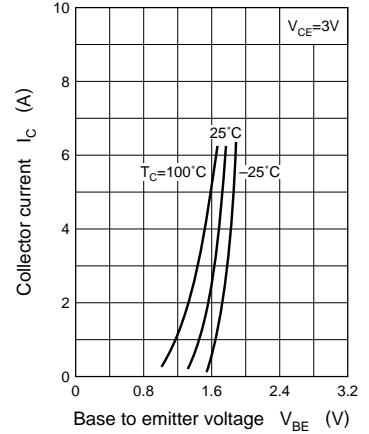

$V_{CE(sat)} - I_C$

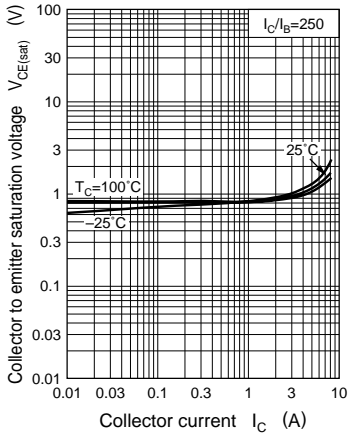

$h_{FE} - I_C$

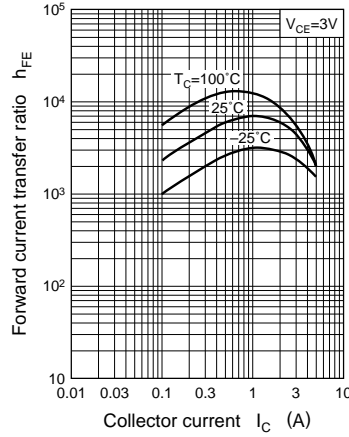

$C_{ob} - V_{CB}$

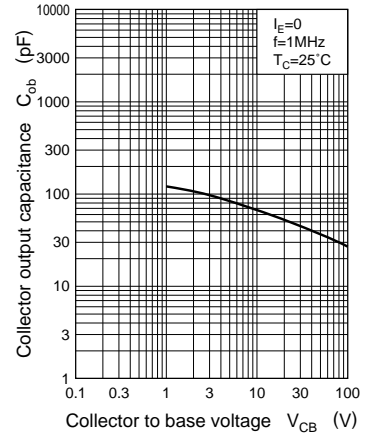

Area of safe operation (ASO)

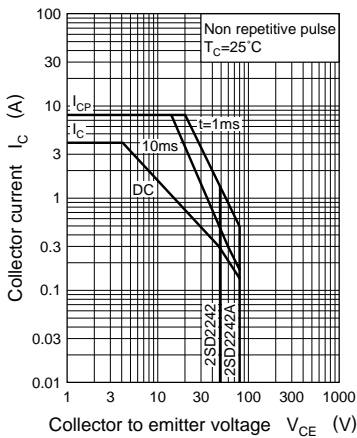

$R_{th(t)} - t$

