



Precision Low Noise CMOS Rail-to-Rail Input/Output Operational Amplifiers

AD8605/AD8606/AD8608*

FEATURES

- Low Offset Voltage: 65 μV Max
- Low Input Bias Currents: 1 pA Max
- Low Noise: 8 $\text{nV}/\sqrt{\text{Hz}}$
- Wide Bandwidth: 10 MHz
- High Open-Loop Gain: 120 dB
- Unity Gain Stable
- Single-Supply Operation: 2.7 V to 6 V

APPLICATIONS

- Photodiode Amplification
- Battery-Powered Instrumentation
- Multipole Filters
- Sensors
- Barcode Scanners
- Audio

GENERAL DESCRIPTION

The AD8605, AD8606, and AD8608 are single, dual, and quad rail-to-rail input and output, single-supply amplifiers that feature very low offset voltage, low input voltage and current noise, and wide signal bandwidth. They use Analog Devices' patented DigiTrim[®] trimming technique, which achieves superior precision without laser trimming.

The combination of low offsets, low noise, very low input bias currents, and high speed makes these amplifiers useful in a wide variety of applications. Filters, integrators, photodiode amplifiers, and high impedance sensors all benefit from the combination of performance features. Audio and other ac applications benefit from the wide bandwidth and low distortion. Applications for these amplifiers include optical control loops, portable and loop-powered instrumentation, and audio amplification for portable devices.

The AD8605, AD8606, and AD8608 are specified over the extended industrial (-40°C to $+125^{\circ}\text{C}$) temperature range. The AD8605 single is available in the tiny 5-lead SOT-23 package. The AD8606 dual is available in an 8-lead MSOP and a narrow SOIC surface-mount package. The AD8608 quad is available in a 14-lead TSSOP and a narrow 14-lead SOIC package. SOT, MSOP, and TSSOP versions are available in tape and reel only.

FUNCTIONAL BLOCK DIAGRAMS

5-Lead SOT-23
(RT Suffix)

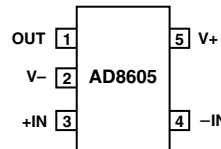

14-Lead TSSOP
(RU Suffix)

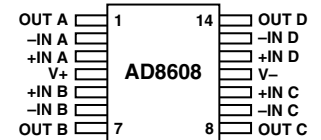

8-Lead MSOP
(RM Suffix)

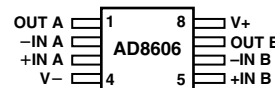

14-Lead SOIC
(RN Suffix)

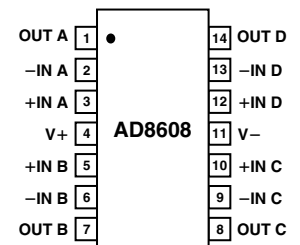

8-Lead SOIC
(RN Suffix)

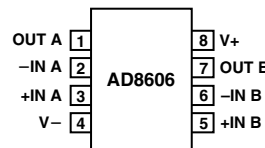

*Protected by U.S. Patent No. 5,969,657; other patents pending. DigiTrim is a registered trademark of Analog Devices, Inc.

REV. A

Information furnished by Analog Devices is believed to be accurate and reliable. However, no responsibility is assumed by Analog Devices for its use, nor for any infringements of patents or other rights of third parties that may result from its use. No license is granted by implication or otherwise under any patent or patent rights of Analog Devices.

AD8605/AD8606/AD8608—SPECIFICATIONS

ELECTRICAL CHARACTERISTICS (@ $V_S = 5\text{ V}$, $V_{CM} = V_S/2$, $T_A = 25^\circ\text{C}$, unless otherwise noted.)

Parameter	Symbol	Conditions	Min	Typ	Max	Unit		
INPUT CHARACTERISTICS								
Offset Voltage	V_{OS}	$V_S = 3.5\text{ V}$, $V_{CM} = 3\text{ V}$ $V_S = 3.5\text{ V}$, $V_{CM} = 2.7\text{ V}$ $V_S = 5\text{ V}$, $V_{CM} = 0\text{ V to } 5\text{ V}$ $-40^\circ\text{C} < T_A < +125^\circ\text{C}$		20	65	μV		
AD8605/AD8606				20	75	μV		
AD8608				80	300	μV		
						750	μV	
Input Bias Current	I_B	$-40^\circ\text{C} < T_A < +85^\circ\text{C}$ $-40^\circ\text{C} < T_A < +125^\circ\text{C}$ $-40^\circ\text{C} < T_A < +85^\circ\text{C}$ $-40^\circ\text{C} < T_A < +125^\circ\text{C}$		0.2	1	pA		
AD8605/AD8606						50	pA	
AD8605/AD8606							250	pA
AD8608							100	pA
AD8608						300	pA	
Input Offset Current	I_{OS}	$-40^\circ\text{C} < T_A < +85^\circ\text{C}$ $-40^\circ\text{C} < T_A < +125^\circ\text{C}$		0.1	0.5	pA		
							20	pA
							75	pA
Input Voltage Range			0		5	V		
Common-Mode Rejection Ratio	CMRR	$V_{CM} = 0\text{ V to } 5\text{ V}$ $-40^\circ\text{C} < T_A < +125^\circ\text{C}$	85	100		dB		
			75	90		dB		
Large Signal Voltage Gain	A_{VO}	$V_O = 0.5\text{ V to } 4.5\text{ V}$ $R_L = 2\text{ k}\Omega$, $V_{CM} = 0\text{ V}$	300	1,000		V/mV		
Offset Voltage Drift	$\Delta V_{OS}/\Delta T$			1	4.5	$\mu\text{V}/^\circ\text{C}$		
AD8605/AD8606					1.5	6.0	$\mu\text{V}/^\circ\text{C}$	
AD8608						$\mu\text{V}/^\circ\text{C}$		
INPUT CAPACITANCE								
Common-Mode Input Capacitance				8.8		pF		
Differential Input Capacitance				2.59		pF		
OUTPUT CHARACTERISTICS								
Output Voltage High	V_{OH}	$I_L = 1\text{ mA}$ $I_L = 10\text{ mA}$ $-40^\circ\text{C} < T_A < +125^\circ\text{C}$	4.96	4.98		V		
				4.7	4.79		V	
				4.6			V	
Output Voltage Low	V_{OL}	$I_L = 1\text{ mA}$ $I_L = 10\text{ mA}$ $-40^\circ\text{C} < T_A < +125^\circ\text{C}$		20	40	mV		
					170	210	mV	
						290	mV	
Output Current	I_{OUT}			± 80		mA		
Closed-Loop Output Impedance	Z_{OUT}	$f = 1\text{ MHz}$, $A_V = 1$		10		Ω		
POWER SUPPLY								
Power Supply Rejection Ratio	PSRR	$V_S = 2.7\text{ V to } 5.5\text{ V}$ $V_S = 2.7\text{ V to } 5.5\text{ V}$ $-40^\circ\text{C} < T_A < +125^\circ\text{C}$	80	95		dB		
AD8605/AD8606				77	92		dB	
AD8608				70	90		dB	
Supply Current/Amplifier	I_{SY}	$V_O = 0\text{ V}$ $-40^\circ\text{C} < T_A < +125^\circ\text{C}$		1	1.2	mA		
					1.4	mA		
DYNAMIC PERFORMANCE								
Slew Rate	SR	$R_L = 2\text{ k}\Omega$		5		V/ μs		
Settling Time	t_s	To 0.01%, 0 V to 2 V step		< 1		μs		
Full Power Bandwidth	BW _p	< 1% Distortion		360		kHz		
Gain Bandwidth Product	GBP			10		MHz		
Phase Margin	$\angle O$			65		Degrees		
NOISE PERFORMANCE								
Peak-to-Peak Noise	$e_n\text{ p-p}$	$f = 0.1\text{ Hz to } 10\text{ Hz}$		2.3	3.5	$\mu\text{V p-p}$		
Voltage Noise Density	e_n	$f = 1\text{ kHz}$		8	12	$\text{nV}/\sqrt{\text{Hz}}$		
Voltage Noise Density	e_n	$f = 10\text{ kHz}$		6.5		$\text{nV}/\sqrt{\text{Hz}}$		
Current Noise Density	i_n	$f = 1\text{ kHz}$		0.01		$\text{pA}/\sqrt{\text{Hz}}$		

ELECTRICAL CHARACTERISTICS (@ $V_S = 2.7\text{ V}$, $V_{CM} = V_S/2$, $T_A = 25^\circ\text{C}$, unless otherwise noted.)

Parameter	Symbol	Conditions	Min	Typ	Max	Unit	
INPUT CHARACTERISTICS							
Offset Voltage	V_{OS}	$V_S = 3.5\text{ V}$, $V_{CM} = 3\text{ V}$		20	65	μV	
AD8605/AD8606		$V_S = 3.5\text{ V}$, $V_{CM} = 2.7\text{ V}$		20	75	μV	
AD8608		$V_S = 2.7\text{ V}$, $V_{CM} = 0\text{ V to } 2.7\text{ V}$		80	300	μV	
		$-40^\circ\text{C} < T_A < +125^\circ\text{C}$				750	μV
Input Bias Current	I_B			0.2	1	pA	
AD8605/AD8606		$-40^\circ\text{C} < T_A < +85^\circ\text{C}$			50	pA	
AD8605/AD8606		$-40^\circ\text{C} < T_A < +125^\circ\text{C}$				250	pA
AD8608		$-40^\circ\text{C} < T_A < +85^\circ\text{C}$				100	pA
AD8608		$-40^\circ\text{C} < T_A < +125^\circ\text{C}$				300	pA
Input Offset Current	I_{OS}			0.1	0.5	pA	
		$-40^\circ\text{C} < T_A < +85^\circ\text{C}$				20	pA
		$-40^\circ\text{C} < T_A < +125^\circ\text{C}$				75	pA
Input Voltage Range			0		2.7	V	
Common-Mode Rejection Ratio	$CMRR$	$V_{CM} = 0\text{ V to } 2.7\text{ V}$	80	95		dB	
		$-40^\circ\text{C} < T_A < +125^\circ\text{C}$		70	85		dB
Large Signal Voltage Gain	A_{VO}	$R_L = 2\text{ k}\Omega$, $V_O = 0.5\text{ V to } 2.2\text{ V}$	110	350		V/mV	
Offset Voltage Drift	$\Delta V_{OS}/\Delta T$			1	4.5	$\mu\text{V}/^\circ\text{C}$	
AD8605/AD8606					1.5	6.0	$\mu\text{V}/^\circ\text{C}$
AD8608							
INPUT CAPACITANCE							
Common-Mode Input Capacitance				8.8		pF	
Differential Input Capacitance				2.59		pF	
OUTPUT CHARACTERISTICS							
Output Voltage High	V_{OH}	$I_L = 1\text{ mA}$	2.6	2.66		V	
		$-40^\circ\text{C} < T_A < +125^\circ\text{C}$		2.6			V
Output Voltage Low	V_{OL}	$I_L = 1\text{ mA}$		25	40	mV	
		$-40^\circ\text{C} < T_A < +125^\circ\text{C}$				50	mV
Output Current	I_{OUT}			± 30		mA	
Closed-Loop Output Impedance	Z_{OUT}	$f = 1\text{ MHz}$, $A_V = 1$		12		Ω	
POWER SUPPLY							
Power Supply Rejection Ratio	$PSRR$	$V_S = 2.7\text{ V to } 5.5\text{ V}$	80	95		dB	
AD8605/AD8606		$V_S = 2.7\text{ V to } 5.5\text{ V}$	77	92		dB	
AD8608		$-40^\circ\text{C} < T_A < +125^\circ\text{C}$	70	90		dB	
		$V_O = 0\text{ V}$			1.15	1.4	mA
Supply Current/Amplifier	I_{SY}	$-40^\circ\text{C} < T_A < +125^\circ\text{C}$			1.5	mA	
DYNAMIC PERFORMANCE							
Slew Rate	SR	$R_L = 2\text{ k}\Omega$		5		$\text{V}/\mu\text{s}$	
Settling Time	t_s	To 0.01%, 0 V to 1 V step		< 0.5		μs	
Gain Bandwidth Product	GBP			9		MHz	
Phase Margin	\angle_O			50		Degrees	
NOISE PERFORMANCE							
Peak-to-Peak Noise	$e_n\text{ p-p}$	$f = 0.1\text{ Hz to } 10\text{ Hz}$		2.3	3.5	$\mu\text{V p-p}$	
Voltage Noise Density	e_n	$f = 1\text{ kHz}$		8	12	$\text{nV}/\sqrt{\text{Hz}}$	
Voltage Noise Density	e_n	$f = 10\text{ kHz}$		6.5		$\text{nV}/\sqrt{\text{Hz}}$	
Current Noise Density	i_n	$f = 1\text{ kHz}$		0.01		$\text{pA}/\sqrt{\text{Hz}}$	

AD8605/AD8606/AD8608

ABSOLUTE MAXIMUM RATINGS*

Supply Voltage	6 V
Input Voltage	GND to V_S
Differential Input Voltage	6 V
Output Short-Circuit Duration to GND	Observe Derating Curves
Storage Temperature Range RN, RT, RM, RU Packages	-65°C to +150°C
Operating Temperature Range AD8605/AD8606/AD8608	-40°C to +125°C
Junction Temperature Range RN, RT, RM, RU Packages	-65°C to +150°C
Lead Temperature Range (Soldering, 60 sec)	300°C

*Stresses above those listed under Absolute Maximum Ratings may cause permanent damage to the device. This is a stress rating only; functional operation of the device at these or any other conditions above those listed in the operational sections of this specification is not implied. Exposure to absolute maximum rating conditions for extended periods may affect device reliability.

Package Type	θ_{JA} *	θ_{JC}	Unit
5-Lead SOT-23 (RT)	230	92	°C/W
8-Lead MSOP (RM)	210	45	°C/W
8-Lead SOIC (RN)	158	43	°C/W
14-Lead SOIC (RN)	120	36	°C/W
14-Lead TSSOP (RU)	180	35	°C/W

* θ_{JA} is specified for worst-case conditions, i.e., θ_{JA} is specified for device in socket for PDIP packages; θ_{JA} is specified for device soldered onto a circuit board for surface-mount packages.

ORDERING GUIDE

Model	Temperature Range	Package Description	Package Option	Branding Information
AD8605ART	-40°C to +125°C	5-Lead SOT-23	RT-5	B3A
AD8606ARM	-40°C to +125°C	8-Lead MSOP	RM-8	B6A
AD8606ARN	-40°C to +125°C	8-Lead SOIC	RN-8	
AD8608ARN	-40°C to +125°C	14-Lead SOIC	RN-14	
AD8608ARU	-40°C to +125°C	14-Lead TSSOP	RU-14	

CAUTION

ESD (electrostatic discharge) sensitive device. Electrostatic charges as high as 4000 V readily accumulate on the human body and test equipment and can discharge without detection. Although the AD8605/AD8606/AD8608 features proprietary ESD protection circuitry, permanent damage may occur on devices subjected to high energy electrostatic discharges. Therefore, proper ESD precautions are recommended to avoid performance degradation or loss of functionality.



Typical Performance Characteristics—AD8605/AD8606/AD8608

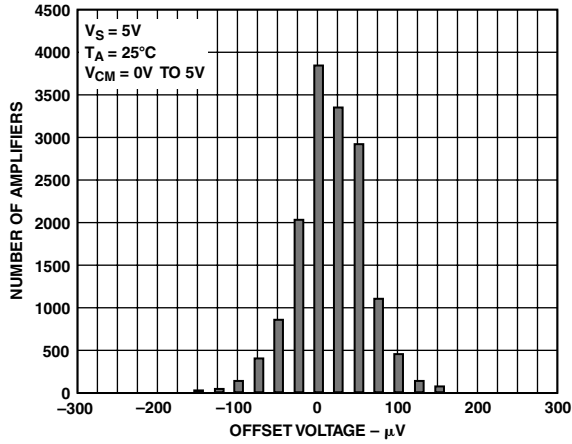

TPC 1. Input Offset Voltage Distribution

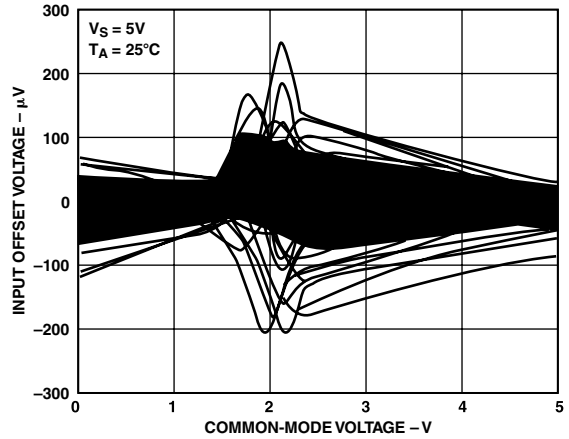

TPC 4. Input Offset Voltage vs. Common-Mode Voltage (200 Units, 5 Wafer Lots, Including Process Skews)

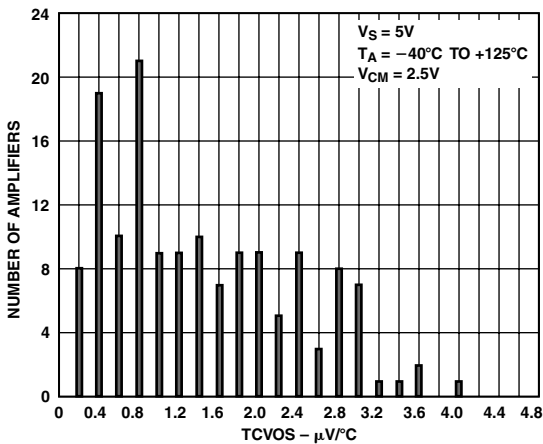

TPC 2. AD8608 Input Offset Voltage Drift Distribution

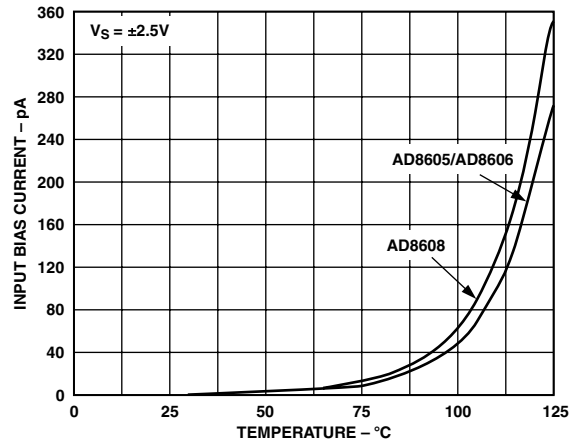

TPC 5. Input Bias Current vs. Temperature

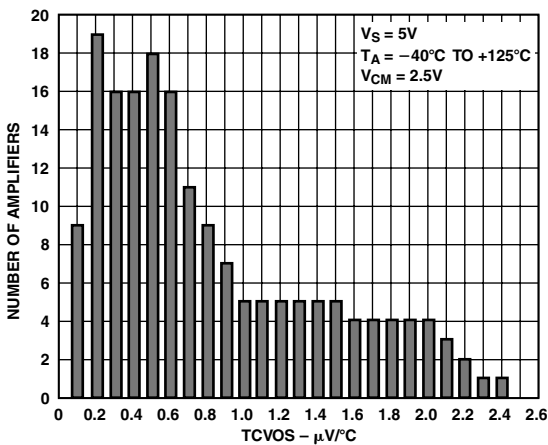

TPC 3. AD8605/AD8606 Input Offset Voltage Drift Distribution

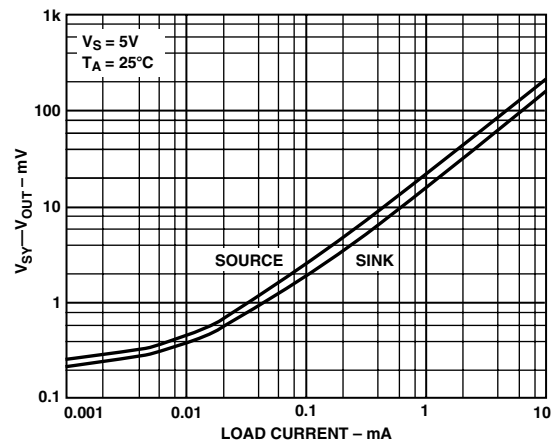

TPC 6. Output Voltage to Supply Rail vs. Load Current

AD8605/AD8606/AD8608

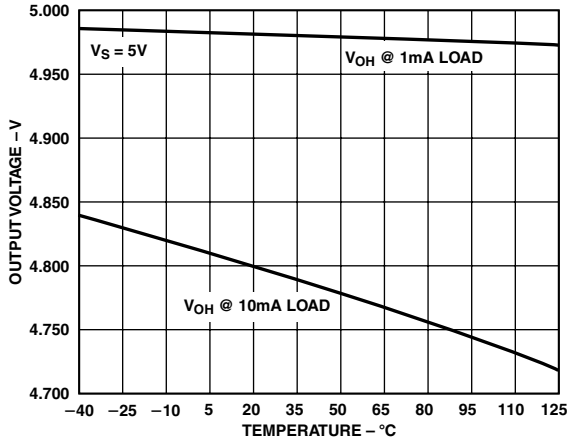

TPC 7. Output Voltage Swing vs. Temperature

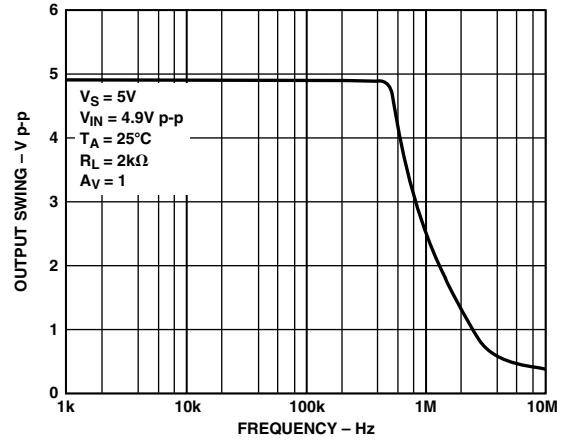

TPC 10. Closed-Loop Output Voltage Swing

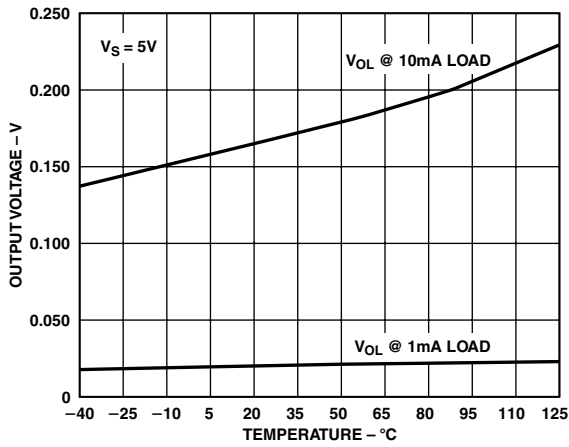

TPC 8. Output Voltage Swing vs. Temperature

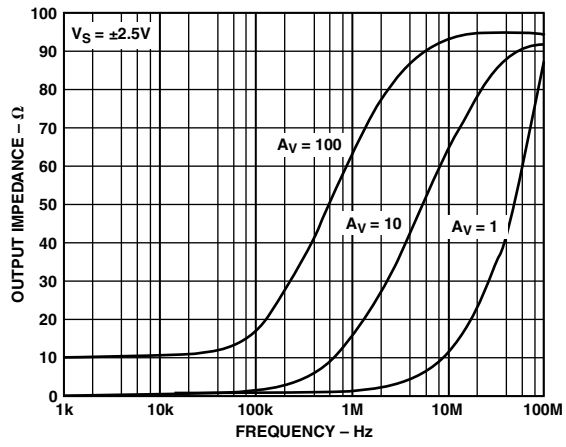

TPC 11. Output Impedance vs. Frequency

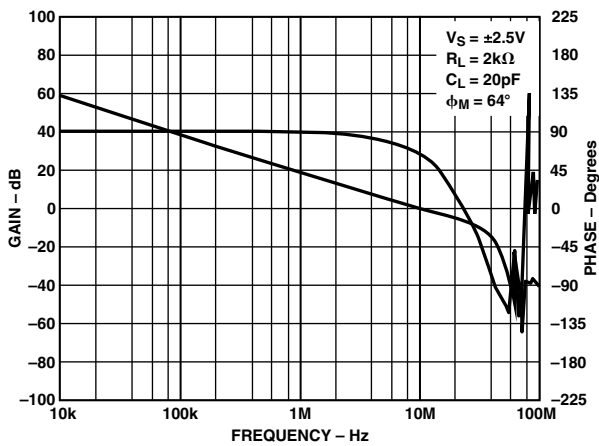

TPC 9. Open-Loop Gain and Phase vs. Frequency

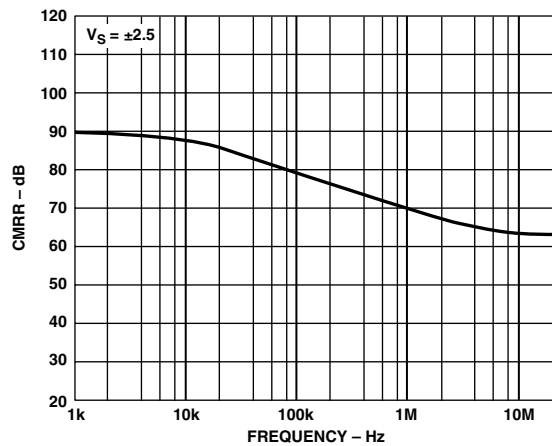

TPC 12. Common-Mode Rejection Ratio vs. Frequency

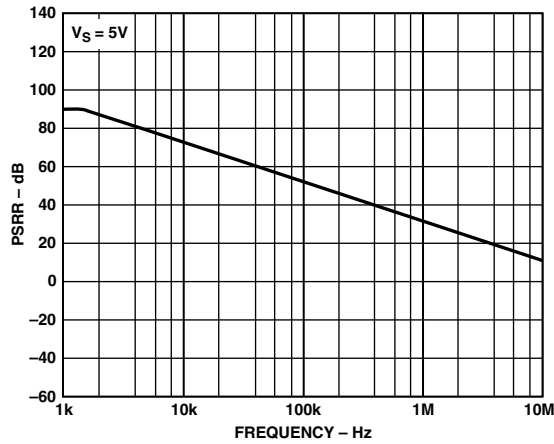

TPC 13. PSRR vs. Frequency

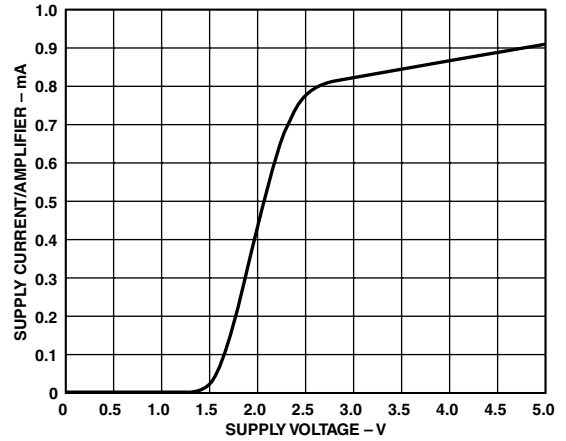

TPC 16. Supply Current vs. Supply Voltage

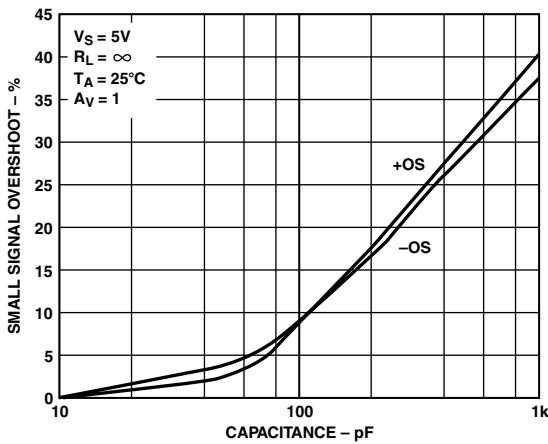

TPC 14. Small Signal Overshoot vs. Load Capacitance

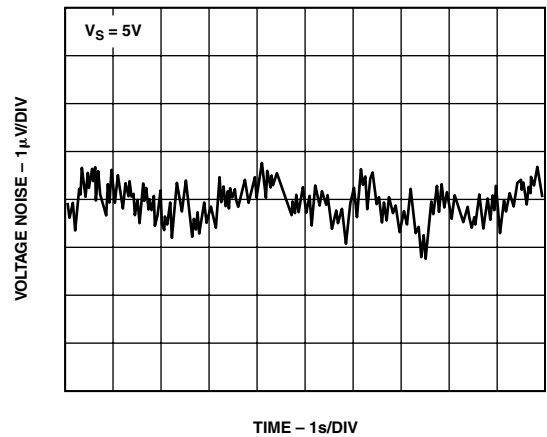

TPC 17. 0.1 Hz to 10 Hz Input Voltage Noise

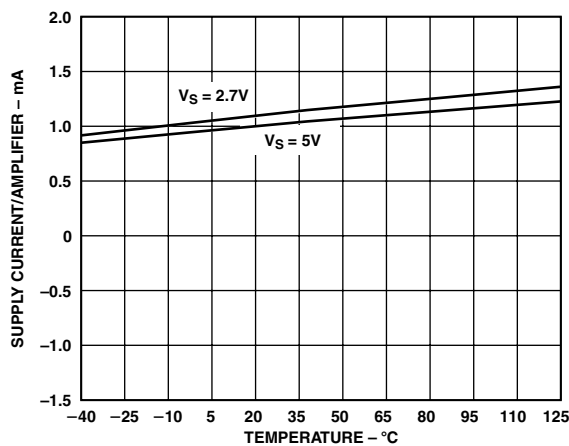

TPC 15. Supply Current vs. Temperature

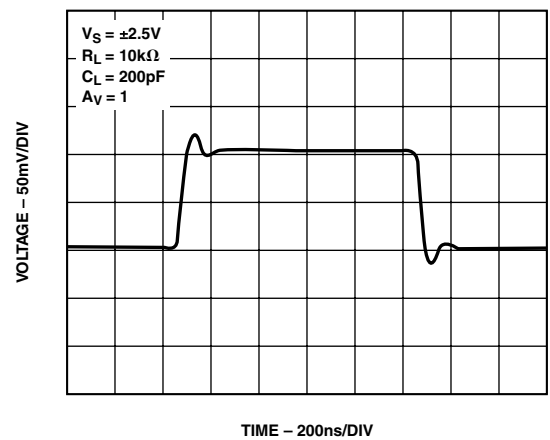

TPC 18. Small Signal Transient Response

AD8605/AD8606/AD8608

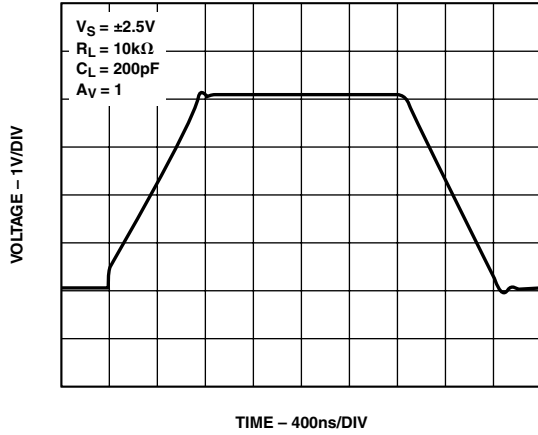

TPC 19. Large Signal Transient Response

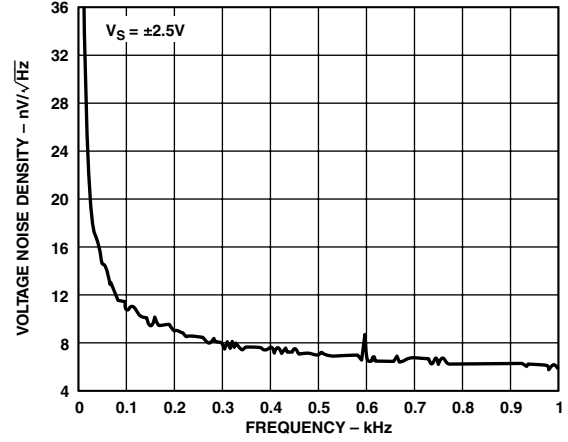

TPC 22. Voltage Noise Density

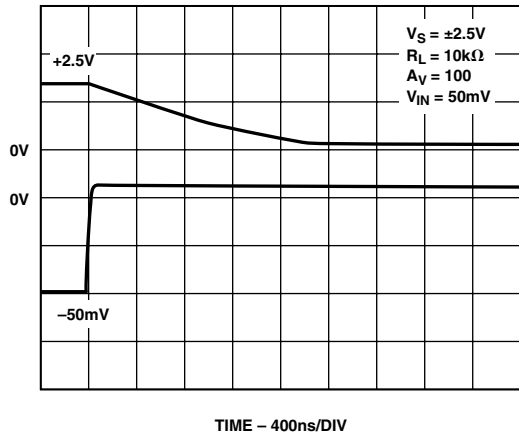

TPC 20. Negative Overload Recovery

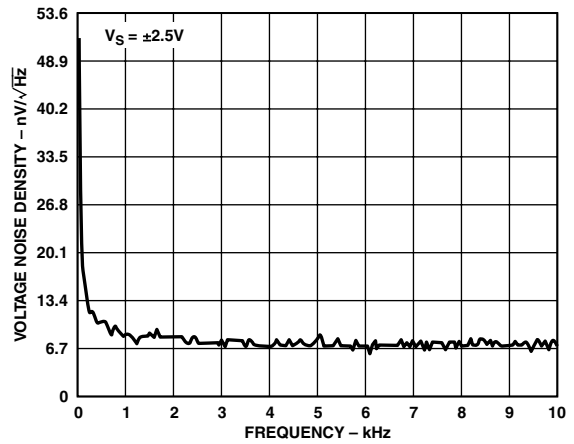

TPC 23. Voltage Noise Density

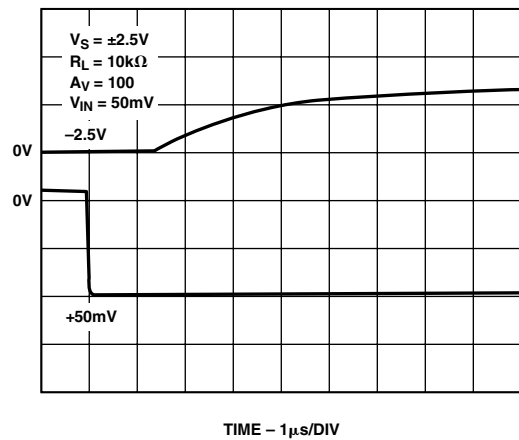

TPC 21. Positive Overload Recovery

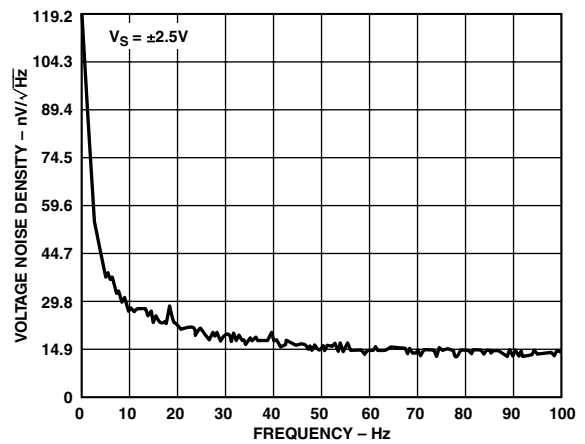

TPC 24. Voltage Noise Density

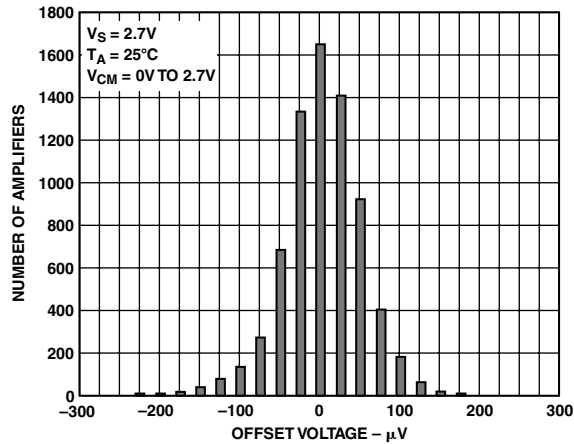

TPC 25. Input Offset Voltage Distribution

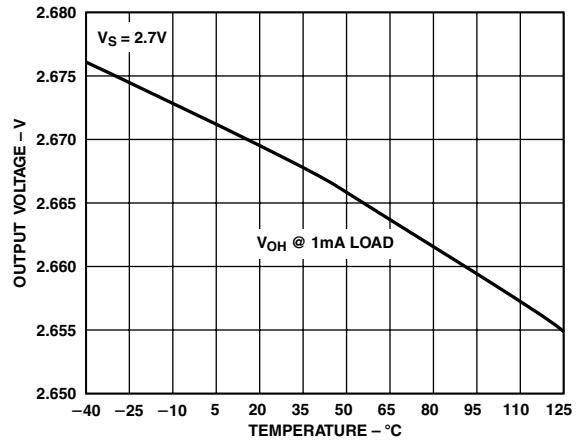

TPC 28. Output Voltage Swing vs. Temperature

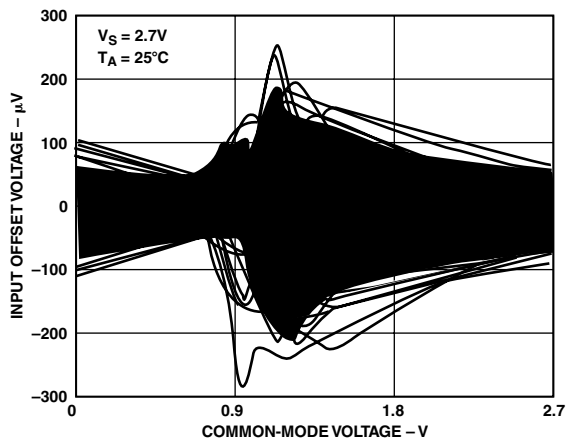

TPC 26. Input Offset Voltage vs. Common-Mode Voltage (200 Units, 5 Wafer Lots, Including Process Skews)

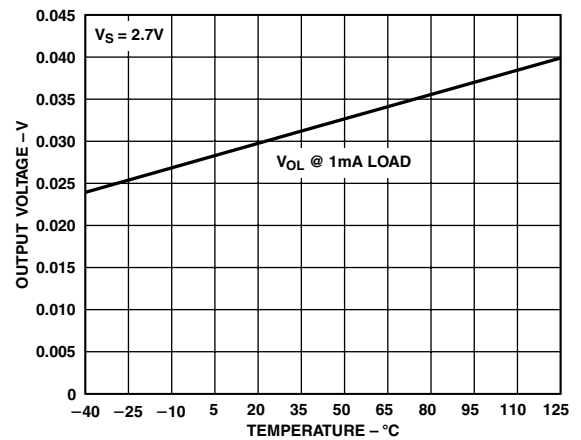

TPC 29. Output Voltage Swing vs. Temperature

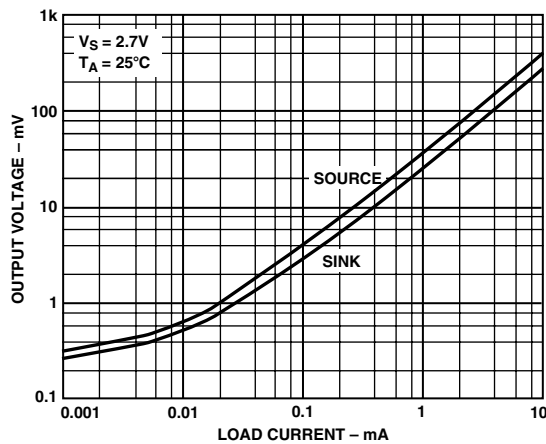

TPC 27. Output Voltage to Supply Rail vs. Load Current

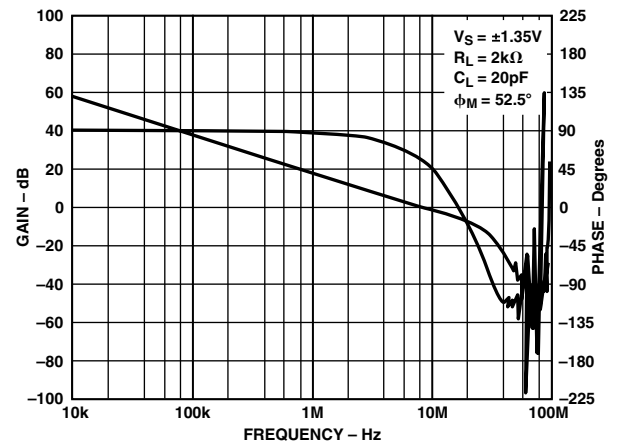

TPC 30. Open-Loop Gain and Phase vs. Frequency

AD8605/AD8606/AD8608

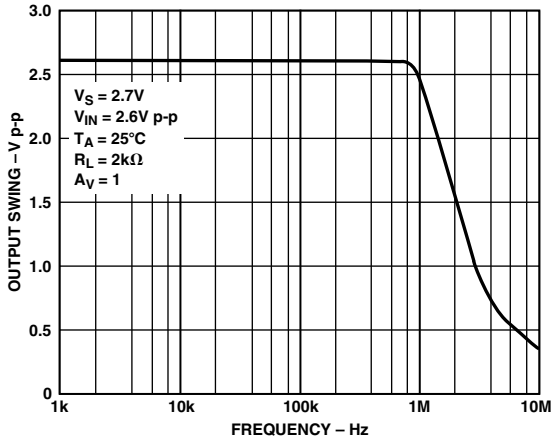

TPC 31. Closed-Loop Output Voltage Swing vs. Frequency

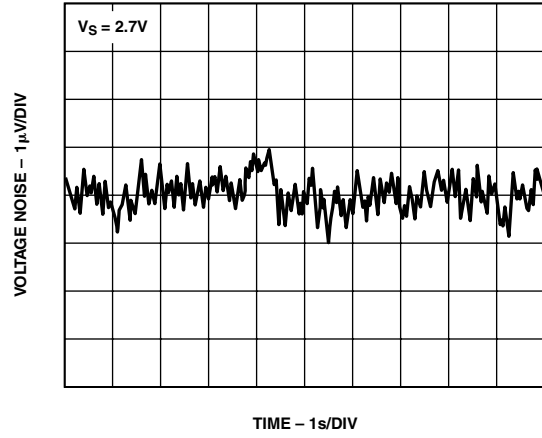

TPC 34. 0.1 Hz to 10 Hz Input Voltage Noise

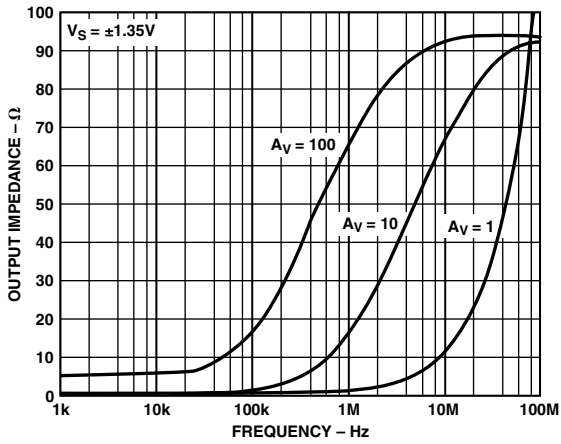

TPC 32. Output Impedance vs. Frequency

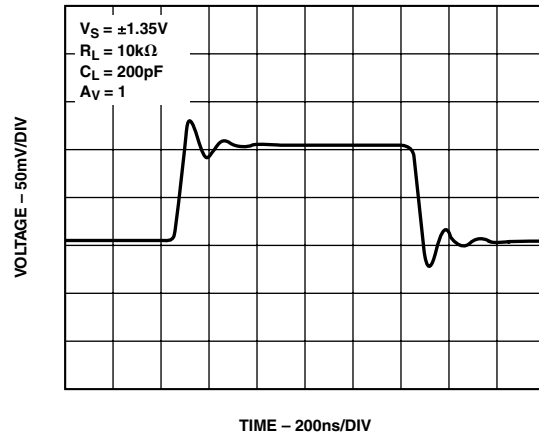

TPC 35. Small Signal Transient Response

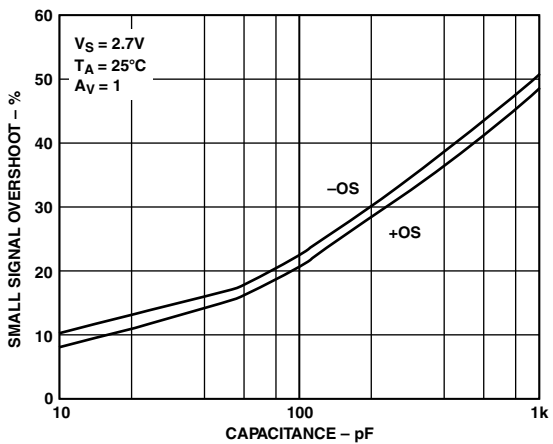

TPC 33. Small Signal Overshoot vs. Load Capacitance

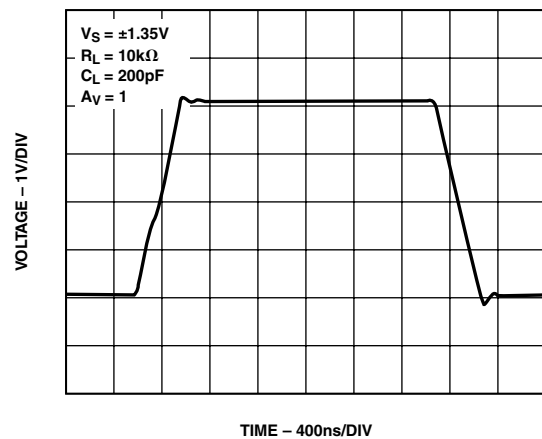

TPC 36. Large Signal Transient Response

Output Phase Reversal

Phase reversal is defined as a change in polarity at the output of the amplifier when a voltage that exceeds the maximum input common-mode voltage drives the input.

Phase reversal can cause permanent damage to the amplifier; it may also cause system lockups in feedback loops. The AD8605 does not exhibit phase reversal even for inputs exceeding the supply voltage by more than 2 V.

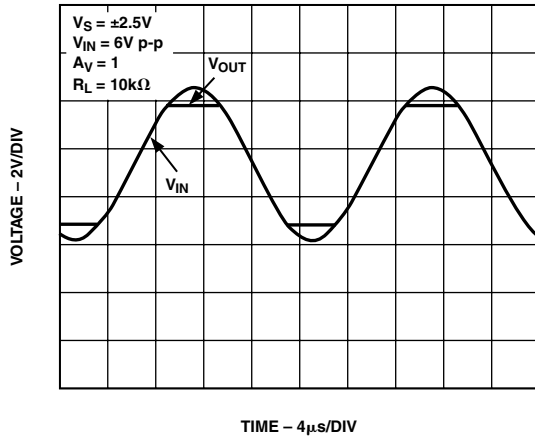

Figure 1. No Phase Reversal

Maximum Power Dissipation

Power dissipated in an IC will cause the die temperature to increase. This can affect the behavior of the IC and the application circuit performance.

The absolute maximum junction temperature of the AD8605/AD8606/AD8608 is 150°C.

Exceeding this temperature could cause damage or destruction of the device.

The maximum power dissipation of the amplifier is calculated according to the following formula:

$$P_{DISS} = \frac{(T_A - T_C)}{\theta_{JA} - \theta_{JC}}$$

where:

- T_A = ambient temperature
- T_C = case temperature (device)
- θ_{JC} = junction to case thermal resistance
- θ_{JA} = junction to ambient thermal resistance

Figure 2 shows the maximum power dissipation versus the temperature for the various packages available for the AD8605 family.

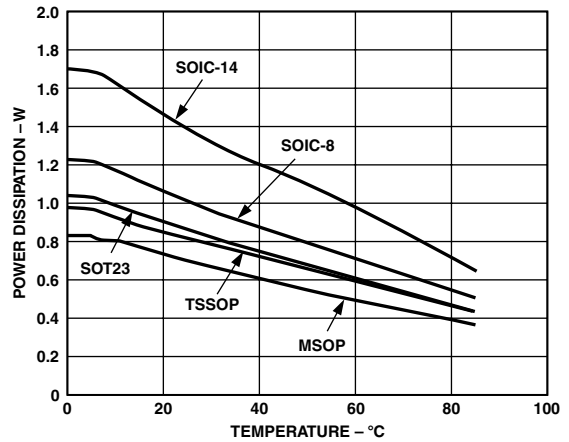

Figure 2. Maximum Power Dissipation vs. Temperature

Input Overvoltage Protection

The AD8605 has internal protective circuitry. However, if the voltage applied at either input exceeds the supplies by more than 2.5 V, external resistors should be placed in series with the inputs. The resistor values can be determined according to the formula:

$$\frac{(V_{IN} - V_S)}{(R_S + 200\Omega)} \leq 5mA$$

The remarkable low input offset current of the AD8605 (<1 pA) allows the use of larger value resistors. With a 10 kΩ resistor at the input, the output voltage will have less than 10 nV of error voltage. A 10 kΩ resistor has less than 13 nV/√Hz of thermal noise at room temperature.

THD + Noise

Total harmonic distortion is the ratio of the input signal in V rms to the total harmonics in V rms throughout the spectrum. Harmonic distortion adds errors to precision measurements and adds unpleasant sonic artifacts to audio systems.

The AD8605 has a low total harmonic distortion. Figure 3 shows that the AD8605 has less than 0.005% or –86 dB of THD + N over the entire audio frequency range. The AD8605 is configured in positive unity gain, which is the worst case, and with a load of 10 kΩ.

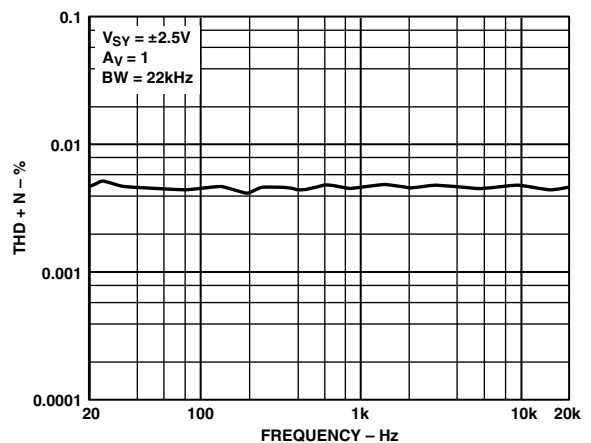

Figure 3. THD + N

AD8605/AD8606/AD8608

Total Noise Including Source Resistors

The low input current noise and input bias current of the AD8605 make it the ideal amplifier for circuits with substantial input source resistance such as photodiodes. Input offset voltage increases by less than 0.5 nV per 1 kΩ of source resistance at room temperature, increasing to 10 nV at 85°C.

The total noise density of the circuit is:

$$e_{n,TOTAL} = \sqrt{e_n^2 + (i_n R_S)^2 + 4kTR_S}$$

Where:

- e_n is the input voltage noise density of the AD8605
- i_n is the input current noise density of the AD8605
- R_S is the source resistance at the noninverting terminal
- k is Boltzman's constant (1.38×10^{-23} J/K)
- T is the ambient temperature in Kelvin ($T = 273 + ^\circ\text{C}$)

For example with $R_S = 10$ kΩ, the total voltage noise density is roughly 15 nV/√Hz.

For $R_S < 3.9$ kΩ, e_n dominates and $e_{n,total} \approx e_n$.

The current noise of the AD8605 is so low that its total density does not become a significant term unless R_S is greater than 6 MΩ.

The total equivalent rms noise over a specific bandwidth is expressed as:

$$E_n = (e_{n,TOTAL})\sqrt{BW}$$

where BW is the bandwidth in Hertz.

NOTE: The above analysis is valid for frequencies larger than 100 Hz and assumes relatively flat noise, above 10 kHz. For lower frequencies, flicker noise (1/f) must be considered.

Channel Separation

Channel separation, or inversely crosstalk, is a measure of the signal feed from one amplifier (channel) to the other on the same IC.

The AD8606 has a channel separation of greater than -160 dB up to frequencies of 1 MHz, allowing the two amplifiers to amplify ac signals independently in most applications.

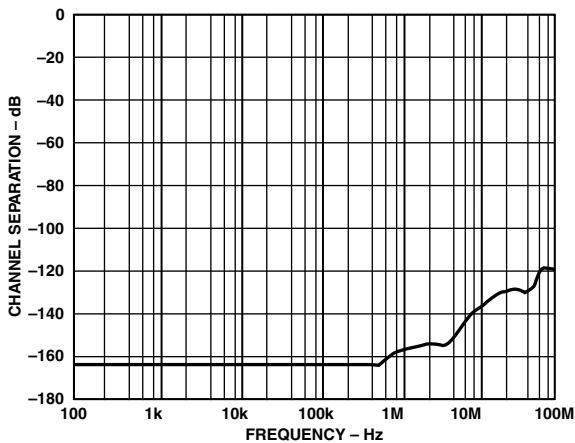

Figure 4. Channel Separation vs. Frequency

Capacitive Load Drive

The AD8605 is capable of driving large capacitive loads without oscillation.

Figure 5 shows the output of the AD8606 in response to a 200 mV input signal.

In this case, the amplifier was configured in positive unity gain, worst case for stability, while driving a 1,000 pF load at its output.

Driving larger capacitive loads in unity gain may require the use of additional circuitry.

A snubber network, shown in Figure 7, helps reduce the signal overshoot to a minimum and maintain stability. Although this circuit does not recover the loss of bandwidth induced by large capacitive loads, it greatly reduces the overshoot and ringing.

This method does not reduce the maximum output swing of the amplifier.

Figure 6 shows a scope photograph of the output at the snubber circuit.

The overshoot is reduced from over 70% to less than 5%, and the ringing is eliminated by the snubber.

Optimum values for R_S and C_S are determined experimentally. Table I summarizes a few starting values.

An alternate technique is to insert a series resistor inside the feedback loop at the output of the amplifier. Typically, the value of this resistor is approximately 100 Ω. This method also reduces overshoot and ringing but causes a reduction in the maximum output swing.

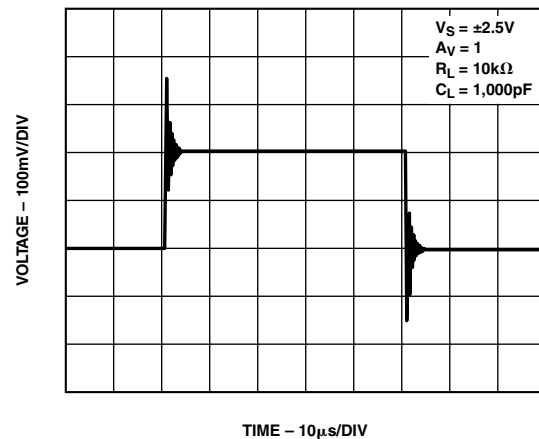

Figure 5. Capacitive Load Drive without Snubber

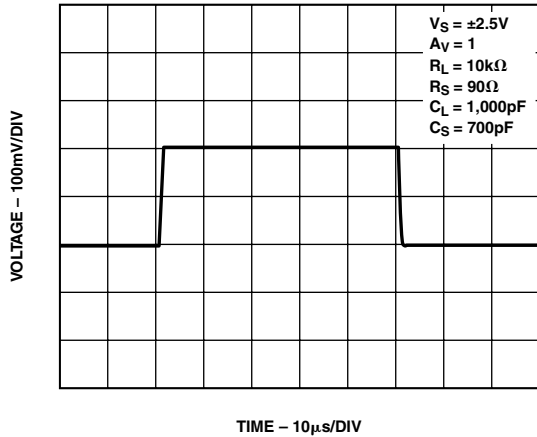

Figure 6. Capacitive Load Drive with Snubber

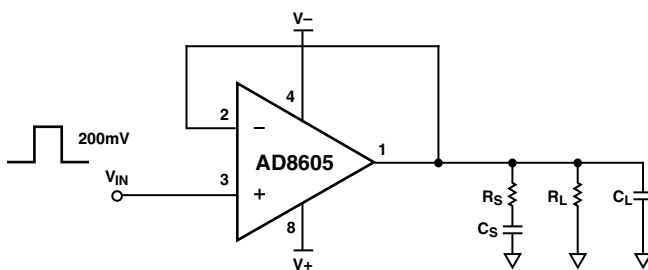

Figure 7. Snubber Network Configuration

Table I. Optimum Values for Capacitive Loads

C_L (pF)	R_S (Ω)	C_S (pF)
500	100	1,000
1,000	70	1,000
2,000	60	800

I-V CONVERSION APPLICATIONS

Photodiode Preamplifier Application

The low offset voltage and input current of the AD8605 make it an excellent choice for photodiode applications. In addition, the low voltage and current noise make the amplifier ideal for application circuits with high sensitivity.

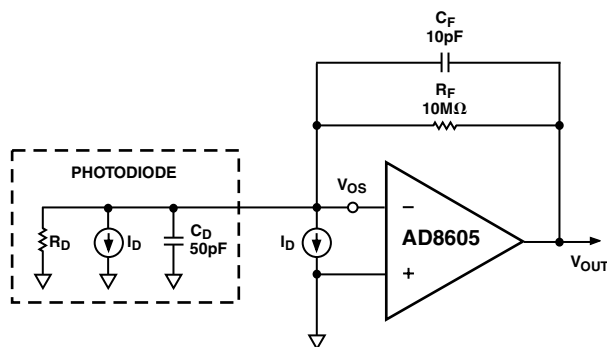

Figure 8. Equivalent Circuit for Photodiode Preamp

The input bias current of the amplifier contributes an error term that is proportional to the value of R_F .

The offset voltage causes a dark current induced by the shunt resistance of the diode, R_D . These error terms are combined at the output of the amplifier and the error voltage is written:

$$E_O = V_{OS} \left(\frac{1 + R_F}{R_D} \right) + R_F I_B$$

Typically, R_F is much smaller than R_D and R_D can be ignored.

At room temperature, the AD8605 has an input bias current of 0.2 pA and an offset voltage of 100 μ V. Typical values of R_D are in the range of 10 G Ω .

For the circuit shown in Figure 8, the output error voltage is approximately 100 μ V at room temperature, increasing to about 1 mV at 85°C.

The maximum achievable signal bandwidth is:

$$f_{MAX} = \sqrt{\frac{f_t}{2\pi R_F C_T}}$$

Where f_t is the unity gain frequency of the amplifier.

Audio and PDA Applications

The AD8605's low distortion and wide dynamic range make it a great choice for audio and PDA applications, including microphone amplification and line output buffering.

Figure 9 shows a typical application circuit for headphone/line out amplification.

R_1 and R_2 are used to bias the input voltage at half the supply. This maximizes the signal bandwidth range. C_1 and C_2 are used to ac-couple the input signal. C_1 and R_2 form a high-pass filter whose corner frequency is $1/2\pi R_1 C_1$.

The high output current of the AD8605 allows it to drive heavy resistive loads.

The circuit of Figure 9 was tested to drive a 16 Ω headphone. The THD + N is maintained at approximately -60 dB throughout the audio range.

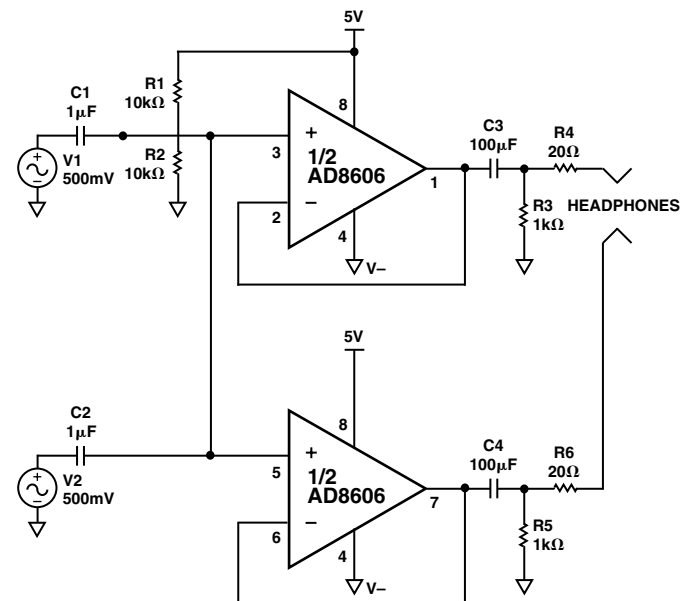

Figure 9. Single-Supply Headphone/Speaker Amplifier

AD8605/AD8606/AD8608

Instrumentation Amplifiers

The low offset voltage and low noise of the AD8605 make it a great amplifier for instrumentation applications.

Difference amplifiers are widely used in high accuracy circuits to improve the common-mode rejection ratio.

Figure 9 shows a simple difference amplifier. The CMRR of the circuit is plotted versus frequency. Figure 10 shows the common-mode rejection for a unity gain configuration and for a gain of 10.

Making $(R4/R3) = (R2/R1)$ and choosing 0.01% tolerance yields a CMRR of 74 dB and minimizes the gain error at the output.

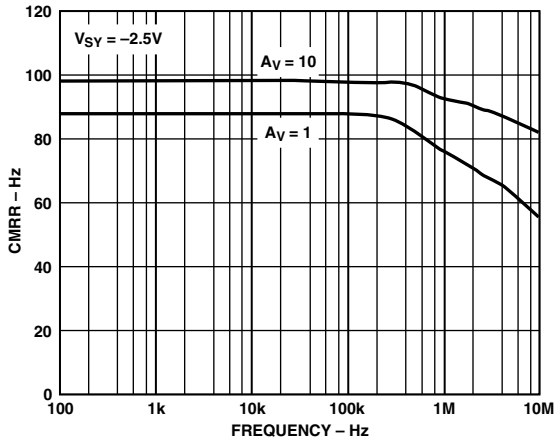

Figure 10. Difference Amplifier CMRR vs. Frequency

D/A Conversion

The low input bias current and offset voltage of the AD8605 make it an excellent choice for buffering the output of a current output DAC.

Figure 11 shows a typical implementation of the AD8605 at the output of a 12-bit DAC.

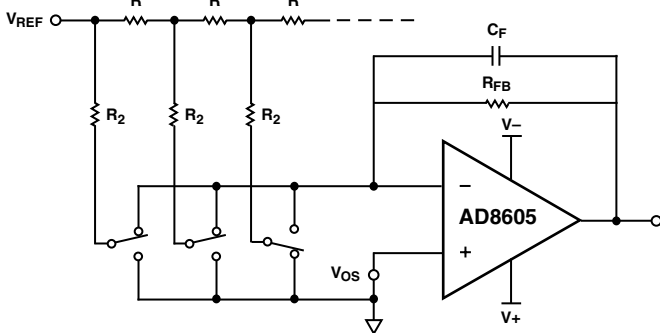

Figure 11. Simplified Circuit of the DAC 8143 with AD8605 Output Buffer

The DAC8143 output current is converted to a voltage by the feedback resistor. The equivalent resistance at the output of the DAC varies with the input code, as does the output capacitance.

To optimize the performance of the DAC, insert a capacitor in the feedback loop of the AD8605 to compensate the amplifier from the pole introduced by the output capacitance of the DAC. Typical values for C_F are in the range of 10 pF to 30 pF; it can be adjusted for the best frequency response. The total error at the output of the op amp can be computed by the formula:

$$E_O = V_{OS} \left(\frac{1 + R_F}{R_{eq}} \right)$$

where R_{eq} is the equivalent resistance seen at the output of the DAC. As mentioned above, R_{eq} is code dependant and varies with the input. A typical value for R_{eq} is 15 k Ω . Choosing a feedback resistor of 10 k Ω yields an error of less than 200 μ V.

Figure 12 shows the implementation of a dual-stage buffer at the output of a DAC.

The first stage is used as a buffer. Capacitor C1, with R_{eq} , creates a low-pass filter and thus provides phase lead to compensate for frequency response. The second stage of the AD8606 is used to provide voltage gain at the output of the buffer.

Grounding the positive input terminals in both stages reduces errors due to the common-mode output voltage. Choosing R1, R2, and R3 to match within 0.01% yields a CMRR of 74 dB and maintains minimum gain error in the circuit.

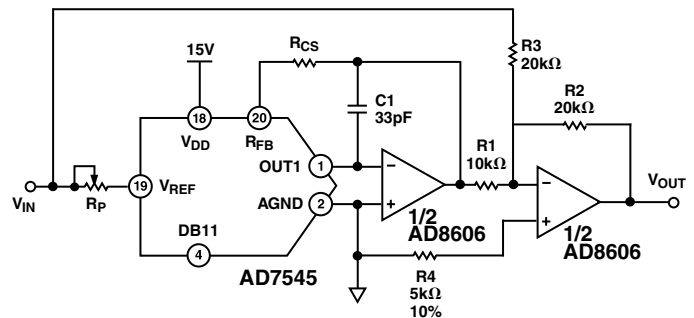
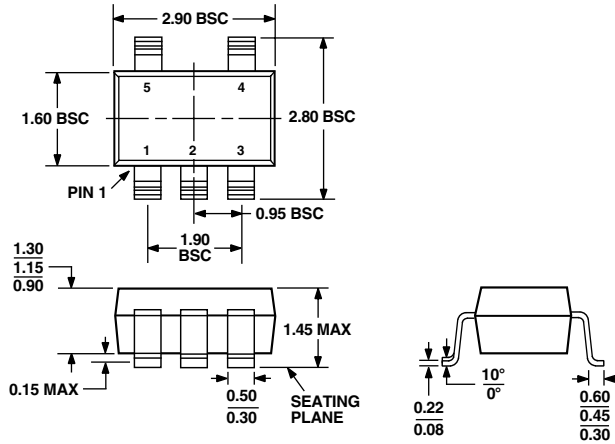

Figure 12. Bipolar Operation

OUTLINE DIMENSIONS

5-Lead Plastic Surface-Mount Package [SOT-23] (RT-5)

Dimensions shown in millimeters



COMPLIANT TO JEDEC STANDARDS MO-178AA

8-Lead Standard Small Outline Package [SOIC] Narrow Body (RN-8)

Dimensions shown in millimeters and (inches)

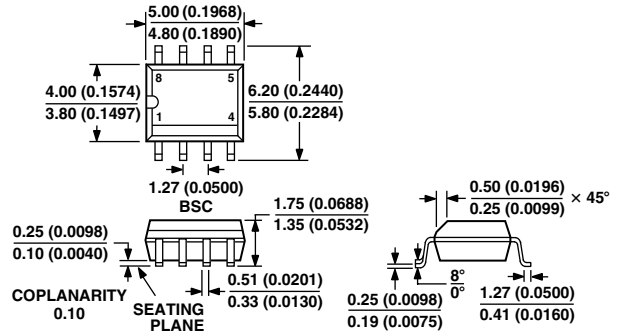

COMPLIANT TO JEDEC STANDARDS MS-012AA
CONTROLLING DIMENSIONS ARE IN MILLIMETERS; INCH DIMENSIONS (IN PARENTHESES) ARE ROUNDED-OFF MILLIMETER EQUIVALENTS FOR REFERENCE ONLY AND ARE NOT APPROPRIATE FOR USE IN DESIGN

8-Lead MSOP Package [MSOP] (RM-8)

Dimensions shown in millimeters

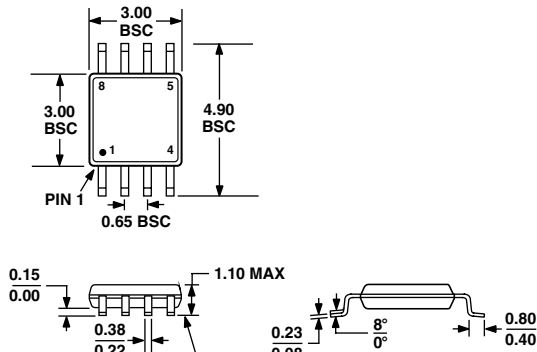

COMPLIANT TO JEDEC STANDARDS MO-187AA

14-Lead Standard Small Outline Package [SOIC] Narrow Body (RN-14)

Dimensions shown in millimeters and (inches)

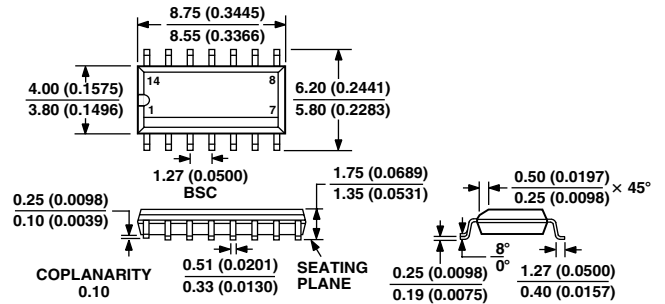

COMPLIANT TO JEDEC STANDARDS MS-012AB
CONTROLLING DIMENSIONS ARE IN MILLIMETERS; INCH DIMENSIONS (IN PARENTHESES) ARE ROUNDED-OFF MILLIMETER EQUIVALENTS FOR REFERENCE ONLY AND ARE NOT APPROPRIATE FOR USE IN DESIGN

14-Lead Thin Shrink Small Outline Package [TSSOP] (RU-14)

Dimensions shown in millimeters

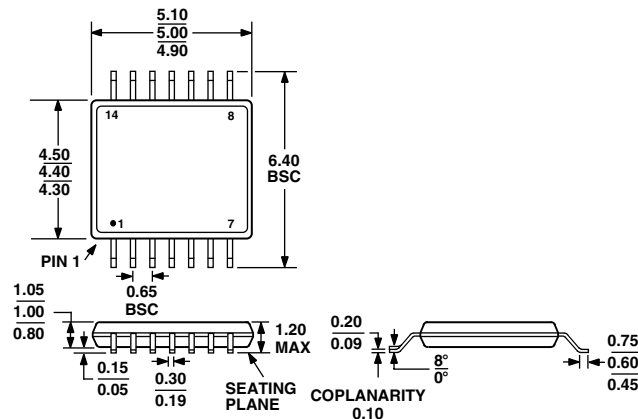

COMPLIANT TO JEDEC STANDARDS MO-153AB-1

AD8605/AD8606/AD8608

Revision History

Location	Page
11/02—Data Sheet changed from REV. 0 to REV. A.	
Change to ELECTRICAL CHARACTERISTICS	2
Update Absolute Maximum Ratings	4
Update Ordering Guide	4
Edit to TPC 6	5
Update OUTLINE DIMENSIONS	15

C02731-0-11/02(A)

PRINTED IN U.S.A.