

RoHS Compliant



1:1 Transmission Line Transformer
5-1200MHz

MABACT0060
V1P

Features

- Surface Mount
- 1:1 Impedance, with tertiary winding.
- Excellent amplitude and phase balance
- 260°C Reflow Compatible
- RoHS* Compliant
- Available on Tape and Reel. Reel quantity 2000

Description

M/A-COM's MABACT0060 is a 1:1 RF transmission line balun transformer in a low cost, surface mount package. The tertiary winding improves amplitude and phase balance. Ideally suited for high volume CATV/Broadband applications.

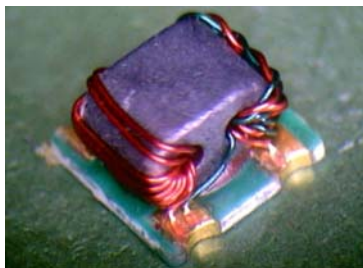

Schematic

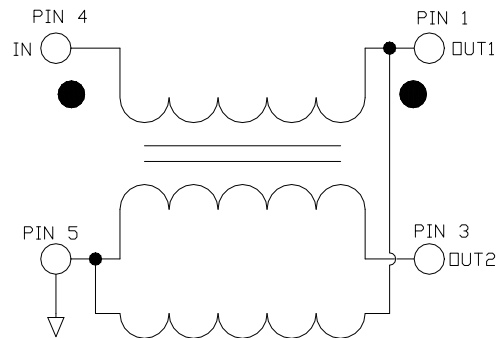

Case Style: SM-164

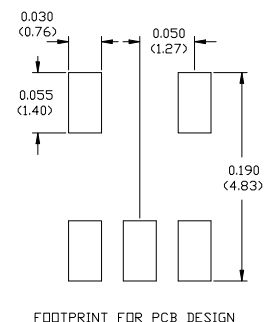
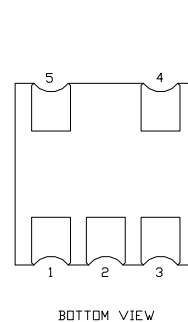
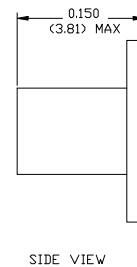
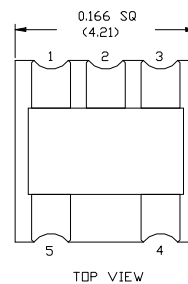

Dimensions in inches [mm] Tolerance: .xx ± .02, .xxx ± .010

Pin Configuration

Pin No.	Function
1	Secondary Dot (output 2)
2	Not Connected (ground)
3	Secondary (output 1)
4	Primary Dot (input)
5	Primary (ground)

Ordering Information

Part Number	Package
MABACT0060TR	2000 piece reel

Note: Reference Application Note **M513** for reel size information.

* Restrictions on Hazardous Substances, European Union Directive 2002/95/EC.

1

ADVANCED: Data Sheets contain information regarding a product M/A-COM Technology Solutions is considering for development. Performance is based on target specifications, simulated results, and/or prototype measurements. Commitment to develop is not guaranteed.

PRELIMINARY: Data Sheets contain information regarding a product M/A-COM Technology Solutions has under development. Performance is based on engineering tests. Specifications are typical. Mechanical outline has been fixed. Engineering samples and/or test data may be available. Commitment to produce in volume is not guaranteed.

• North America Tel: 800.366.2266 • Europe Tel: +353.21.244.6400
• India Tel: +91.80.4155721 • China Tel: +86.21.2407.1588

Visit www.macomtech.com for additional data sheets and product information.

M/A-COM Technology Solutions Inc. and its affiliates reserve the right to make changes to the product(s) or information contained herein without notice.

RoHS Compliant



1:1 Transmission Line Transformer
5-1200MHz

MABACT0060
V1P

Electrical Specifications: $T_A = 25^\circ\text{C}$, $Z_0 = 50\Omega$ ¹

Parameter	Test Conditions	Units	Min	Typ	Max
Insertion Loss	5 - 1000 MHz	dB	-	0.6	1.0
Insertion Loss	1000 - 1200 MHz	dB	-	0.8	1.1
Amplitude Unbalance (Nominal 0dB)	5 - 50 MHz	dB	-	0.35	± 0.8
Amplitude Unbalance (Nominal 0dB)	50 - 1200 MHz	dB	-	0.1	± 0.5
Phase Unbalance (Nominal 180°)	5 - 50 MHz	°	-	3	± 13.0
Phase Unbalance (Nominal 180°)	50 - 1000 MHz	°	-	2	± 4.5
Phase Unbalance (Nominal 180°)	1000 - 1200 MHz	°	-	3	± 10.0
Input Return Loss	5 - 50 MHz	dB	18	24	-
Input Return Loss	50 - 1200 MHz	dB	10	13	-

Absolute Maximum Ratings^{1,2}

Parameter	Absolute Maximum
Max Input Power	250mW
DC current	240mA
Operating Temperature	-40°C to +85°C
Storage Temperature	-55°C to +100°C

- Exceeding any one or combination of these limits may cause permanent damage to this device.
- M/A-COM does not recommend sustained operation near these survivability limits.

Recommended PCB Configuration

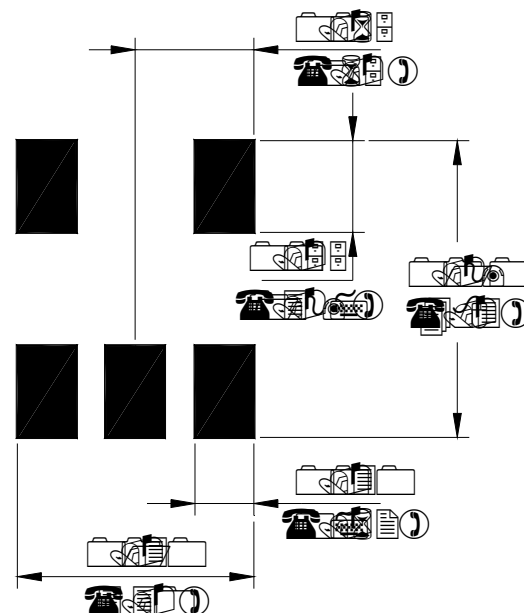

2

ADVANCED: Data Sheets contain information regarding a product M/A-COM Technology Solutions is considering for development. Performance is based on target specifications, simulated results, and/or prototype measurements. Commitment to develop is not guaranteed.

PRELIMINARY: Data Sheets contain information regarding a product M/A-COM Technology Solutions has under development. Performance is based on engineering tests. Specifications are typical. Mechanical outline has been fixed. Engineering samples and/or test data may be available. Commitment to produce in volume is not guaranteed.

• North America Tel: 800.366.2266 • Europe Tel: +353.21.244.6400
• India Tel: +91.80.4155721 • China Tel: +86.21.2407.1588

Visit www.macomtech.com for additional data sheets and product information.

M/A-COM Technology Solutions Inc. and its affiliates reserve the right to make changes to the product(s) or information contained herein without notice.

RoHS Compliant



1:1 Transmission Line Transformer
5-1200MHz

MABACT0060
V1P

Typical Performance Curves, $T_A = 25^\circ\text{C}$, $Z_0 = 50\Omega$

Insertion Loss 1 (through pin 4 to pin 3)

Insertion Loss 2 (coupled pin 4 to pin 1)

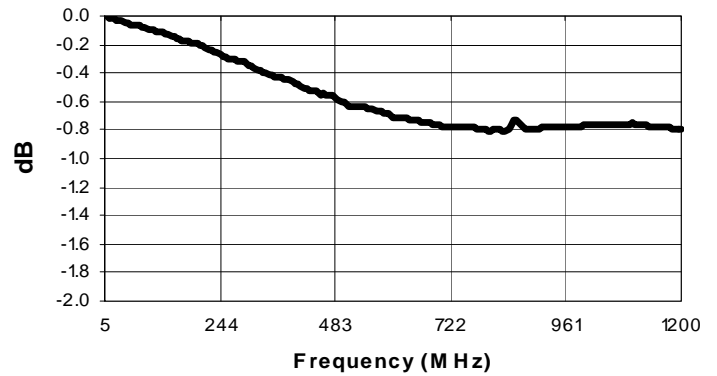
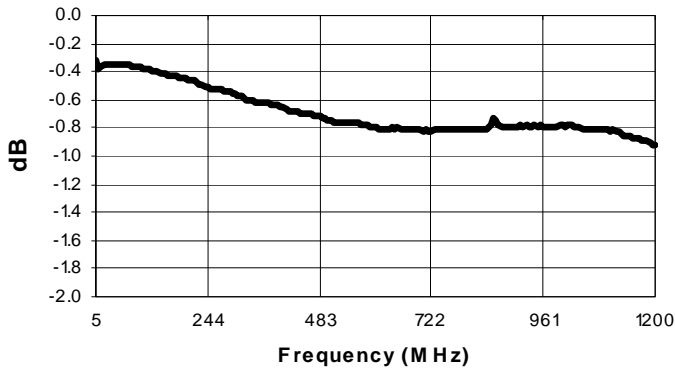

Amplitude Unbalance

Phase Balance

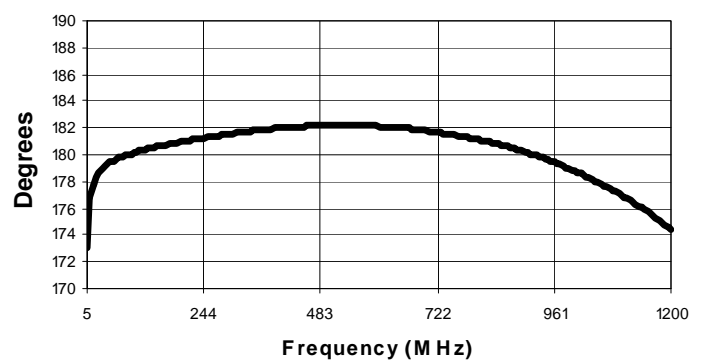
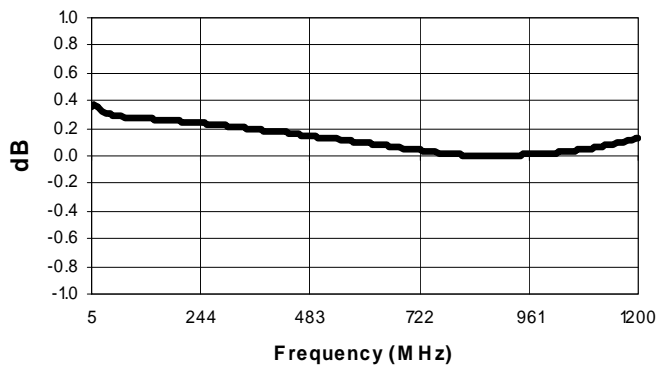

Input Return Loss

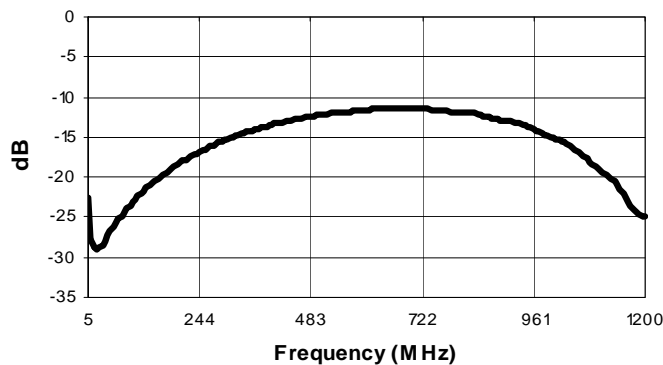

ADVANCED: Data Sheets contain information regarding a product M/A-COM Technology Solutions is considering for development. Performance is based on target specifications, simulated results, and/or prototype measurements. Commitment to develop is not guaranteed.

PRELIMINARY: Data Sheets contain information regarding a product M/A-COM Technology Solutions has under development. Performance is based on engineering tests. Specifications are typical. Mechanical outline has been fixed. Engineering samples and/or test data may be available. Commitment to produce in volume is not guaranteed.

• **North America** Tel: 800.366.2266 • **Europe** Tel: +353.21.244.6400
• **India** Tel: +91.80.4155721 • **China** Tel: +86.21.2407.1588

Visit www.macomtech.com for additional data sheets and product information.

M/A-COM Technology Solutions Inc. and its affiliates reserve the right to make changes to the product(s) or information contained herein without notice.