



P4VM800

User Manual

Version 1.0

Published April 2005

Copyright©2005 ASRock INC. All rights reserved.

---

### **Copyright Notice:**

No part of this manual may be reproduced, transcribed, transmitted, or translated in any language, in any form or by any means, except duplication of documentation by the purchaser for backup purpose, without written consent of ASRock Inc.

Products and corporate names appearing in this manual may or may not be registered trademarks or copyrights of their respective companies, and are used only for identification or explanation and to the owners' benefit, without intent to infringe.

### **Disclaimer:**

Specifications and information contained in this manual are furnished for informational use only and subject to change without notice, and should not be constructed as a commitment by ASRock. ASRock assumes no responsibility for any errors or omissions that may appear in this manual.

With respect to the contents of this manual, ASRock does not provide warranty of any kind, either expressed or implied, including but not limited to the implied warranties or conditions of merchantability or fitness for a particular purpose.

In no event shall ASRock, its directors, officers, employees, or agents be liable for any indirect, special, incidental, or consequential damages (including damages for loss of profits, loss of business, loss of data, interruption of business and the like), even if ASRock has been advised of the possibility of such damages arising from any defect or error in the manual or product.



This device complies with Part 15 of the FCC Rules. Operation is subject to the following two conditions:

- (1) this device may not cause harmful interference, and
- (2) this device must accept any interference received, including interference that may cause undesired operation.

**ASRock Website:** <http://www.asrock.com>

---

## Contents

<b>1. Introduction .....</b>	<b>5</b>
1.1 Package Contents .....	5
1.2 Specifications .....	6
1.3 Motherboard Layout .....	8
1.4 ASRock I/O Plus™ .....	9
<b>2. Installation .....</b>	<b>10</b>
Pre-installation Precautions .....	10
2.1 CPU Installation .....	11
2.2 Installation of CPU Fan and Heatsink .....	11
2.3 Installation of Memory Modules (DIMM) .....	12
2.4 Expansion Slots (PCI, AMR, and AGP Slots) .....	13
2.5 Jumpers Setup .....	14
2.6 Onboard Headers and Connectors .....	15
2.7 Serial ATA (SATA) Hard Disks Installation .....	18
2.8 Hot Plug and Hot Swap Functions for SATA HDDs .....	18
2.9 Installing Windows 2000 / Windows XP With RAID Functions .....	19
2.10 Installing Windows 98 / ME / 2000 / XP Without RAID Functions .....	20
<b>3. BIOS SETUP UTILITY .....</b>	<b>21</b>
3.1 Introduction .....	21
3.1.1 BIOS Menu Bar .....	21
3.1.2 Navigation Keys .....	22
3.2 Main Screen .....	22
3.3 Advanced Screen .....	22
3.3.1 CPU Configuration .....	23
3.3.2 Chipset Configuration .....	24
3.3.3 ACPI Configuration .....	26
3.3.4 IDE Configuration .....	27
3.3.5 PCIPnP Configuration .....	29
3.3.6 Floppy Configuration .....	29
3.3.7 Super IO Configuration .....	30
3.3.8 USB Configuration .....	31
3.4 Hardware Health Event Monitoring Screen .....	32
3.5 Boot Screen .....	32
3.5.1 Boot Settings Configuration .....	33
3.6 Security Screen .....	33
3.7 Exit Screen .....	34

---

<b>4. Software Support.....</b>	<b>35</b>
4.1 Install Operating System .....	35
4.2 Support CD Information .....	35
4.2.1 Running Support CD .....	35
4.2.2 Drivers Menu .....	35
4.2.3 Utilities Menu .....	35
4.2.4 Contact Information .....	35

---

## 1. Introduction

Thank you for purchasing ASRock P4VM800 motherboard, a reliable motherboard produced under ASRock's consistently stringent quality control. It delivers excellent performance with robust design conforming to ASRock's commitment to quality and endurance.

In this manual, chapter 1 and 2 contain introduction of the motherboard and step-by-step guide to the hardware installation. Chapter 3 and 4 contain the configuration guide to BIOS setup and information of the Support CD.



Because the motherboard specifications and the BIOS software might be updated, the content of this manual will be subject to change without notice. In case any modifications of this manual occur, the updated version will be available on ASRock website without further notice. You may find the latest memory and CPU support lists on ASRock website as well. ASRock website <http://www.asrock.com>

### 1.1 Package Contents

ASRock P4VM800 Motherboard

(Micro ATX Form Factor: 9.6-in x 8.0-in, 24.4 cm x 20.3 cm)

ASRock P4VM800 Quick Installation Guide

ASRock P4VM800 Support CD

One 80-conductor Ultra ATA 66/100/133 IDE Ribbon Cable

One Ribbon Cable for a 3.5-in Floppy Drive

One Serial ATA (SATA) Cable

One Serial ATA (SATA) HDD Power Cable(Optional)

One ASRock I/O Plus™ Shield

One COM Port Bracket

---

## 1.2 Specifications

<b>Platform:</b>	Micro ATX Form Factor: 9.6-in x 8.0-in, 24.4 cm x 20.3 cm
<b>CPU:</b>	Socket 478, supports Intel® Pentium® 4 / Celeron® (Prescott, Northwood, Willimatte) processor
<b>Chipsets:</b>	North Bridge: VIA P4M800 CE, FSB @ 800/533/400 MHz, with Intel® Hyper-Threading Technology ready (see <b>CAUTION 1</b> ) South Bridge: VIA VT8237R, supports USB 2.0, ATA 133, SATA 1.5Gb/s
<b>Memory:</b>	2 DDR DIMM Slots: DDR1 and DDR2 1 DDR DIMM Slot Supports PC3200 (DDR400), Max. 1GB, 2 DDR DIMM Slots Supports PC2700 (DDR333) / PC2100 (DDR266), Max. 2GB
<b>IDE:</b>	IDE1: ATA 133 / Ultra DMA Mode 6 IDE2: ATA 133 / Ultra DMA Mode 6 Supports up to 4 IDE devices
<b>Serial ATA:</b>	2 SATA connectors Support up to 1.5Gb/s data transfer rate
<b>Floppy Port:</b>	Supports up to 2 floppy disk drives
<b>Audio:</b>	5.1 channels AC'97 Audio
<b>OnBoard VGA:</b>	S3 Unichrome Pro 3D/2D Graphics Controller, supports DX7 H / W
<b>LAN:</b>	Speed: 802.3u (10/100 Ethernet), supports Wake-On-LAN
<b>Hardware Monitor:</b>	CPU temperature sensing Chassis temperature sensing CPU overheat shutdown to protect CPU life (ASRock U-COP)(see <b>CAUTION 2</b> ) CPU fan tachometer Chassis fan tachometer Voltage monitoring: +12V, +5V, +3.3V, Vcore
<b>PCI slots:</b>	3 slots with PCI Specification 2.2, PCI3 slot shared with AMR
<b>AGP slot:</b>	1 AGP slot, supports 1.5V, 8X/4X AGP card (see <b>CAUTION 3</b> )
<b>AMR slot:</b>	1 slot, supports ASRock MR card
<b>USB 2.0:</b>	8 USB 2.0 ports: include 6 ready-to-use USB 2.0 ports on the rear panel, plus two on-board headers supporting 2 extra USB 2.0 ports (see <b>CAUTION 4</b> )

---

**ASRock I/O Plus™:** 1 PS/2 mouse port, 1 PS/2 keyboard port,  
1 VGA port,  
1 parallel port: ECP/EPP support,  
6 ready-to-use USB 2.0 ports,  
1 RJ 45 port,  
Audio Jack: Line In / Line Out / Microphone

**BIOS:** AMI BIOS  
Supports "Plug and Play"  
ACPI 1.1 compliance wake up events  
Supports jumperfree  
SMBIOS 2.3.1 support  
CPU frequency stepless control  
(only for advanced users' reference, see **CAUTION 5**)

**OS:** Microsoft® Windows® 98SE / ME / 2000 / XP compliant

### **CAUTION!**

1. About the setting of "Hyper Threading Technology", please check page 24.
2. While CPU overheat is detected, the system will automatically shutdown. Before you resume the system, please check if the CPU fan on the motherboard functions properly and unplug the power cord, then plug it back again. To improve heat dissipation, remember to spray thermal grease between the CPU and the heatsink when you install the PC system.
3. Do NOT use a 3.3V AGP card on the AGP slot of this motherboard!  
It may cause permanent damage!
4. Power Management for USB 2.0 works fine under Microsoft® Windows® XP SP1 / 2000 SP4. It may not work properly under Microsoft® Windows® 98 / ME.
5. Although this motherboard offers stepless control, it is not recommended to perform over-clocking. Frequencies other than the recommended CPU bus frequencies may cause the instability of the system or damage the CPU.

### 1.3 Motherboard Layout

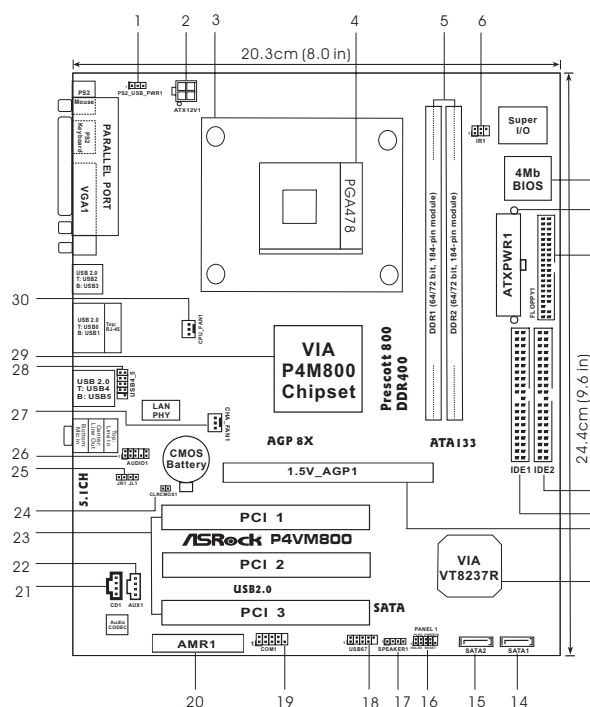

- |   |   |
|---|---|
| 1 PS2_USB_PWR1 Jumper                           | 16 System Panel Header (PANEL1)           |
| 2 ATX 12V Connector (ATX12V1)                   | 17 Chassis Speaker Header (SPEAKER 1)     |
| 3 CPU Heatsink Retention Module                 | 18 USB 2.0 Header (USB67, Blue)           |
| 4 CPU Socket                                    | 19 Serial Port Connector (COM1)           |
| 5 2 x 184-pin DDR DIMM Slots (DDR1, DDR2; Blue) | 20 AMR Slot (AMR1)                        |
| 6 Infrared Module Header (IR1)                  | 21 Internal Audio Connector: CD1 (Black)  |
| 7 Flash Memory                                  | 22 Internal Audio Connector: AUX1 (White) |
| 8 ATX Power Connector (ATXPWR1)                 | 23 3 x PCI Slots (PCI1-3)                 |
| 9 Floppy Connector (FLOPPY1)                    | 24 Clear CMOS Jumper (CLRCMOS1)           |
| 10 Secondary IDE Connector (IDE2, Black)        | 25 JR1/JL1 Jumpers                        |
| 11 Primary IDE Connector (IDE1, Blue)           | 26 Front Panel Audio Header (AUDIO1)      |
| 12 AGP Slot (1.5V_AGP1)                         | 27 Chassis Fan Connector (CHA_FAN1)       |
| 13 South Bridge Controller                      | 28 Shared USB 2.0 Header (USB4_5, Blue)   |
| 14 Primary Serial ATA Connector (SATA1)         | 29 North Bridge Controller                |
| 15 Secondary Serial ATA Connector (SATA2)       | 30 CPU Fan Connector (CPU_FAN1)           |



---

## 1.4 ASRock I/O Plus™

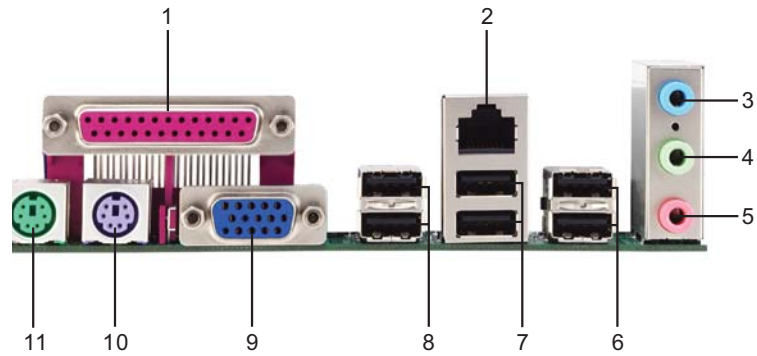

- |   |                              |    |                             |
|---|------------------------------|----|-----------------------------|
| 1 | Parallel Port                | 7  | USB 2.0 Ports (USB01)       |
| 2 | RJ-45 Port                   | 8  | USB 2.0 Ports (USB23)       |
| 3 | Line In (Light Blue)         | 9  | VGA Port                    |
| 4 | Line Out (Lime)              | 10 | PS/2 Keyboard Port (Purple) |
| 5 | Microphone (Pink)            | 11 | PS/2 Mouse Port (Green)     |
| 6 | Shared USB 2.0 Ports (USB45) |    |                             |

---

## 2. Installation

P4VM800 is a Micro ATX form factor (9.6-in x 8.0-in, 24.4 cm x 20.3 cm) motherboard. Before you install the motherboard, study the configuration of your chassis to ensure that the motherboard fits into it.

### Pre-installation Precautions

Take note of the following precautions before you install motherboard components or change any motherboard settings.

1. Unplug the power cord from the wall socket before touching any component.
2. To avoid damaging the motherboard components due to static electricity, NEVER place your motherboard directly on the carpet or the like. Also remember to use a grounded wrist strap or touch a safety grounded object before you handle components.
3. Hold components by the edges and do not touch the ICs.
4. Whenever you uninstall any component, place it on a grounded anti-static pad or in the bag that comes with the component.



Before you install or remove any component, ensure that the power is switched off or the power cord is detached from the power supply. Failure to do so may cause severe damage to the motherboard, peripherals, and/or components.

---

## 2.1 CPU Installation

- Step 1. Unlock the socket by lifting the lever up to a 90° angle.
- Step 2. Position the CPU directly above the socket such that its marked corner matches the base of the socket lever.
- Step 3. Carefully insert the CPU into the socket until it fits in place.



The CPU fits only in one correct orientation. DO NOT force the CPU into the socket to avoid bending of the pins.

- Step 4. When the CPU is in place, press it firmly on the socket while you push down the socket lever to secure the CPU. The lever clicks on the side tab to indicate that it is locked.



STEP 1:  
Lift The Socket Lever Up to 90°

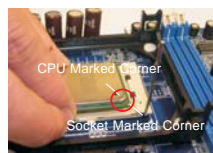

STEP 2/STEP 3:  
Match The CPU Marked Corner  
to The Socket Marked Corner



STEP 4:  
Push Down And Lock  
The Socket Lever

## 2.2 Installation of CPU Fan and Heatsink

This motherboard adopts 478-pin CPU socket to support Intel® Pentium® 4/ Celeron® CPU. It requires larger heatsink and cooling fan to dissipate heat. You also need to spray thermal grease between the CPU and the heatsink to improve heat dissipation. Make sure that the CPU and the heatsink are securely fastened and in good contact with each other. Then connect the CPU fan to the CPU\_FAN connector (CPU\_FAN1, see p.8 No. 30). For proper installation, please kindly refer to the instruction manuals of the CPU fan and the heatsink.

---

## 2.3 Installation of Memory Modules (DIMM)

P4VM800 motherboard provides two 184-pin DDR (Double Data Rate) DIMM slots.



Please make sure to disconnect power supply before adding or removing DIMMs or the system components.

- Step 1. Unlock a DIMM slot by pressing the retaining clips outward.  
Step 2. Align a DIMM on the slot such that the notch on the DIMM matches the break on the slot.

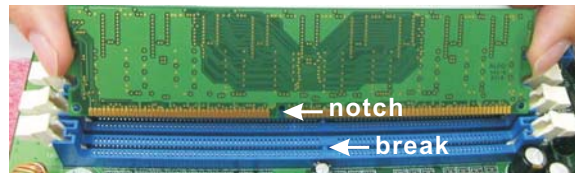
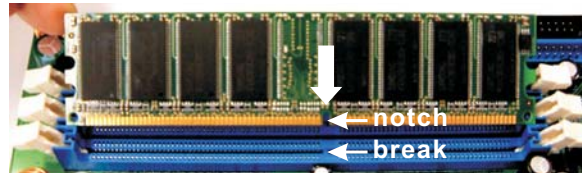

The DIMM only fits in one correct orientation. It will cause permanent damage to the motherboard and the DIMM if you force the DIMM into the slot at incorrect orientation.

- Step 3. Firmly insert the DIMM into the slot until the retaining clips at both ends fully snap back in place and the DIMM is properly seated.

---

## 2.4 Expansion Slots (PCI, AMR and AGP Slots)

There are 3 PCI slots, 1 AMR slot, and 1 AGP slot on P4VM800 motherboard.

**PCI slots:** PCI slots are used to install expansion cards that have the 32-bit PCI interface.

**AMR slot:** The AMR slot is used to insert an ASRock MR card with v.92 Modem functionality.

**AGP slot:** The AGP slot is used to install a graphics card. The ASRock AGP slot has a special design of clasp that can securely fasten the inserted graphics card.



Please do NOT use a 3.3V AGP card on the AGP slot of this motherboard! It may cause permanent damage! For the voltage information of your AGP card, please check with the AGP card vendors.

### Installing an expansion card

- Step 1. Before installing the expansion card, please make sure that the power supply is switched off or the power cord is unplugged. Please read the documentation of the expansion card and make necessary hardware settings for the card before you start the installation.
- Step 2. Remove the system unit cover (if your motherboard is already installed in a chassis).
- Step 3. Remove the bracket facing the slot that you intend to use. Keep the screws for later use.
- Step 4. Align the card connector with the slot and press firmly until the card is completely seated on the slot.
- Step 5. Fasten the card to the chassis with screws.
- Step 6. Replace the system cover.

## 2.5 Jumpers Setup

The illustration shows how jumpers are setup. When the jumper cap is placed on pins, the jumper is "Short". If no jumper cap is placed on pins, the jumper is "Open". The illustration shows a 3-pin jumper whose pin1 and pin2 are "Short" when jumper cap is placed on these 2 pins.

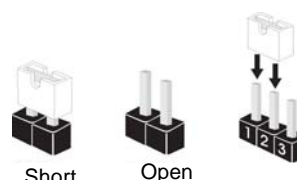

Jumper	Setting	
PS2_USB_PWR1 (see p.8, No. 1)	<div style="display: flex; justify-content: space-around;"> <div style="text-align: center;"> <p>1_2</p> <p>+5V</p> </div> <div style="text-align: center;"> <p>2_3</p> <p>+5VSB</p> </div> </div>	Short pin2, pin3 to enable +5VSB (standby) for PS/2 or USB wake up events.

Note: To select +5VSB, it requires 2 Amp and higher standby current provided by power supply.

JR1 (see p.8, No. 25)	
JL1 (see p.8, No. 25)	

Note: If the jumpers JL1 and JR1 are short, both the front panel and the rear panel audio connectors can work.

Clear CMOS (CLRCMOS1, 2-pin jumper) (see p.8, No. 24)	<p>2-pin jumper</p>
---	---------------------

Note: CLRCMOS1 allows you to clear the data in CMOS. The data in CMOS includes system setup information such as system password, date, time, and system setup parameters. To clear and reset the system parameters to default setup, please turn off the computer and unplug the power cord from the power supply. After waiting for 15 seconds, use a jumper cap to short 2 pins on CLRCMOS1 for 5 seconds. However, please do not clear the CMOS right after you update the BIOS. If you need to clear the CMOS when you just finish updating the BIOS, you must boot up the system first, and then shut it down before you do the clear-CMOS action.

## 2.6 Onboard Headers and Connectors



Onboard headers and connectors are NOT jumpers. Do NOT place jumper caps over these headers and connectors. Placing jumper caps over the headers and connectors will cause permanent damage of the motherboard!

FDD Connector  
(33-pin FLOPPY1)  
(see p.8, No. 9)



Note: Make sure the red-striped side of the cable is plugged into Pin1 side of the connector.

Primary IDE Connector (Blue)  
(39-pin IDE1, see p.8, No. 11)

Secondary IDE Connector (Black)  
(39-pin IDE2, see p.8, No. 10)



connect the blue end  
to the motherboard



connect the black end  
to the IDE devices

80-conductor ATA 66/100/133 cable

Note: If you use only one IDE device on this motherboard, please set the IDE device as "Master". Please refer to the instruction of your IDE device vendor for the details. Besides, to optimize compatibility and performance, please connect your hard disk drive to the primary IDE connector (IDE1, blue) and CD-ROM to the secondary IDE connector (IDE2, black).

Serial ATA Connectors  
(SATA1: see p.8, No. 14)  
(SATA2: see p.8, No. 15)



These two Serial ATA (SATA) connectors support SATA data cables for internal storage devices. The current SATA interface allows up to 1.5 Gb/s data transfer rate.

Serial ATA (SATA)  
Data Cable



Either end of the SATA data cable can be connected to the SATA hard disk or the SATA connector on the motherboard.

**Serial ATA (SATA)  
Power Cable**

(Optional)

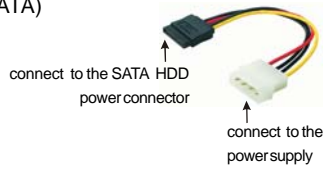

Please connect the black end of SATA power cable to the power connector on the drive. Then connect the white end of SATA power cable to the power connector of the power supply.

**USB 2.0 Header**

(9-pin USB67)

(see p.8, No. 18)

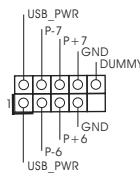

ASRock I/O Plus™ provides you 6 ready-to-use USB 2.0 ports on the rear panel. If the rear USB ports are not sufficient, this USB 2.0 header is available to support 2 extra USB 2.0 ports.

**Shared USB 2.0 Header**

(9-pin USB4\_5)

(see p.8, No. 28)

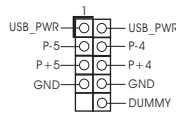

This USB4\_5 connector is shared with the USB 2.0 ports 4,5 on ASRock I/O Plus™. When using the front panel USB ports by attaching the front panel USB cable to this connector (USB4\_5), the USB ports 4,5 on ASRock I/O Plus™ will not be able to function.

**Infrared Module Header**

(5-pin IR1)

(see p.8, No. 6)

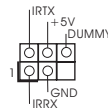

This header supports an optional wireless transmitting and receiving infrared module.

**Internal Audio Connectors**

(4-pin CD1, 4-pin AUX1)

(CD1: see p.8, No. 21)

(AUX1: see p.8, No. 22)

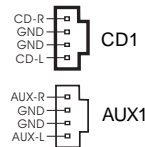

These connectors allow you to receive stereo audio input from sound sources such as a CD-ROM, DVD-ROM, TV tuner card, or MPEG card.

**Front Panel Audio Header**

(9-pin AUDIO1)

(see p.8, No. 26)

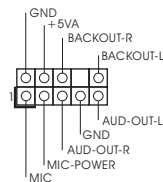

This is an interface for the front panel audio cable that allows convenient connection and control of audio devices.



**System Panel Header**

(9-pin PANEL1)  
(see p.8, No. 16)

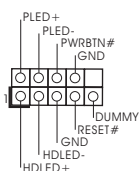

This header accommodates several system front panel functions.

**Chassis Speaker Header**

(4-pin SPEAKER 1)  
(see p.8, No. 17)

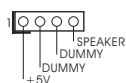

Please connect the chassis speaker to this header.

**Chassis Fan Connector**

(3-pin CHA\_FAN1)  
(see p.8, No. 27)



Please connect the chassis fan cable to this connector and match the black wire to the ground pin.

**CPU Fan Connector**

(3-pin CPU\_FAN1)  
(see p.8, No. 30)



Please connect the CPU fan cable to this connector and match the black wire to the ground pin.

**ATX Power Connector**

(20-pin ATXPWR1)  
(see p.8, No. 8)



Please connect an ATX power supply to this connector.

**ATX 12V Connector**

(4-pin ATX12V1)  
(see p.8, No. 2)



Please note that it is necessary to connect a power supply with ATX 12V plug to this connector so that it can provides sufficient power. Failing to do so will cause the failure to power up.



Please install the heatsink and the CPU fan before installing ATX 12V connector; otherwise, it may cause permanent damage!

**Serial port connector**

(9-pin COM1)  
(see p.8 item 19)

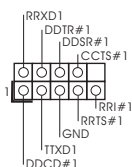

This COM1 connector supports a serial port module.

---

## 2.7 Serial ATA (SATA) Hard Disks Installation

This motherboard adopts VIA VT8237R southbridge chipset that supports Serial ATA (SATA) hard disks and RAID functions. You may install SATA hard disks on this motherboard for internal storage devices. This section will guide you to install the SATA hard disks.

- STEP 1: Install the SATA hard disks into the drive bays of your chassis.
- STEP 2: Connect the SATA power cable to the SATA hard disk.
- STEP 3: Connect one end of the SATA data cable to the motherboard's SATA connector.
- STEP 4: Connect the other end of the SATA data cable to the SATA hard disk.

## 2.8 Hot Plug and Hot Swap Functions for SATA HDDs

P4VM800 motherboard supports Hot Plug and Hot Swap functions for SATA Devices.



### NOTE

#### What is Hot Plug Function?

If the SATA HDDs are NOT set for RAID configuration, it is called "Hot Plug" for the action to insert and remove the SATA HDDs while the system is still power-on and in working condition.

However, please note that it cannot perform Hot Plug if the OS has been installed into the SATA HDD.

#### What is Hot Swap Function?

If SATA HDDs are built as RAID1 then it is called "Hot Swap" for the action to insert and remove the SATA HDDs while the system is still power-on and in working condition.

---

## 2.9 Installing Windows 2000 / Windows XP With RAID Functions

If you want to install Windows 2000 / Windows XP OS on your SATA HDDs with RAID functions, please follow the below steps.

### STEP 1: Make a SATA Driver Diskette.

- A. Insert the ASRock Support CD into your optical drive to boot your system.
- B. During POST at the beginning of system boot-up, press <F11> key, and then a window for boot devices selection appears. Please select CD-ROM as the boot device.
- C. When you see the message on the screen, "Do you want to generate Serial ATA driver diskette [YN]?", press <Y>.
- D. Then you will see these messages,

**Please insert a diskette into the floppy drive.**

**WARNING! Formatting the floppy diskette will lose ALL data in it!**

**Start to format and copy files [YN]?**

Please insert a floppy diskette into the floppy drive, and press <Y>.

- E. The system will start to format the floppy diskette and copy SATA drivers into the floppy diskette.

### STEP 2: Use "SATA RAID BIOS" to set RAID configuration.

Before you start to configure the RAID function, you need to check the installation guide in the Support CD for proper configuration. Please refer to the document in the Support CD, "Guide to SATA Hard Disks Installation and RAID Configuration", which is located in the folder at the following path: .. \ **SATA RAID BIOS**

### STEP 3: Install Windows 2000 / Windows XP OS on your system.

After making a SATA driver diskette and using "SATA RAID BIOS" to set RAID configuration, you can start to install Windows 2000 / Windows XP on your system.

After the installation of Windows 2000 / Windows XP OS, if you want to manage RAID functions, you are allowed to use both "SATA RAID BIOS" and "VIA RAID Tool" for RAID configuration. Please refer to the document in the Support CD, "Guide to SATA Hard Disks Installation and RAID Configuration", which is located in the folder at the following path: .. \ **SATA RAID BIOS** and the document in the support CD, "Guide to VIA RAID Tool", which is located in the folder at the following path: .. \ **VIA RAID Tool**



1. Windows 98 / Windows ME does not support RAID functions.
2. If you want to use "VIA RAID Tool" in Windows environment, please install SATA drivers from the Support CD again so that "VIA RAID Tool" will be installed to your system as well.

---

## 2.10 Installing Windows 98 / ME / 2000 / XP Without RAID Functions

If you want to install Windows 98 / ME / 2000 / XP on your SATA HDDs without RAID functions or you want to install Windows 98 / ME / 2000 / XP on your IDE HDDs instead of SATA HDDs, please follow the below steps.



If you want to install Windows 98 / Windows ME on your SATA HDDs without RAID functions, you don't have to set up BIOS. Please install Windows 98 / Windows ME OS on your system directly.

### STEP 1: Set Up BIOS. (For Windows 2000 / XP / XP 64-bit.)

- A. Enter BIOS SETUP UTILITY ; -Advanced screen ; -IDE Configuration.
- B. Set the "SATA Operation Mode" option from [RAID] to [non-RAID].

### STEP 2: Install Windows 98 / ME / 2000 / XP OS on your system.

After setting up BIOS, you can start to install Windows 98 / ME / 2000 / XP on your system.



If you don't want to set up RAID functions, there is no need to make a SATA driver diskette.

---

## 3. BIOS SETUP UTILITY

### 3.1 Introduction

This section explains how to use the BIOS SETUP UTILITY to configure your system. The Flash Memory on the motherboard stores the BIOS SETUP UTILITY. You may run the BIOS SETUP UTILITY when you start up the computer. Please press <F2> during the Power-On-Self-Test (POST) to enter the BIOS SETUP UTILITY, otherwise, POST will continue with its test routines.

If you wish to enter the BIOS SETUP UTILITY after POST, restart the system by pressing <Ctl> + <Alt> + <Delete>, or by pressing the reset button on the system chassis. You may also restart by turning the system off and then back on.



Because the BIOS software is constantly being updated, the following BIOS setup screens and descriptions are for reference purpose only, and they may not exactly match what you see on your screen.

#### 3.1.1 BIOS Menu Bar

The top of the screen has a menu bar with the following selections:

- Main** To set up the system time/date information
- Advanced** To set up the advanced BIOS features
- H/W Monitor** To display current hardware status
- Boot** To set up the default system device to locate and load the Operating System
- Security** To set up the security features
- Exit** To exit the current screen or the BIOS SETUP UTILITY

Use <←> key or <→> key to choose among the selections on the menu bar, and then press <Enter> to get into the sub screen.

### 3.1.2 Navigation Keys

Please check the following table for the function description of each navigation key.

Navigation Key(s)	Function Description
← / →	Moves cursor left or right to select Screens
↑ / ↓	Moves cursor up or down to select items
+ / -	To change option for the selected items
<Enter>	To bring up the selected screen
<F1>	To display the General Help Screen
<F9>	To load optimal default values for all the settings
<F10>	To save changes and exit the BIOS SETUP UTILITY
<ESC>	To jump to the Exit Screen or exit the current screen

### 3.2 Main Screen

When you enter the BIOS SETUP UTILITY, the Main screen will appear and display the system overview

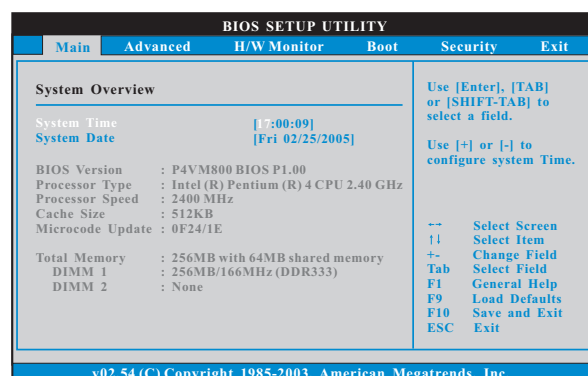

#### System Time [Hour:Minute:Second]

Use this item to specify the system time.

#### System Date [Day Month/Date/Year]

Use this item to specify the system date.

### 3.3 Advanced Screen

In this section, you may set the configurations for the following items: CPU Configuration, Chipset Configuration, ACPI Configuration, IDE Configuration, PCIPnP Configuration, Floppy Configuration, SuperIO Configuration, and USB Configuration.

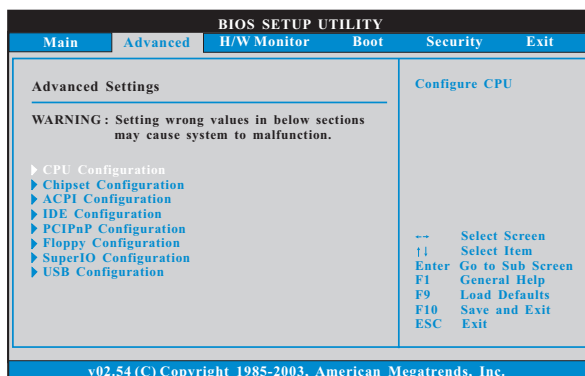

Setting wrong values in this section may cause the system to malfunction.

### 3.3.1 CPU Configuration

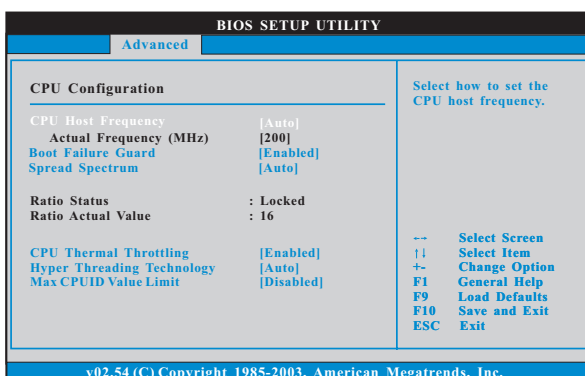

#### CPU Host Frequency

While entering setup, BIOS auto detects the present CPU host frequency of this motherboard. The actual CPU host frequency will show in the following item.

#### Boot Failure Guard

Enable or disable the feature of Boot Failure Guard.

#### Spread Spectrum

Select [Auto] for the spread spectrum feature.

#### Ratio Status

This is a read-only item, which displays whether the ratio status of this motherboard is "Locked" or "Unlocked". If it shows "Unlocked", you will find an item **Ratio CMOS Setting** appears to allow you changing the ratio value of this motherboard. If it shows "Locked", then the item **Ratio CMOS**

**Setting** will be hidden. If you use the ratio value to time the CPU frequency, it will be equal to the core speed of the installed processor.

#### Ratio Actual Value

This is a read-only item, which displays the ratio actual value of this motherboard.

#### CPU Thermal Throttling

You may select [Enabled] to enable P4 CPU internal thermal control mechanism to keep the CPU from overheated.

#### Hyper Threading Technology

To enable this feature, it requires a computer system with an Intel Pentium®4 processor that supports Hyper-Threading technology and an operating system that includes optimization for this technology, such as Microsoft® Windows® XP. Set to [Auto] if using Microsoft® Windows® XP, or Linux kernel version 2.4.18 or higher. This option will be hidden if the installed CPU does not support Hyper-Threading technology.

#### Max CPUID Value Limit

For Prescott CPU only, some OSes (ex. NT4.0) cannot handle the function with disable. This should be enabled in order to boot legacy OSes that cannot support CPUs with extended CPUID functions.

### 3.3.2 Chipset Configuration

BIOS SETUP UTILITY		
Advanced		
<b>Chipset Configuration</b>		
DRAM Frequency	[Auto]	
Flexibility Option	[Disabled]	
DRAM CAS# Latency	[Auto]	
DRAM Command Rate	[2T Command]	
DRAM Voltage	[Auto]	
AGP Voltage	[Auto]	
Primary Graphics Adapter	[PCI]	
AGP Aperture Size	[64MB]	
AGP Mode	[Auto]	
AGP Fast Write	[Disabled]	
Onboard AGP Share Memory	[Auto]	
PCI Delay Transaction	[Disabled]	
OnBoard LAN	[Enabled]	
OnBoard AC'97 Audio	[Auto]	
Onboard MC'97 Modem	[Auto]	
		<b>Options</b>
		133MHz (DDR266)
		166MHz (DDR333)
		200MHz (DDR400)
		Auto
		-- Select Screen
		F1 Select Item
		+/- Change Option
		F1 General Help
		F9 Load Defaults
		F10 Save and Exit
		ESC Exit
v02.54 (C) Copyright 1985-2003, American Megatrends, Inc.		

#### DRAM Frequency

If [Auto] is selected, the motherboard will detect the memory module(s) inserted and assigns appropriate frequency automatically. You may also select other value as operating frequency: [133MHz (DDR 266)], [166MHz (DDR 333)], [200MHz (DDR 400)].

#### Flexibility Option

The default value of this option is [Disabled]. It will allow better tolerance for memory compatibility when it is set to [Enabled].



---

**DRAM CAS# Latency**

Use this item to adjust the means of memory accessing. Configuration options: [Auto], [2.5], [2], and [3].

**DRAM Command Rate**

The default value of this feature is set to [Auto].

**DRAM Voltage**

The default value of this feature is set to [Auto].

**AGP Voltage**

Use this to select among [Normal] and [High] for AGP Voltage. The default value is [High].

**Primary Graphics Adapter**

This allows you to select [PCI] or [AGP] as the primary graphics adapter. The default value is [PCI].

**AGP Aperture Size**

It refers to a section of the PCI memory address range used for graphics memory. It is recommended to leave this field at the default value unless the installed AGP card's specifications requires other sizes.

**AGP Mode**

The default value of this feature is set to [Auto]. If you install an 8X-AGP card on this motherboard, you may select [Auto], [8X] or [4X] as the AGP mode. If the installed AGP card is a 4X-AGP card, then you may set the AGP mode as [Auto], [4X], [2X], or [1X].

**AGP Fast Write**

This allows you to enable or disable the feature of AGP fast write protocol support.

**Onboard AGP Share Memory**

You may select [Auto], [8MB], [16MB], [32MB], or [64MB] as the Onboard AGP share Memory. The default value of this feature is set to [Auto]. When the total memory is equal or above 256MB, the share memory size will be [64MB]; otherwise, please set the share memory size to [32MB].

**PCI Delay Transaction**

Enable PCI Delay Transaction feature will free the PCI Bus when the CPU is accessing 8-bit ISA cards. Disable this feature when using ISA cards that are not PCI 2.1 compliant.

**OnBoard LAN**

This allows you to enable or disable the onboard LAN feature.

**OnBoard AC'97 Audio**

Select [Auto], [Enabled], or [Disabled] for the onboard AC'97 Audio feature.

**OnBoard MC'97 Modem**

Select [Auto] or [Disabled] for the onboard MC'97 Modem feature.

### 3.3.3 ACPI Configuration

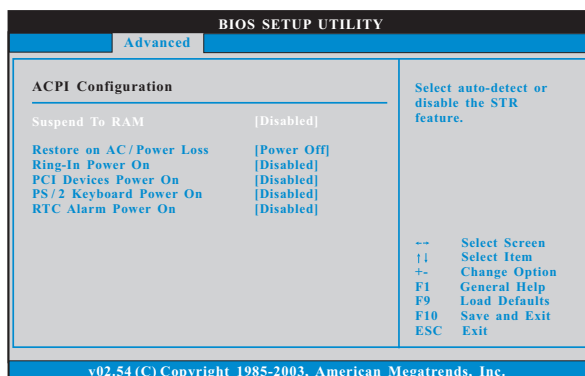

#### Restore on AC/Power Loss

Use this item to set the power state after an unexpected AC/power loss. If [Power Off] is selected, the AC/power remains off when the power recovers. If [Power On] is selected, the AC/power resumes and the system starts to boot up when the power recovers.

#### Ring-In Power On

Use this item to enable or disable Ring-In signals to turn on the system from the power-soft-off mode.

#### PCI Devices Power On

Use this item to enable or disable PCI devices to turn on the system from the power-soft-off mode.

#### PS/2 Keyboard Power On

Use this item to enable or disable PS/2 keyboard to turn on the system from the power-soft-off mode.

#### RTC Alarm Power On

Use this item to enable or disable RTC (Real Time Clock) to power on the system.

### 3.3.4 IDE Configuration

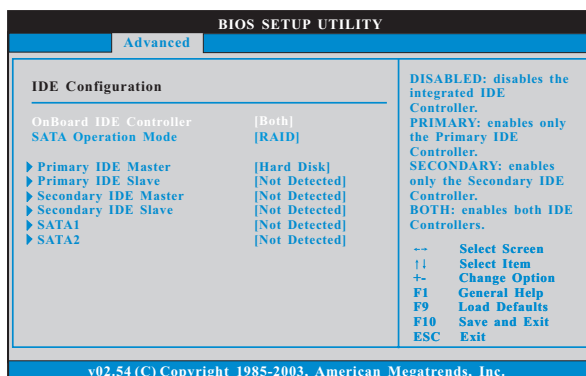

#### OnBoard IDE Controller

You may enable either the primary IDE channel or the secondary IDE channel. Or you may enable both the primary and the secondary IDE channels by selecting [Both]. Set to [Disabled] will disable the both. Configuration options: [Disabled], [Primary], [Secondary], [Both].

#### SATA Operation Mode

Use this item to adjust SATA Operation Mode. The default value of this option is [RAID]. If you don't want to operate RAID function on SATA HDDs, please select [non-RAID].

#### IDE Device Configuration

You may set the IDE configuration for the device that you specify. We will use the "Primary IDE Master" as the example in the following instruction, which can be applied to the configurations of "Primary IDE Slave", "Secondary IDE Master", and "Secondary IDE Slave" as well.

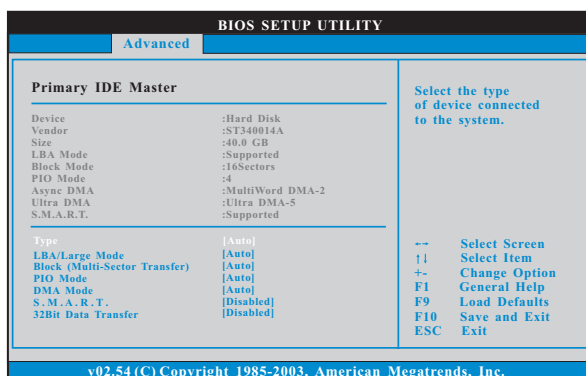

---

### TYPE

Use this item to configure the type of the IDE device that you specify. Configuration options: [Not Installed], [Auto], [CD/DVD], and [ARMD].

**[Not Installed]:** Select [Not Installed] to disable the use of IDE device.

**[Auto]:** Select [Auto] to automatically detect the hard disk drive.



After selecting the hard disk information into BIOS, use a disk utility, such as FDISK, to partition and format the new IDE hard disk drives. This is necessary so that you can write or read data from the hard disk. Make sure to set the partition of the Primary IDE hard disk drives to active.

**[CD/DVD]:** This is used for IDE CD/DVD drives.

**[ARMD]:** This is used for IDE ARMD (ATAPI Removable Media Device), such as MO.

### LBA/Large Mode

Use this item to select the LBA/Large mode for a hard disk > 512 MB under DOS and Windows; for Netware and UNIX user, select [Disabled] to disable the LBA/Large mode.

### Block (Multi-Sector Transfer)

The default value of this item is [Auto]. If this feature is enabled, it will enhance hard disk performance by reading or writing more data during each transfer.

### PIO Mode

Use this item to set the PIO mode to enhance hard disk performance by optimizing the hard disk timing.

### DMA Mode

DMA capability allows the improved transfer-speed and data-integrity for compatible IDE devices.

### S.M.A.R.T.

Use this item to enable or disable the S.M.A.R.T. (Self-Monitoring, Analysis, and Reporting Technology) feature. Configuration options: [Disabled], [Auto], [Enabled].

### 32-Bit Data Transfer

Use this item to enable 32-bit access to maximize the IDE hard disk data transfer rate.

### 3.3.5 PCIPnP Configuration

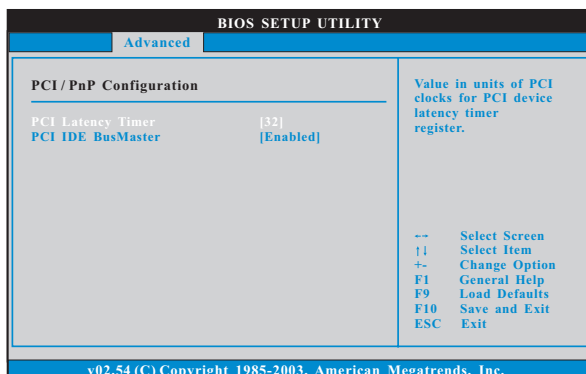

#### PCI Latency Timer

The default value is 32. It is recommended to keep the default value unless the installed PCI expansion cards' specifications require other settings.

#### PCI IDE BusMaster

Use this item to enable or disable the PCI IDE BusMaster feature.

### 3.3.6 Floppy Configuration

In this section, you may configure the type of your floppy drive.

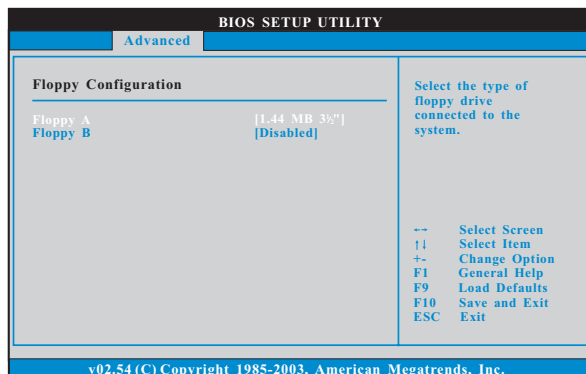

### 3.3.7 Super IO Configuration

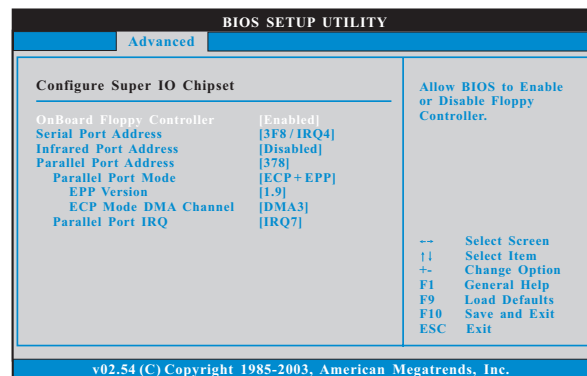

#### OnBoard Floppy Controller

Use this item to enable or disable floppy drive controller.

#### Serial Port Address

Use this item to set the address for the onboard serial port or disable it.

Configuration options: [Disabled], [3F8 / IRQ4], [2F8 / IRQ3], [3E8 / IRQ4], [2E8 / IRQ3].

#### Infrared Port Address

Use this item to set the address for the onboard infrared port or disable it.

Configuration options: [Disabled], [2F8 / IRQ3], and [2E8 / IRQ3].

#### Parallel Port Address

Use this item to set the address for the onboard parallel port or disable it.

Configuration options: [Disabled], [378], and [278].

#### Parallel Port Mode

Use this item to set the operation mode of the parallel port. The default value is [ECP+EPP]. If this option is set to [ECP+EPP], it will show the EPP version in the following item, "EPP Version". Configuration options: [Normal], [Bi-Directional], and [ECP+EPP].

#### EPP Version

Use this item to set the EPP version. Configuration options: [1.9] and [1.7].

#### ECP Mode DMA Channel

Use this item to set the ECP mode DMA channel. Configuration options: [DMA0], [DMA1], and [DMA3].

#### Parallel Port IRQ

Use this item to set the IRQ for the parallel port. Configuration options: [IRQ5] and [IRQ7].

### 3.3.8 USB Configuration

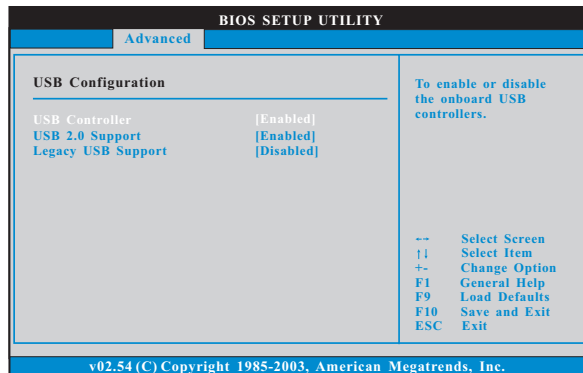

#### USB Controller

Use this item to enable or disable the use of USB controller.

#### USB 2.0 Support

Use this item to enable or disable the USB 2.0 support.

#### Legacy USB Support

Use this item to enable or disable the support to emulate legacy I/O devices such as mouse, keyboard,... etc. Or you may select [Auto] so that the system will start to auto-detect; if there is no USB device connected, "Auto" option will disable the legacy USB support.

### 3.4 Hardware Health Event Monitoring Screen

In this section, it allows you to monitor the status of the hardware on your system, including the parameters of the CPU temperature, motherboard temperature, CPU fan speed, chassis fan speed, and the critical voltage.

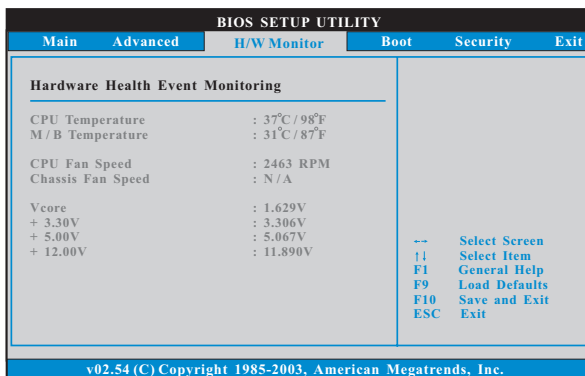

### 3.5 Boot Screen

In this section, it will display the available devices on your system for you to configure the boot settings and the boot priority.





### 3.5.1 Boot Settings Configuration

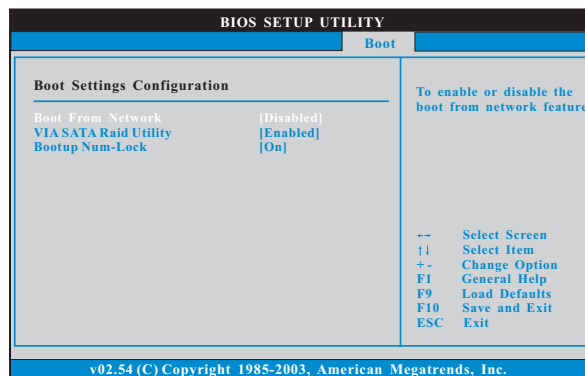

#### Boot From Network

Use this item to enable or disable the Boot From Network feature.

#### VIA SATA Raid Utility

Use this to enable or disable VIA VT8237 SATA Raid BIOS Utility during POST.

#### Boot Up Num-Lock

If this item is set to [On], it will automatically activate the Numeric Lock function after boot-up.

### 3.6 Security Screen

In this section, you may set or change the supervisor/user password for the system. For the user password, you may also clear it.

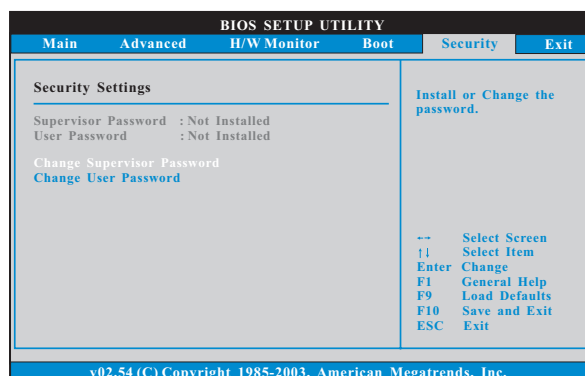

### 3.7 Exit Screen

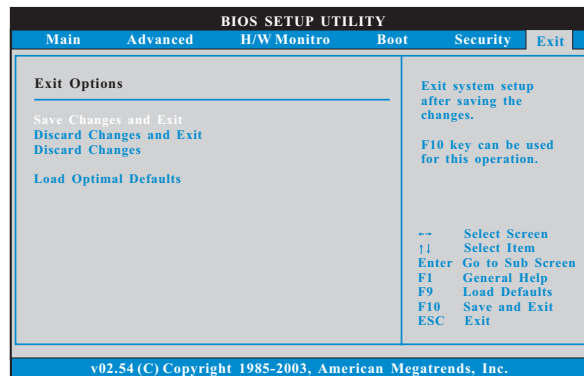

#### Save Changes and Exit

When you select this option, it will pop-out the following message, "Save configuration changes and exit setup?" Select [OK] to save the changes and exit the BIOS SETUP UTILITY.

#### Discard Changes and Exit

When you select this option, it will pop-out the following message, "Discard changes and exit setup?" Select [OK] to exit the BIOS SETUP UTILITY without saving any changes.

#### Discard Changes

When you select this option, it will pop-out the following message, "Discard changes?" Select [OK] to discard all changes.

#### Load Optimal Defaults

When you select this option, it will pop-out the following message, "Load optimal defaults?" Select [OK] to load the default values for all the setup configurations.

---

## **4. Software Support**

### **4.1 Install Operating System**

This motherboard supports various Microsoft® Windows® operating systems: 98 SE / ME / 2000 / XP. Because motherboard settings and hardware options vary, use the setup procedures in this chapter for general reference only. Refer to your OS documentation for more information.

### **4.2 Support CD Information**

The Support CD that came with the motherboard contains necessary drivers and useful utilities that enhance the motherboard features.

#### **4.2.1 Running The Support CD**

To begin using the support CD, insert the CD into your CD-ROM drive. The CD automatically displays the Main Menu if "AUTORUN" is enabled in your computer. If the Main Menu did not appear automatically, locate and double click on the file "ASSETUP.EXE" from the BIN folder in the Support CD to display the menus.

#### **4.2.2 Drivers Menu**

The Drivers Menu shows the available devices drivers if the system detects installed devices. Please install the necessary drivers to activate the devices.

#### **4.2.3 Utilities Menu**

The Utilities Menu shows the applications software that the motherboard supports. Click on a specific item then follow the installation wizard to install it.

#### **4.2.4 Contact Information**

If you need to contact ASRock or want to know more about ASRock, welcome to visit ASRock's website at <http://www.asrock.com>; or you may contact your dealer for further information.