

6 V Photovoltaic Power Converter

PPC-6E

**Key Features**

- Up to 100 mA at 5 V
- Up to 500 mW electrical power
- Up to 6 volts output
- Optimized for 810 nm source
- Complete electrical isolation

Applications

- Optically powered current transducer for electrical power transmission
- Remote optically powered sensors and transducers
- Compatible with 62.5 μm short-haul “legacy” fiber
- Low cost and efficient 808 or 830 nm laser diode source
- Remote antenna lightning isolation

The PPC-6E is a photovoltaic power converter optimized for maximum efficiency in the range of 790 – 850 nm illumination. Source optical energy is delivered via multimode fiber, compatible with installed short haul communication systems. Reliable and low cost laser diodes are readily available as sources.

Total electrical isolation, and compatibility of operation in high electrical field or noisy electrical environments are key capabilities of the PPC-6E. Remote power for sensors, transducers and data communications equipment are typical applications.

Designed to convert 790 – 850 nm light into electrical power up to 6 Volts, with output power from a few mW to 0.5 W, the PPC-6E is available with ST or FC connectors. Pigtail packages including ceramic (CMPT) pigtail are available.

2

PPC-6E at 3 Light Input Levels

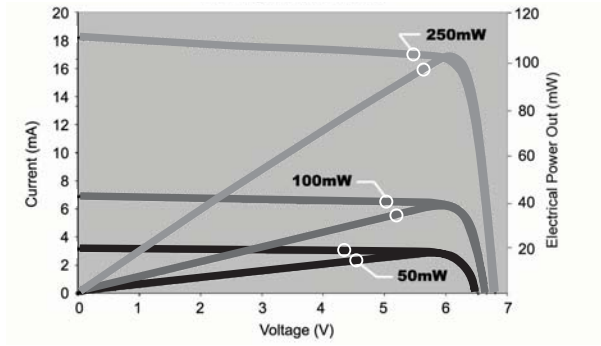

Optimum Load Resistance for PPC-6E

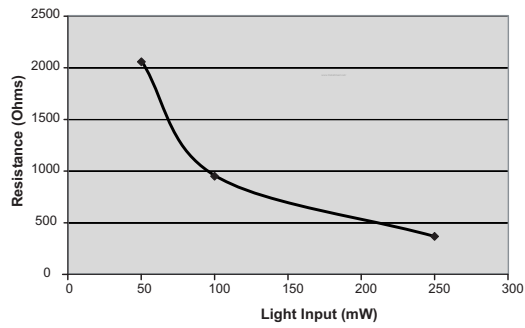

FC Housing

(Pin orientation may vary. Specifications in mm unless otherwise noted. All dimensions tolerance $\pm 250 \mu$)

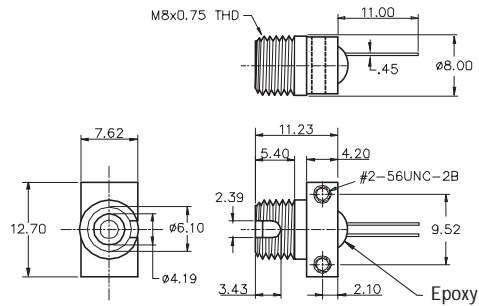

ST Housing

(Pin orientation may vary. Specifications in mm unless otherwise noted. All dimensions tolerance $\pm 250 \mu$)

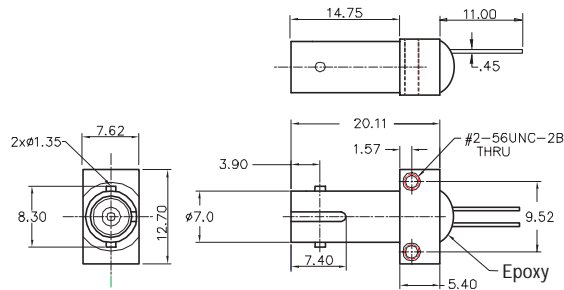
Ordering Information

For more information on this or other products and their availability, please contact your local JDSU account manager or JDSU directly at 1-800-498-JDSU (5378) in North America and +800-5378-JDSU worldwide or via e-mail at customer.service@jdsu.com.

All statements, technical information and recommendations related to the products herein are based upon information believed to be reliable or accurate. However, the accuracy or completeness thereof is not guaranteed, and no responsibility is assumed for any inaccuracies. The user assumes all risks and liability whatsoever in connection with the use of a product or its application. JDSU reserves the right to change at any time without notice the design, specifications, function, fit or form of its products described herein, including withdrawal at any time of a product offered for sale herein. JDSU makes no representations that the products herein are free from any intellectual property claims of others. Please contact JDSU for more information. JDSU and the JDSU logo are trademarks of JDS Uniphase Corporation. Other trademarks are the property of their respective holders. ©2005 JDS Uniphase Corporation. All rights reserved. 30137221 Rev. 001 10/05 PPC6E.DS.PP.AE