

# BG20B

## 5-800 MHz Internally Matched IF Amplifier



### Device Features

- OIP3 = 41.0 dBm @ 70 MHz
- Gain = 22.0 dB @ 70 MHz
- Output P1 dB = 21.0 dBm @ 70 MHz
- 50 Ω Cascadable
- Patented temperature compensation
- Lead-free/RoHS-compliant SOT-89 SMT package



### Product Description

BeRex's BG20B is a high performance InGaP/ GaAs HBT MMIC amplifier, internally matched to 50 Ohms and uses a patented **temperature compensation** circuit to provide stable current over the operating temperature range without the need for external components. The BG20B is designed for high linearity IF amplifier that requires excellent gain, high OIP3 and flatness. It is packaged in a RoHS-compliant with SOT-89 surface mount package.

### Typical Performance<sup>1</sup>

Parameter	Frequency					Unit
	70	140	250	500	800	
Gain	22.0	21.9	21.7	21.0	20.5	dB
S11	-23.5	-26.5	-27.0	-25.5	-23.2	dB
S22	-18.0	-21.5	-20.0	-16.0	-12.2	dB
OIP3 <sup>2</sup>	41.0	39.5	38.5	36.0	31.0	dBm
P1dB	21.0	21.0	21.0	21.0	19.0	dBm
Noise Figure	4.6	4.7	4.7	4.8	4.8	dB

<sup>1</sup> Device performance \_ measured on a BeRex evaluation board at 25°C, 50 Ω system.

<sup>2</sup> OIP3 \_ measured with two tones at an output of 13 dBm per tone separated by 1 MHz.

### Applications

- Base station Infrastructure/RFID
- Commercial/Industrial/Military wireless system

### Applications Circuit

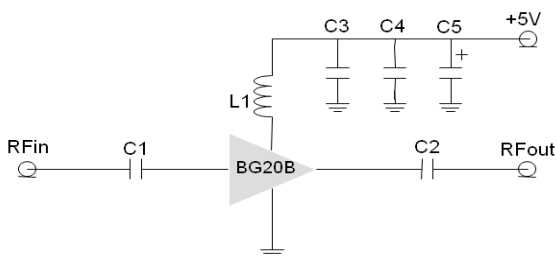

\*C1, C2=2700pF ± 5%; C3 = 100 pF ± 5%; C4 = 1000pF ± 5%

\*C5 = 10uF; L1 = 470nH ± 5%

	Min.	Typical	Max.	Unit
Bandwidth	5		800	MHz
I <sub>C</sub> @ (V <sub>C</sub> = 5V)	95	105	115	mA
V <sub>C</sub>		5.0		V
dG/dT		-0.002		dB/°C
R <sub>TH</sub>		50		°C/W

### Absolute Maximum Ratings

Parameter	Rating	Unit
Operating Case Temperature	-40 to +85	°C
Storage Temperature	-55 to +155	°C
Junction Temperature	+220	°C
Operating Voltage	+6.0	V
Supply Current	200	mA
Input RF Power	23	dBm

Operation of this device above any of these parameters may result in permanent damage.

# BG20B

5-800 MHz Internally Matched IF Amplifier



## V-I Characteristics

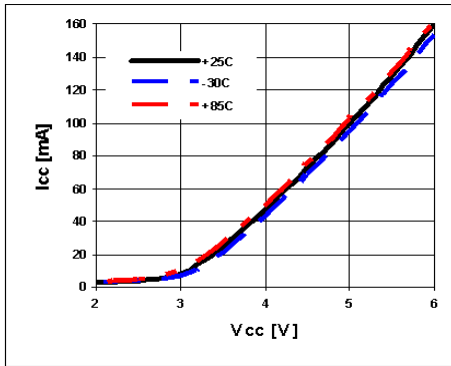

## BeRex SOT89 Evaluation Board

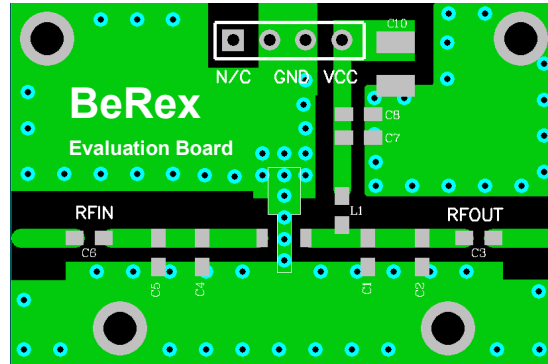

\*Dielectric constant \_ 4.2 \*RF pattern width 52mil \*31mil thick FR4 PCB

## Typical Device Data

S-parameters (Vc=5V, Ic=105mA, T=25°C)

CH1 LOG 10 dB/ REF 0 dB  
S11 2:-26.642 dB 140.000 000 MHz

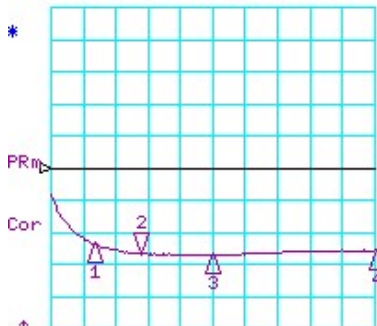

CH1 Markers  
1:-23.588 dB  
70.0000 MHz  
3:-27.178 dB  
250.000 MHz  
4:-25.687 dB  
500.000 MHz

START 5.000 MHz STOP 500.000 MHz

CH3 LOG 10 dB/ REF 0 dB  
S13 2:-28.018 dB 140.000 000 MHz

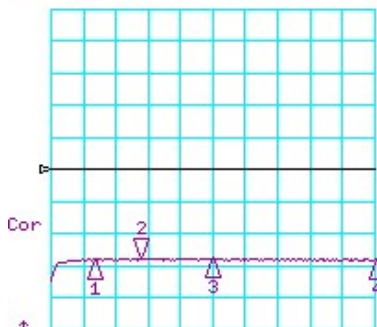

CH3 Markers  
1:-28.161 dB  
70.0000 MHz  
3:-28.052 dB  
250.000 MHz  
4:-28.234 dB  
500.000 MHz

START 5.000 MHz STOP 500.000 MHz

CH2 LOG 10 dB/ REF 0 dB  
S31 2: 21.771 dB 140.000 000 MHz

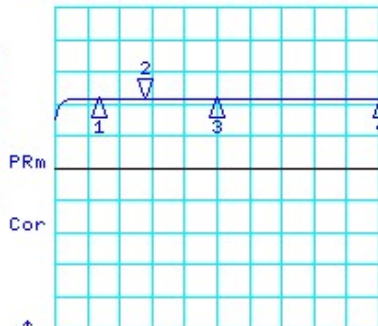

CH2 Markers  
1: 21.716 dB  
70.0000 MHz  
3: 21.674 dB  
250.000 MHz  
4: 21.338 dB  
500.000 MHz

START 5.000 MHz STOP 500.000 MHz

CH4 LOG 10 dB/ REF 0 dB  
S33 2:-21.349 dB 140.000 000 MHz

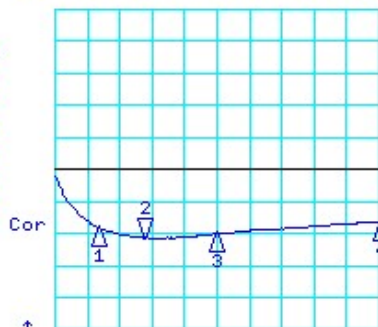

CH4 Markers  
1:-18.062 dB  
70.0000 MHz  
3:-19.970 dB  
250.000 MHz  
4:-16.162 dB  
500.000 MHz

START 5.000 MHz STOP 500.000 MHz



### S-Parameter

(V<sub>device</sub> = 5.0V, I<sub>cc</sub> = 99mA, T = 25 °C, calibrated to device leads)

Freq [MHz]	S11 [Mag]	S11 [Ang]	S21 [Mag]	S21 [Ang]	S12 [Mag]	S12 [Ang]	S22 [Mag]	S22 [Ang]
10	0.293	-57.621	9.026	-133.913	0.029	46.255	0.616	141.423
50	0.088	-114.698	12.090	-176.377	0.039	6.825	0.172	71.829
100	0.054	-148.463	12.277	170.024	0.040	-3.437	0.101	31.482
150	0.046	-176.865	12.246	160.120	0.040	-10.235	0.086	-2.318
200	0.045	162.862	12.226	151.169	0.039	-15.933	0.089	-28.165
250	0.044	146.555	12.127	142.934	0.040	-21.800	0.100	-46.876
300	0.046	131.631	12.088	134.539	0.039	-26.571	0.111	-59.613
350	0.049	120.839	11.925	126.455	0.039	-31.386	0.122	-69.609
400	0.050	113.381	11.924	118.460	0.039	-36.144	0.132	-79.222
450	0.052	104.506	11.695	110.451	0.039	-41.080	0.144	-87.009
500	0.052	93.956	11.668	103.010	0.039	-45.503	0.157	-93.192

Typical Performance (V<sub>c</sub> = 5V, V<sub>device</sub>\*=4.85V, I<sub>c</sub> = 99mA, T = 25°C)

Freq	MHz	70	140	250	500	800
S21	dB	22.0	21.9	21.7	21.0	20.5
S11	dB	-23.5	-26.5	-27.0	-25.5	-23.2
S22	dB	-18.0	-21.5	-20.0	-16.0	-12.2
P1	dBm	21	21	21	21	19
OIP3	dBm	41	39.5	38.5	36	31
NF	dB	4.6	4.7	4.7	4.8	4.8

\*4.85V at the device is due to 0.15V drop across 470nH choke inductor.

Typical Performance (V<sub>d</sub> = 4.7V, I<sub>c</sub> = 92mA, T = 25°C)

Freq	MHz	70	140	250	500	800
S21	dB	21.8	21.7	21.6	21.2	20.5
S11	dB	-23.4	-30.3	-33.7	-28.4	-23.2
S22	dB	-16.1	-16.1	-16.8	-16.5	-12
P1	dBm	20	20.6	20.7	20.1	18.7
OIP3	dBm	40	39	37	33.5	30
NF	dB	4.6	4.7	4.7	4.8	4.8

Typical Performance (V<sub>d</sub> = 4.5V, I<sub>c</sub> = 79mA, T = 25°C)

Freq	MHz	70	140	250	500	800
S21	dB	21.8	21.8	21.6	20.9	20.4
S11	dB	-23.8	-30.5	-34.3	-29	-23.2
S22	dB	-15.8	-15.8	-16.5	-16.2	-11.8
P1	dBm	19.8	19.3	19.2	19.6	17.9
OIP3	dBm	34.0	37.0	35.5	35.5	29.5
NF	dB	4.6	4.7	4.7	4.8	4.8

# BG20B



## 5-800 MHz Internally Matched IF Amplifier

Typical Performance (Vd = 4V, Ic = 51mA, T = 25°C)

Freq	MHz	70	140	250	500	800
S21	dB	21.4	21.3	21.2	20.9	20.1
S11	dB	-26.1	-28.1	-29.3	-28.5	-22.3
S22	dB	-15.0	-14.6	-15.1	-15.1	-11.2
P1	dBm	17.3	17.4	17.4	17.1	15.8
OIP3	dBm	31.0	32.0	31.0	29.0	27.5
NF	dB	4.6	4.7	4.7	4.8	4.8

Typical Performance (Vd = 3.5V, Ic = 26mA, T = 25°C)

Freq	MHz	70	140	250	500	800
S21	dB	20.3	20.2	20.1	19.8	19.1
S11	dB	-21.8	-19.4	-19.3	-20.3	-18.3
S22	dB	-12.1	-11.5	-12.0	-12.4	-9.9
P1	dBm	11.8	11.7	12.0	11.1	11.0
OIP3	dBm	22.5	23.5	22.5	22.0	22.5
NF	dB	4.6	4.7	4.7	4.8	4.8

### Device Performance

#### Pin-Pout-Gain

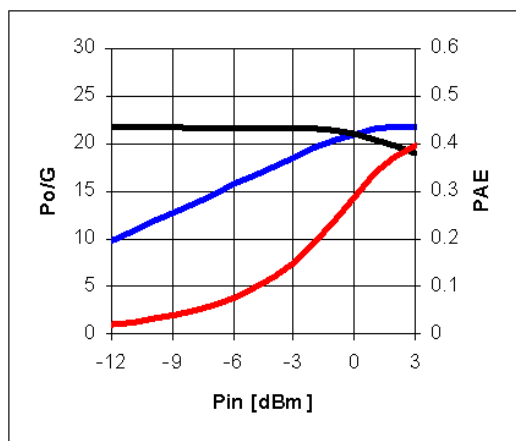

200MHz, 5V/99mA

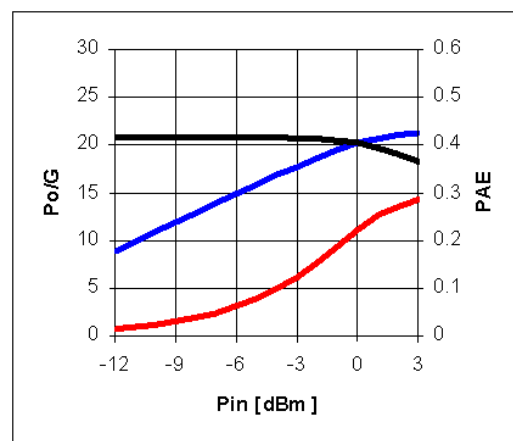

500 MHz, 5V/99mA

# BG20B

## 5-800 MHz Internally Matched IF Amplifier



### OIP3

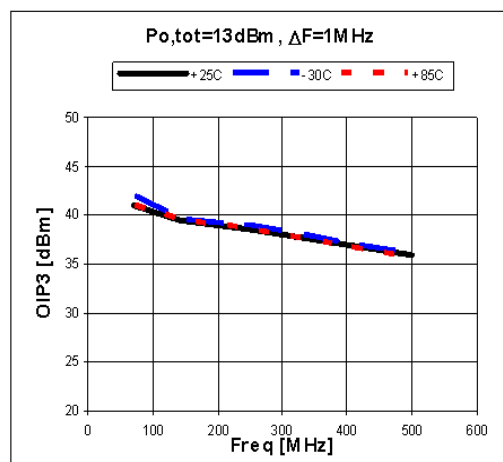
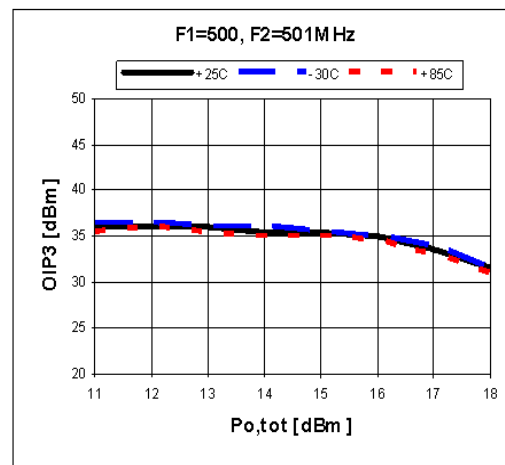
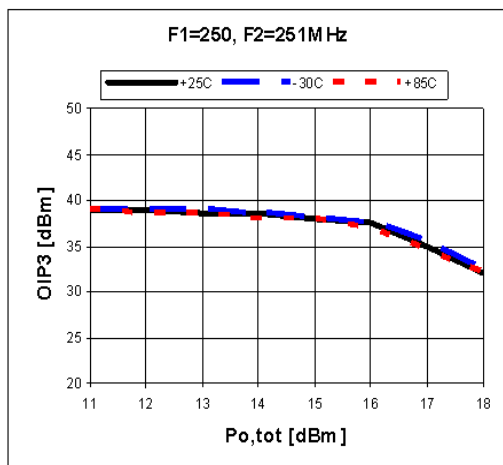
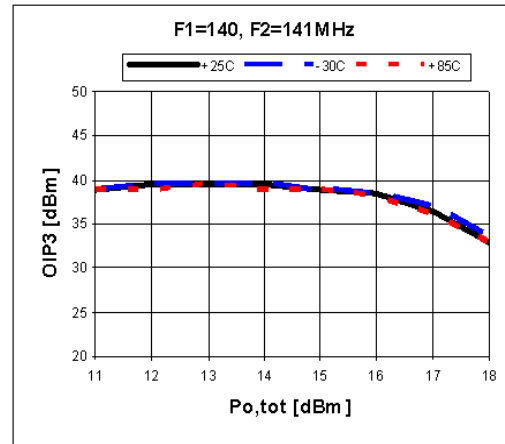
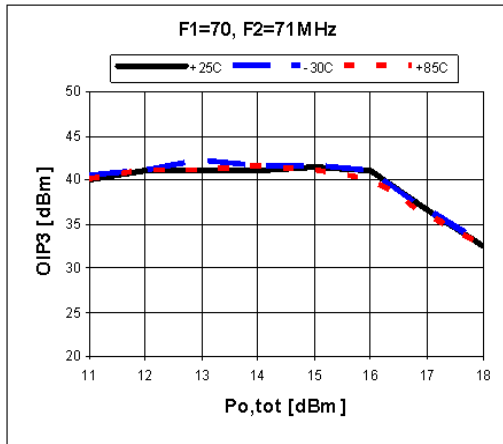

# BG20B

## 5-800 MHz Internally Matched IF Amplifier



### ACPR

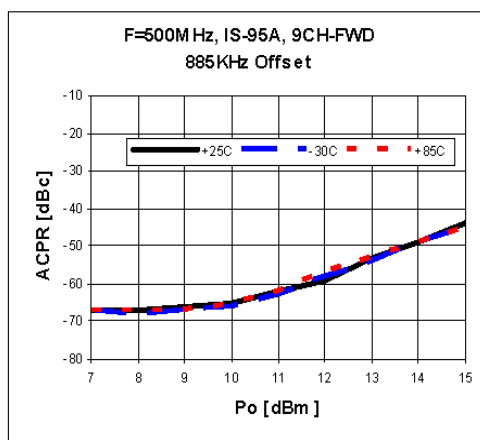
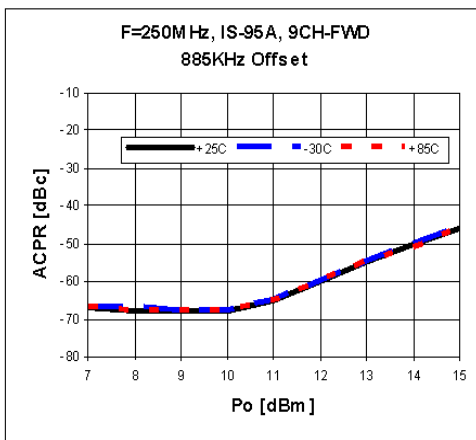
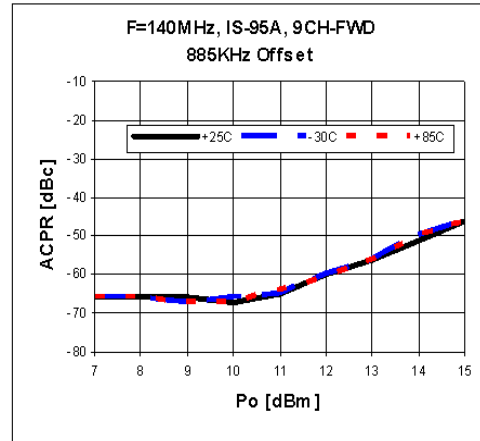
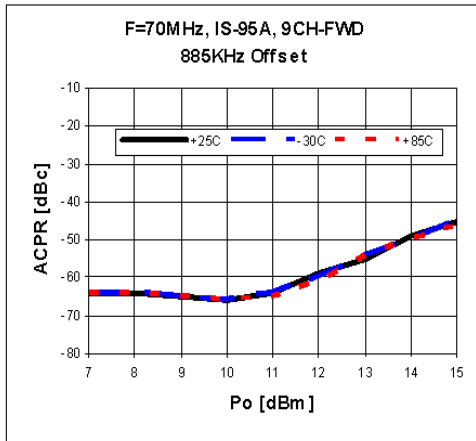

# BG20B

5-800 MHz Internally Matched IF Amplifier



## ACLR

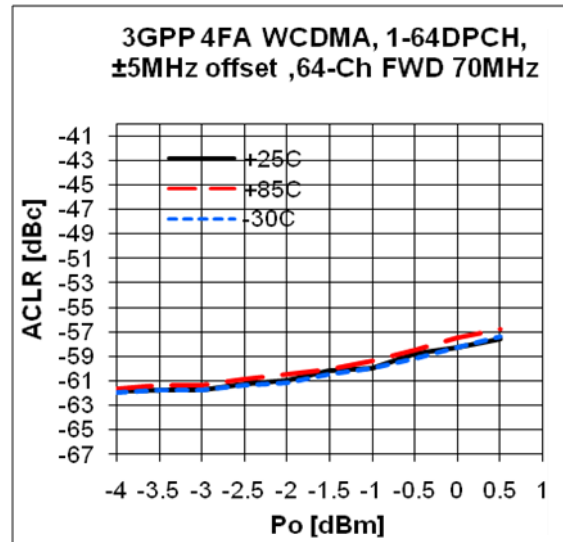

## Gain Flatness

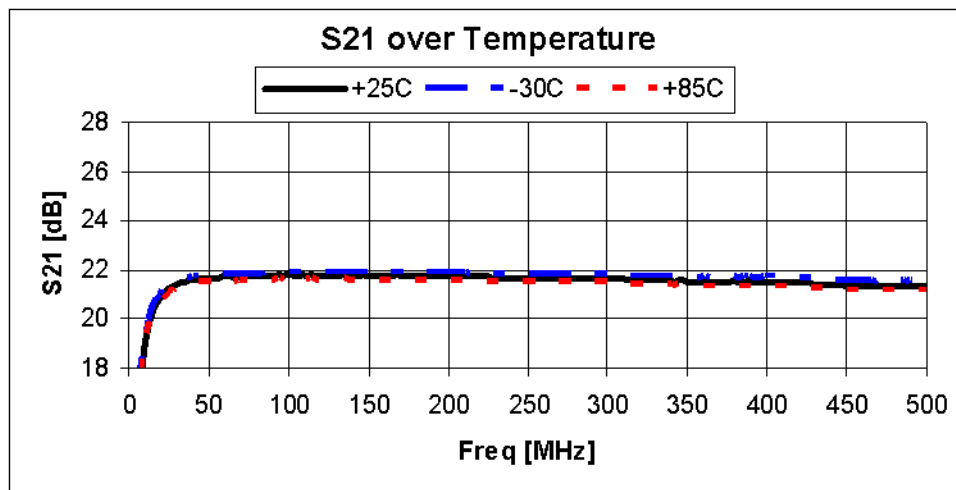

# BG20B

## 5-800 MHz Internally Matched IF Amplifier



### Package Outline Dimension

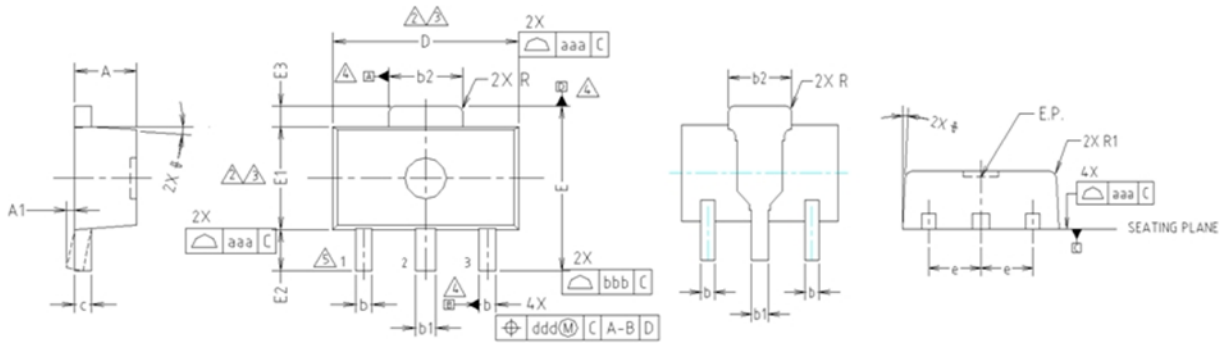

- NOTE:**  
1. DIMENSIONS IN MILLIMETERS.
- ⚠ DIMENSION D DOES NOT INCLUDE MOLD FLASH, PROTRUSIONS OR GATE BURRS. MOLD FLASH, PROTRUSIONS OR GATE BURRS SHALL NOT EXCEED 0.5mm PER END. DIMENSION E1 DOES NOT INCLUDE INTERLEAD FLASH OR PROTRUSION. INTERLEAD FLASH OR PROTRUSION SHALL NOT EXCEED 0.5mm PER SIDE.
  - ⚠ DIMENSIONS D AND E1 ARE DETERMINED AT THE OUTMOST EXTREMES OF THE PLASTIC BODY EXCLUSIVE OF MOLD FLASH, TIE BAR BURRS, GATE BURRS AND INTERLEAD FLASH, BUT INCLUDING ANY MISMATCH BETWEEN THE TOP AND BOTTOM OF THE PLASTIC BODY.
  - ⚠ DATUMS A, B AND D TO BE DETERMINED 0.18mm FROM THE LEAD TIP.
  - ⚠ TERMINAL NUMBERS ARE SHOWN FOR REFERENCE ONLY.

SYMBOL	MILLIMETERS			NOTE
	MINIMUM	NOMINAL	MAXIMUM	
A	1.40	1.50	1.60	
A1	0.00	—	0.10	
b	0.38	0.42	0.48	
b1	0.48	0.52	0.58	
b2	1.79	1.82	1.87	
c	0.40	0.42	0.46	
D	4.40	4.50	4.70	2,3
E	3.70	4.00	4.30	
E1	2.40	2.50	2.70	2,3
E2	0.80	1.00	1.20	
E3	0.40	0.50	0.60	
e	1.50 TYP.			
φ	4° TYP.			
R	0.15 TYP.			
R1	—	—	0.20	
SYMBOL	TOLERANCES OF FORM AND POSITION		NOTE	
aaa	0.15			
bbb	0.20			
ccc	0.10			
ddd	0.10			

### Suggested PCB Land Pattern and PAD Layout

#### PCB Land Pattern

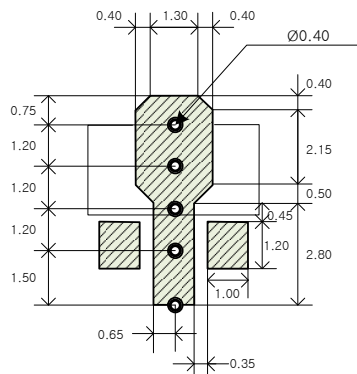

Note : All dimension \_ millimeters

PCB lay out \_ on BeRex website

#### PCB Mounting

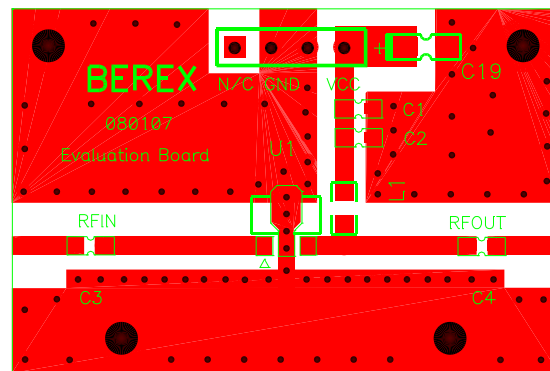



# BG20B

5-800 MHz Internally Matched IF Amplifier



## Tape & Reel

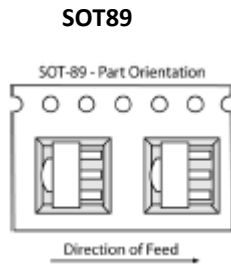

Packaging information:

Tape Width (mm): 12

Reel Size (inches): 7

Device Cavity Pitch (mm): 8

Devices Per Reel: 1000

## Lead plating finish

100% Tin Matte finish

(All BeRex products undergoes a 1 hour, 150 degree C, Anneal bake to eliminate thin whisker growth concerns.)

## MSL / ESD Rating

<b>ESD Rating:</b>	Class 1C
<b>Value:</b>	<b>Passes &lt;2000V</b>
<b>Test:</b>	Human Body Model (HBM)
<b>Standard:</b>	JEDEC Standard JESD22-A114B
<b>MSL Rating:</b>	<b>Level 1 at +265°C convection reflow</b>
<b>Standard:</b>	JEDEC Standard J-STD-020

## NATO CAGE code:

2	N	9	6	F
---	---	---	---	---