



## InGaP HBT 1 WATT POWER AMPLIFIER, 0.4 - 2.2 GHz

### Typical Applications

The HMC452QS16G / HMC452QS16GE is ideal for applications requiring a high dynamic range amplifier:

- GSM, GPRS & EDGE
- CDMA & W-CDMA
- CATV/Cable Modem
- Fixed Wireless & WLL

### Features

- Output IP3: +48 dBm
- 22.5 dB Gain @ 400 MHz
- 9 dB Gain @ 2100 MHz
- 53% PAE @ +31 dBm Pout
- +24 dBm CDMA2000 Channel Power @ -45 dBc ACP
- Single +5V Supply
- Integrated Power Control (VPD)
- QSOP16G SMT Package: 29.4 mm<sup>2</sup>

### Functional Diagram

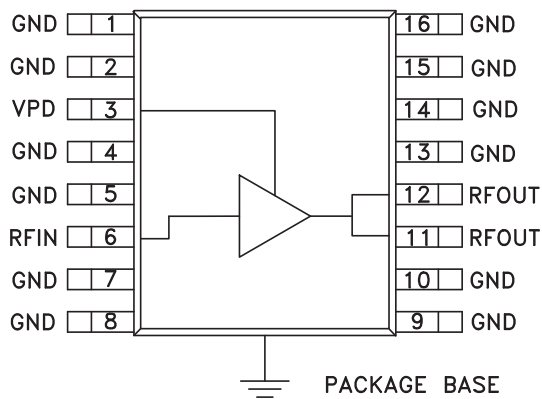

### General Description

The HMC452QS16G & HMC452QS16GE are high dynamic range GaAs InGaP Heterojunction Bipolar Transistor (HBT) 1 watt MMIC power amplifiers operating between 0.4 and 2.2 GHz. Packaged in a miniature 16 lead QSOP plastic package, the amplifier gain is typically 22.5 dB at 0.4 GHz and 9 dB at 2.1 GHz. Utilizing a minimum number of external components and a single +5V supply, the amplifier output IP3 can be optimized to +43 dBm at 0.4 GHz or +48 dBm at 2.1 GHz. The power control (VPD) can be used for full power down or RF output power/current control. The high output IP3 and PAE make the HMC452QS16G(E) ideal power amplifiers for Cellular/PCS/3G, WLL, ISM and Fixed Wireless applications.

### Electrical Specifications, $T_A = +25^\circ\text{C}$ , $V_S = +5\text{V}$ , $VPD = +5\text{V}$ [1]

Parameter	Min.	Typ.	Max.	Min.	Typ.	Max.	Min.	Typ.	Max.	Min.	Typ.	Max.	Min.	Typ.	Max.	Units
Frequency Range	400 - 410			450 - 496			810 - 960			1710 - 1990			2010 - 2170			MHz
Gain	20	22.5		19	21.5		13	15.5		7.5	10		6.5	9		dB
Gain Variation Over Temperature		0.012	0.02		0.012	0.02		0.012	0.02		0.012	0.02		0.012	0.02	dB/C
Input Return Loss		13			15			9			17			11		dB
Output Return Loss		7			8			12			15			20		dB
Output Power for 1dB Compression (P1dB)	27.5	30.5		27.5	30.5		27	30		28	31		28	31		dBm
Saturated Output Power (Psat)		31			31			31			31.5			32.5		dBm
Output Third Order Intercept (IP3) [2]	40	43		41	44		45	48		45	48		45	48		dBm
Noise Figure		7			7			7			7			7.5		dB
Supply Current (Icq)		485			485			485			485			485		mA
Control Current (IPD)		10			10			10			10			10		mA

[1] Specifications and data reflect HMC452QS16G measured using the respective application circuits for each designated frequency band found herein. Contact the HMC Applications Group for assistance in optimizing performance for your application.

[2] Two-tone input power of -10 dBm per tone, 1 MHz spacing.



### Broadband Gain & Return Loss @ 400 MHz

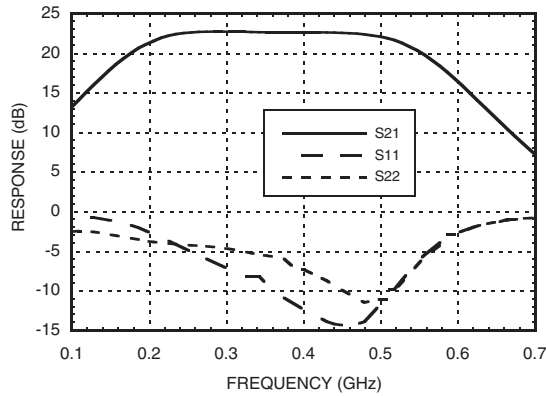

### Gain vs. Temperature @ 400 MHz

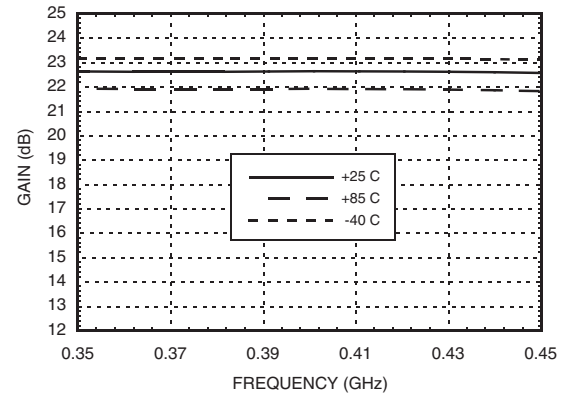

### Input Return Loss vs. Temperature @ 400 MHz

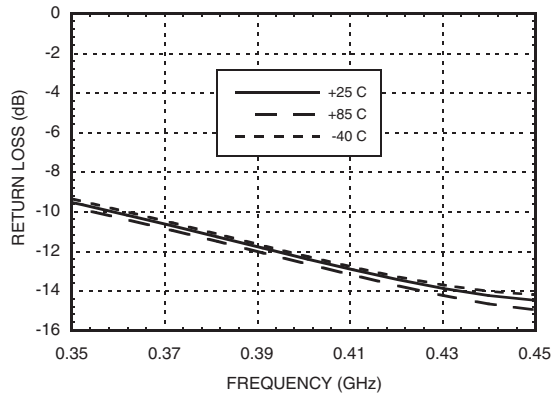

### Output Return Loss vs. Temperature @ 400 MHz

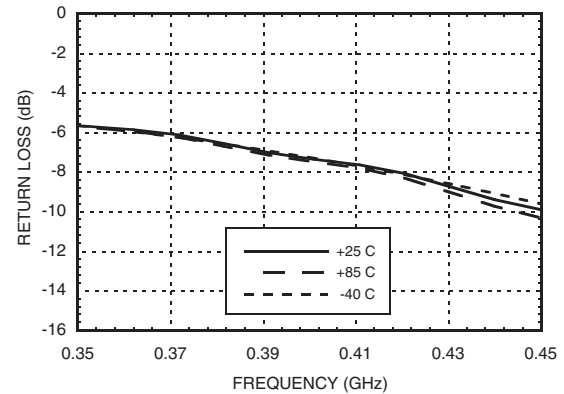

### P1dB vs. Temperature @ 400 MHz

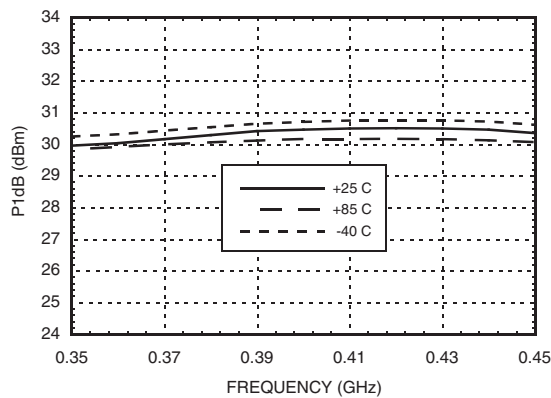

### Psat vs. Temperature @ 400 MHz

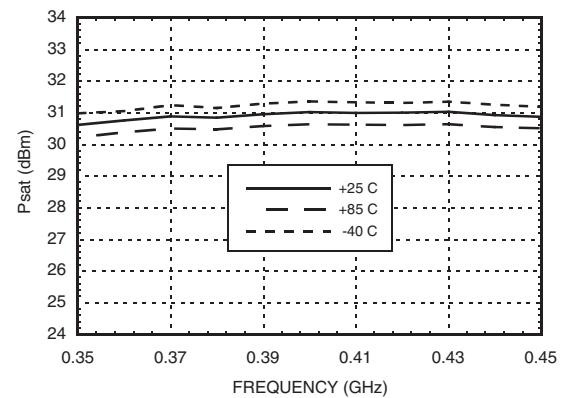



MICROWAVE CORPORATION v01.0205



# HMC452QS16G / 452QS16GE

## InGaP HBT 1 WATT POWER AMPLIFIER, 0.4 - 2.2 GHz

### Output IP3 vs. Temperature @ 400 MHz

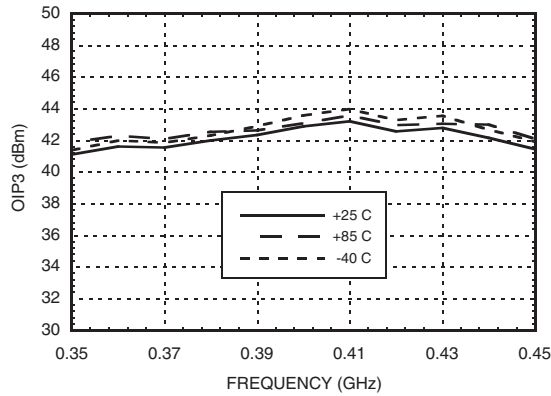

### Noise Figure vs. Temperature @ 400 MHz

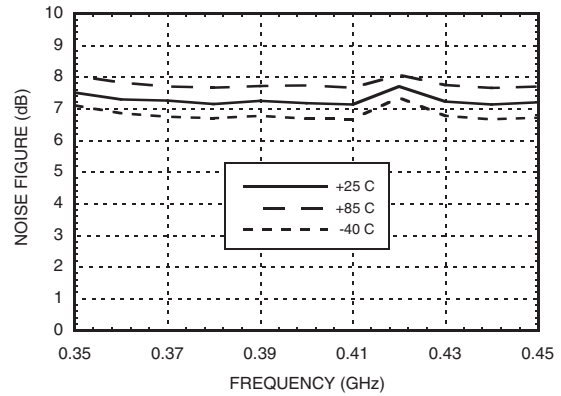

### Reverse Isolation vs. Temperature @ 400 MHz

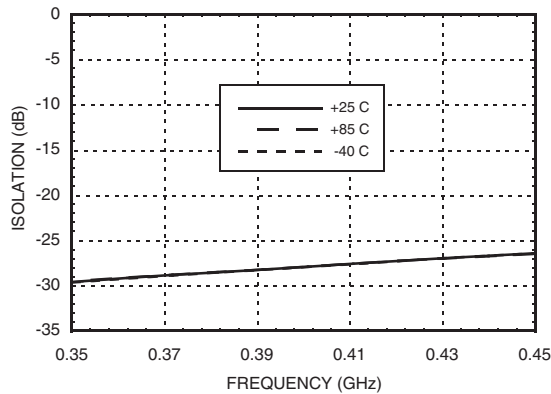

### Gain, Power & IP3 vs. Supply Voltage @ 400 MHz

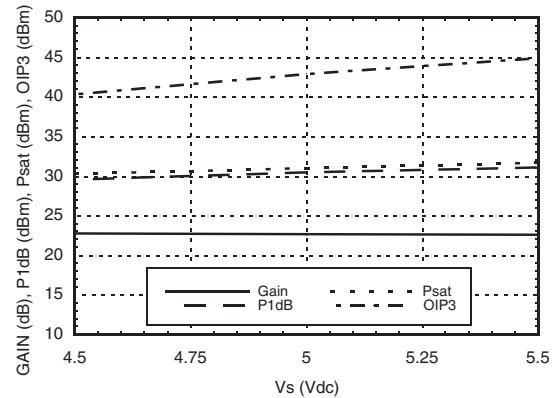

### Power Compression @ 400 MHz

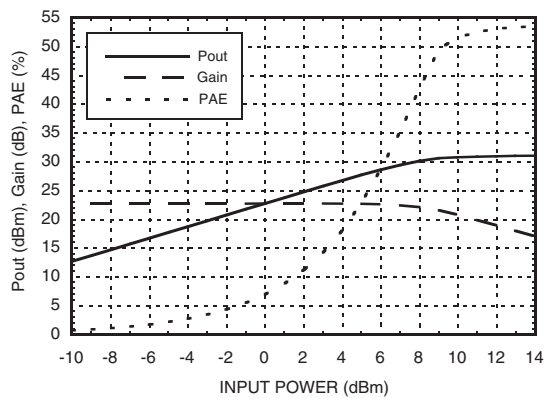

### ACPR vs. Supply Voltage @ 400 MHz W-CDMA, 64 DPCH

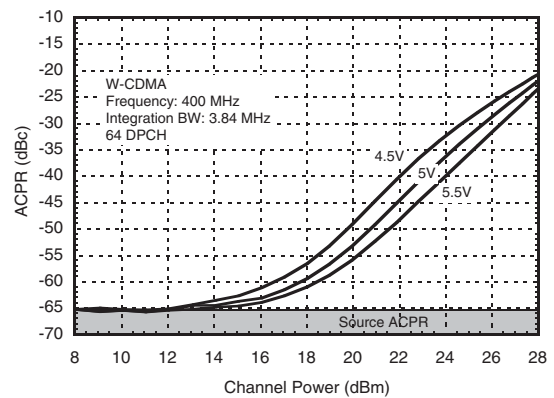

11

LINEAR & POWER AMPLIFIERS - SMT



### Broadband Gain & Return Loss @ 470 MHz

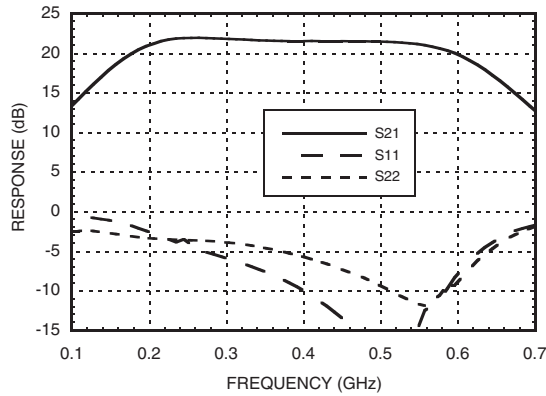

### Gain vs. Temperature @ 470 MHz

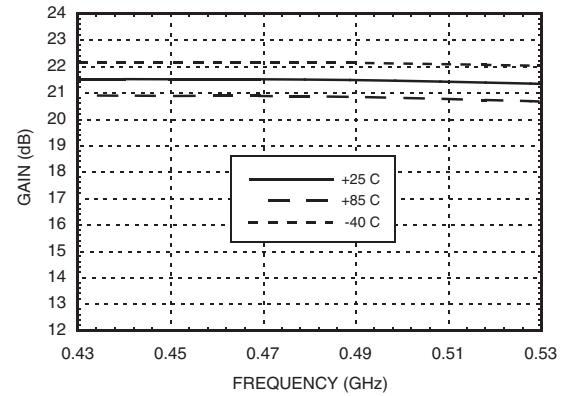

### Input Return Loss vs. Temperature @ 470 MHz

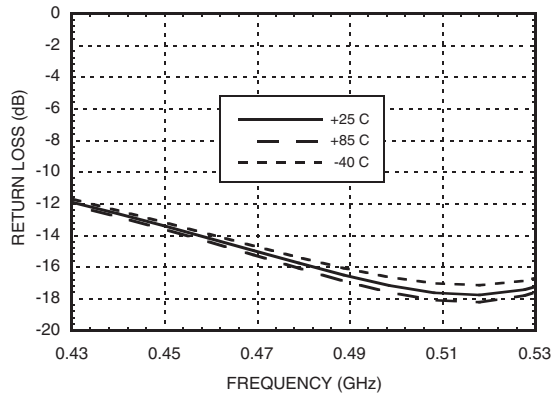

### Output Return Loss vs. Temperature @ 470 MHz

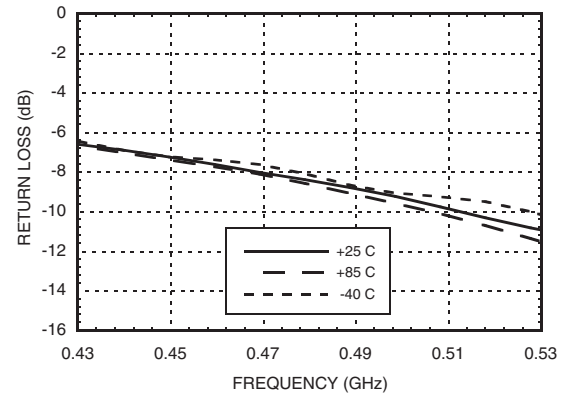

### P1dB vs. Temperature @ 470 MHz

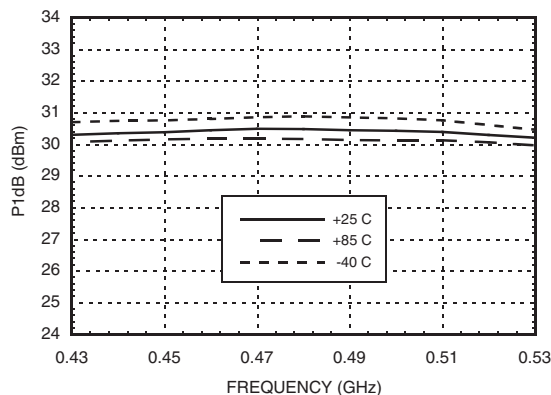

### Psat vs. Temperature @ 470 MHz

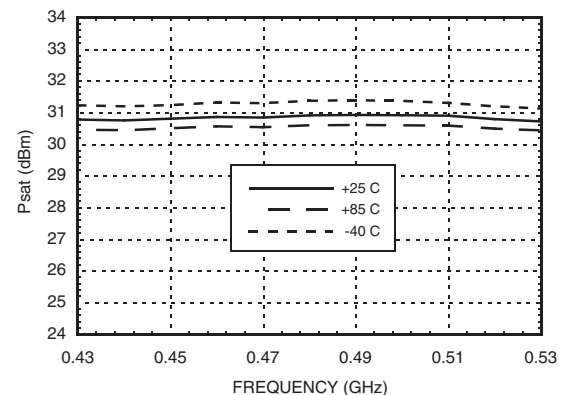

11

LINEAR & POWER AMPLIFIERS - SMT

**Output IP3 vs. Temperature @ 470 MHz**

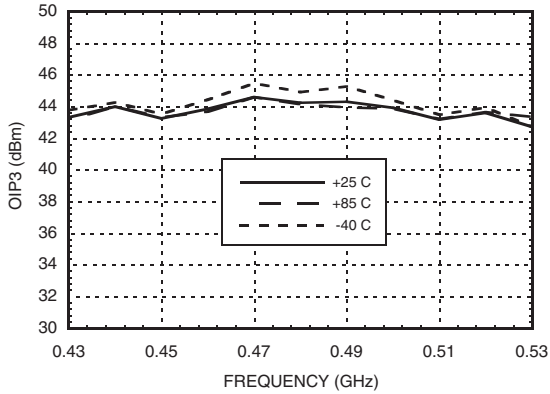

**Noise Figure vs. Temperature @ 470 MHz**

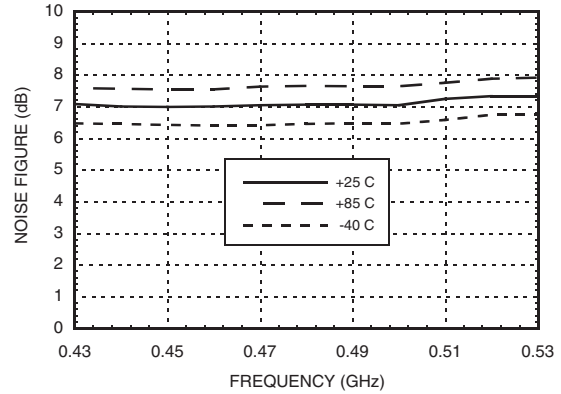

**Reverse Isolation vs. Temperature @ 470 MHz**

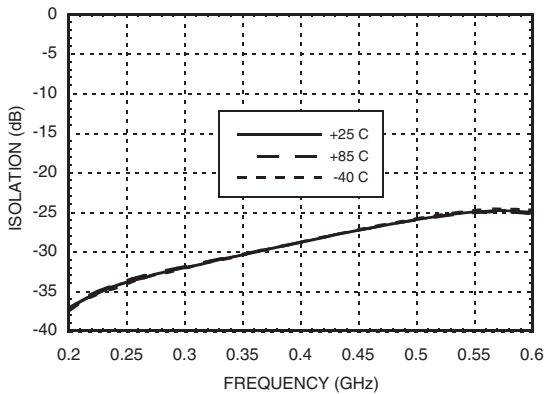

**Gain, Power & IP3 vs. Supply Voltage @ 470 MHz**

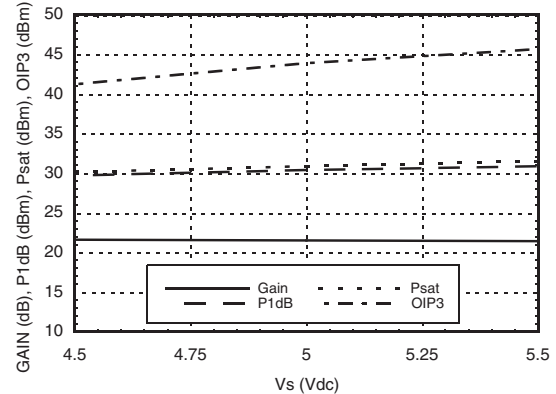

**Power Compression @ 470 MHz**

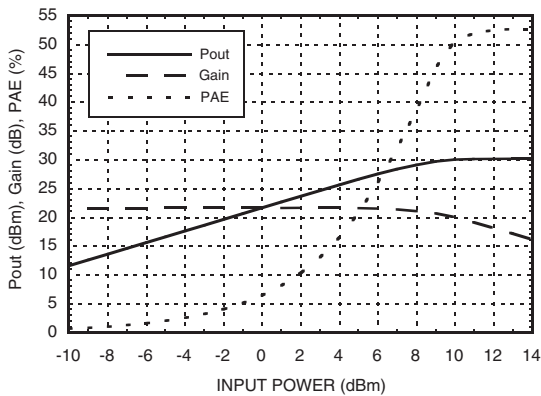

**ACPR vs. Supply Voltage @ 470 MHz W-CDMA, 64 DPCH**

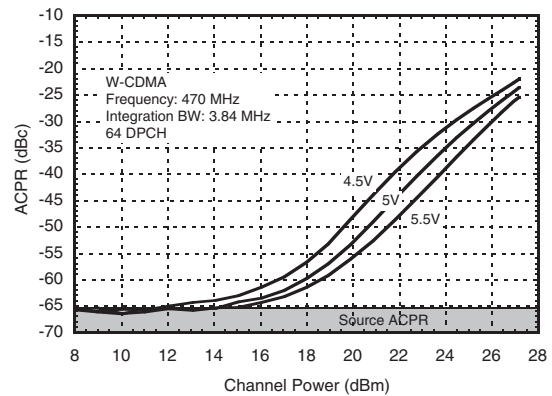



### Broadband Gain & Return Loss @ 900 MHz

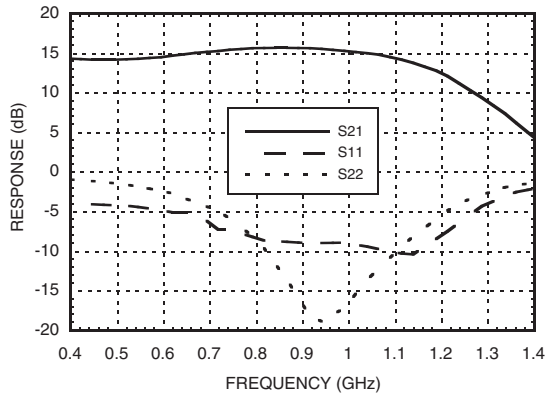

### Gain vs. Temperature @ 900 MHz

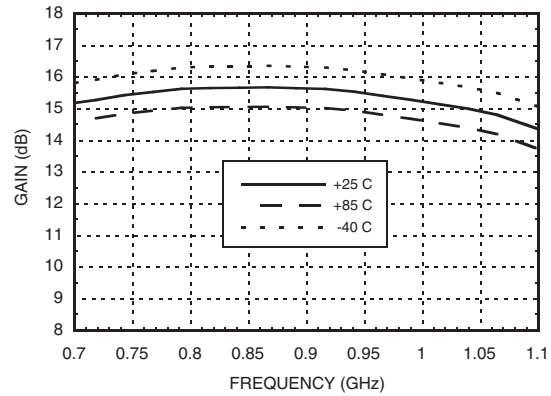

### Input Return Loss vs. Temperature @ 900 MHz

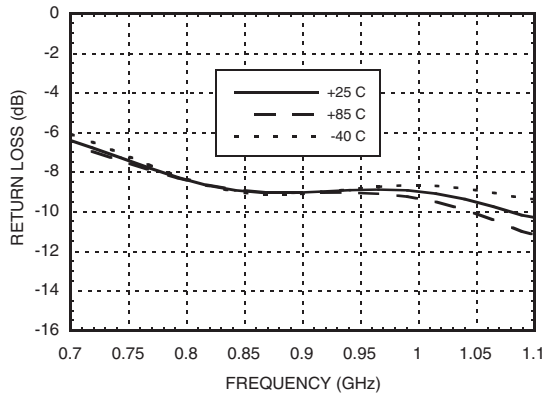

### Output Return Loss vs. Temperature @ 900 MHz

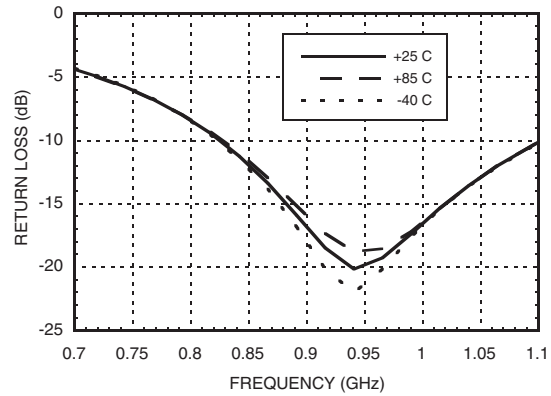

### P1dB vs. Temperature @ 900 MHz

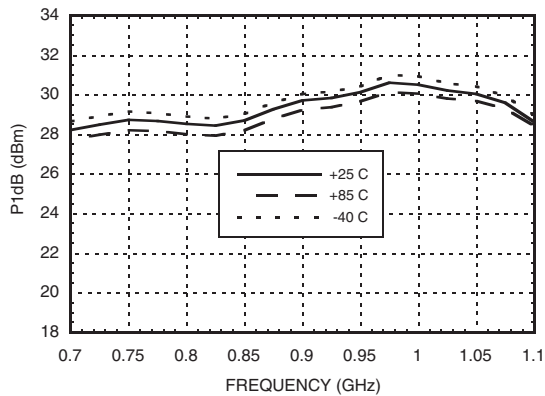

### Psat vs. Temperature @ 900 MHz

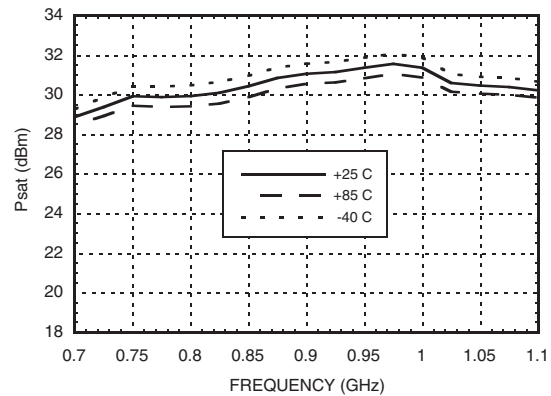

**Output IP3 vs. Temperature @ 900 MHz**

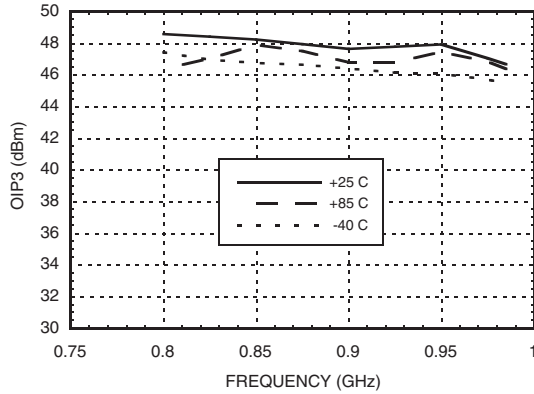

**Noise Figure vs. Temperature @ 900 MHz**

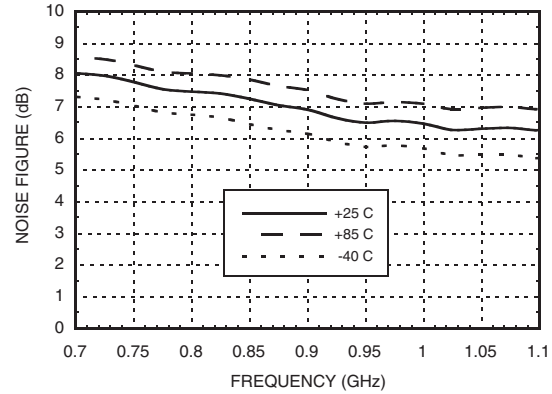

**Reverse Isolation vs. Temperature @ 900 MHz**

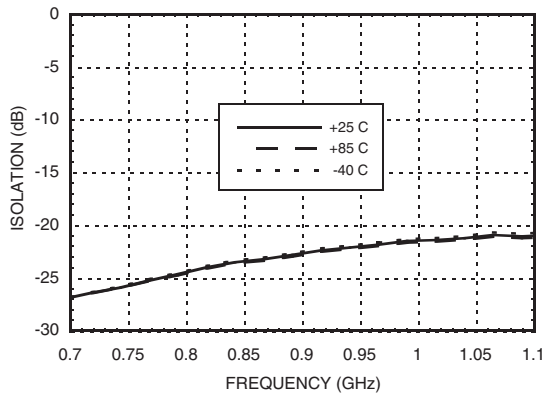

**Gain, Power & IP3 vs. Supply Voltage @ 900 MHz**

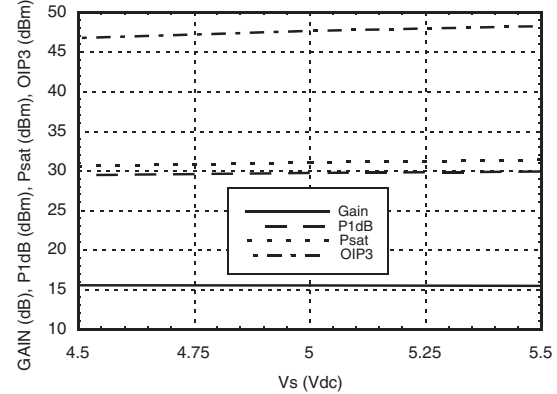

**Gain, Power & IP3 vs. Supply Current @ 900 MHz\***

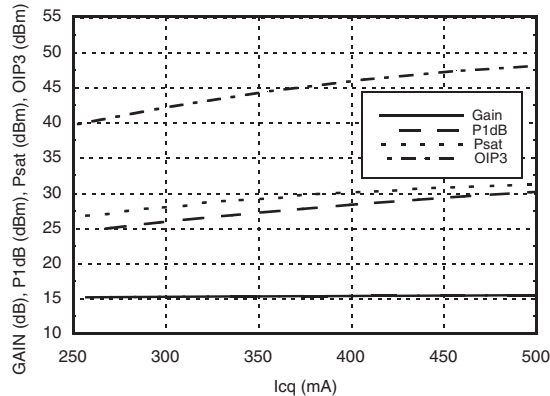

**ACPR vs. Supply Voltage @ 910 MHz CDMA IS95, 9 Channels Forward**

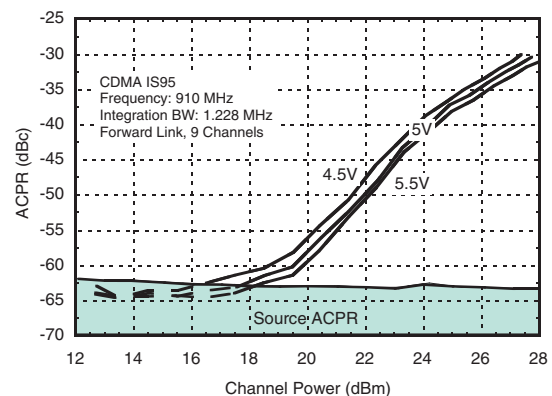

\* Icq is controlled by varying VPD.



### Broadband Gain & Return Loss @ 1900 MHz

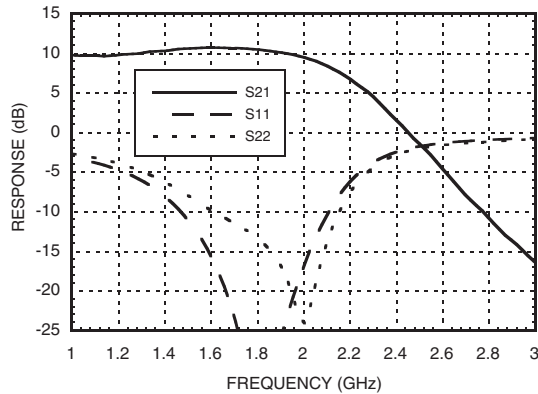

### Gain vs. Temperature @ 1900 MHz

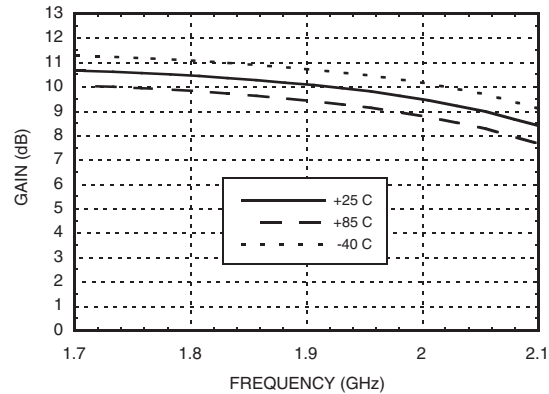

### Input Return Loss vs. Temperature @ 1900 MHz

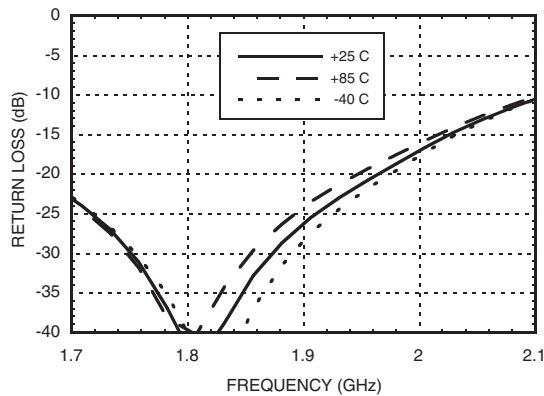

### Output Return Loss vs. Temperature @ 1900 MHz

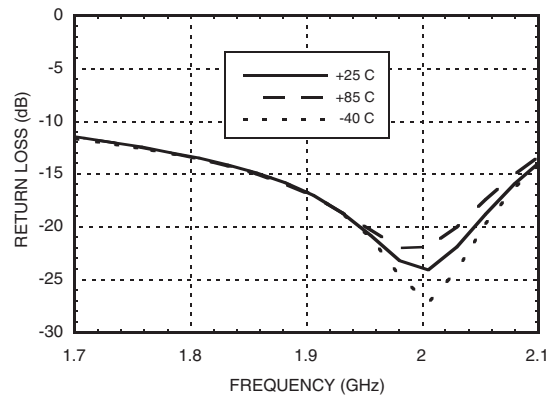

### P1dB vs. Temperature @ 1900 MHz

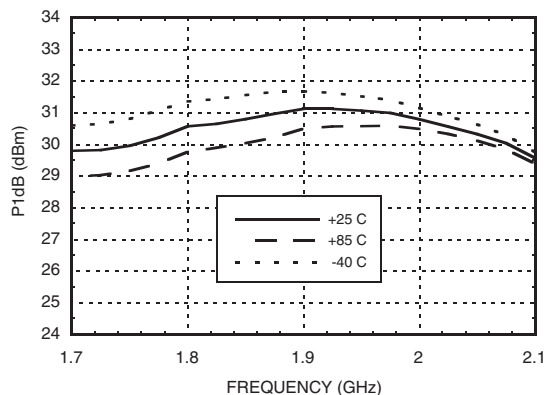

### Psat vs. Temperature @ 1900 MHz

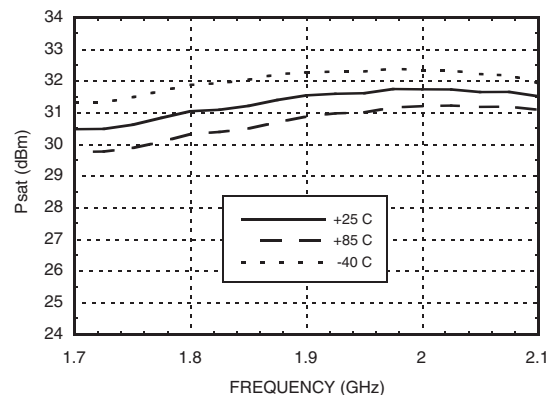

11

LINEAR & POWER AMPLIFIERS - SMT





# HMC452QS16G / 452QS16GE

## InGaP HBT 1 WATT POWER AMPLIFIER, 0.4 - 2.2 GHz

**Output IP3 vs. Temperature @ 1900 MHz**

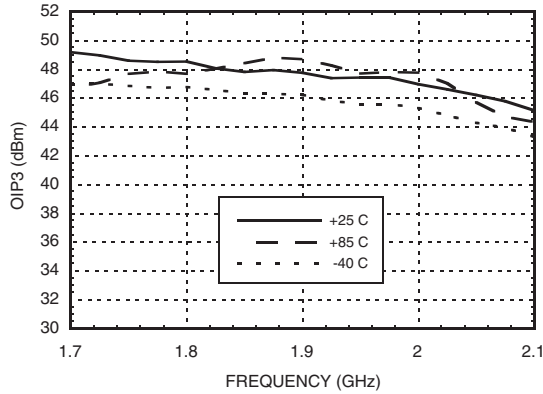

**Noise Figure vs. Temperature @ 1900 MHz**

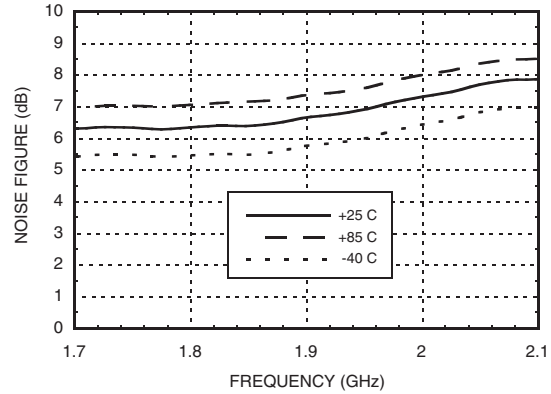

**Reverse Isolation vs. Temperature @ 1900 MHz**

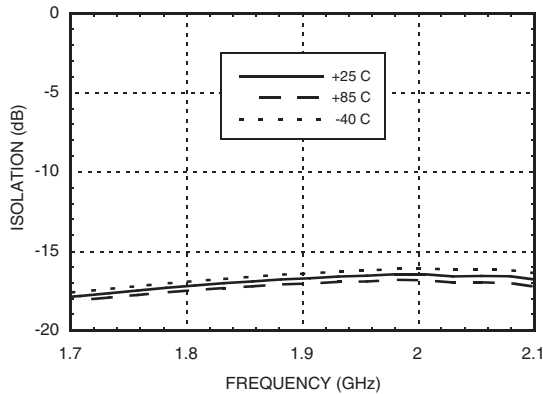

**Gain, Power & IP3 vs. Supply Voltage @ 1900 MHz**

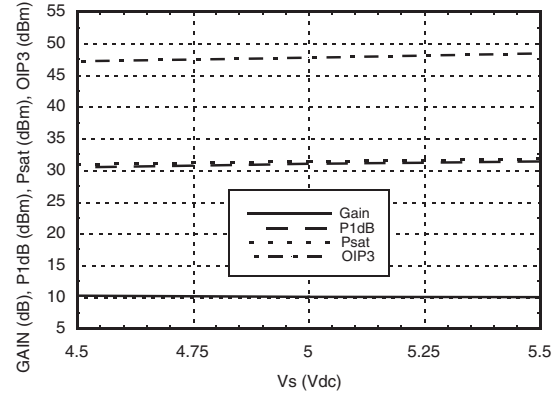

**Gain, Power & IP3 vs. Supply Current @ 1900 MHz\***

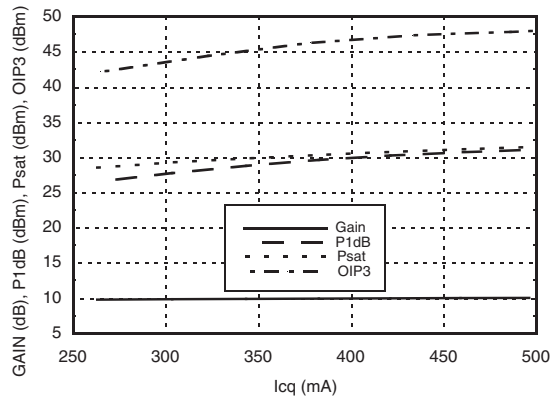

**ACPR vs. Supply Voltage @ 1960 MHz CDMA 2000, 9 Channels Forward**

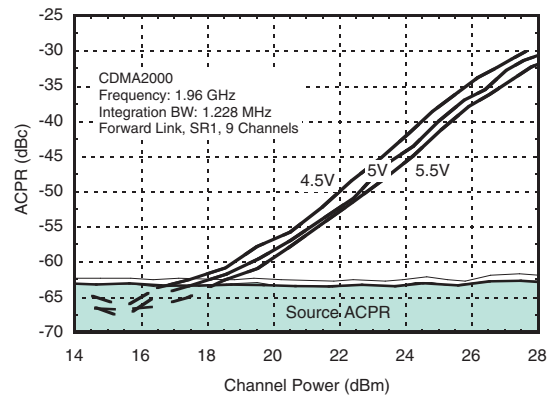

\* Icq is controlled by varying VPD.



### Broadband Gain & Return Loss @ 2100 MHz

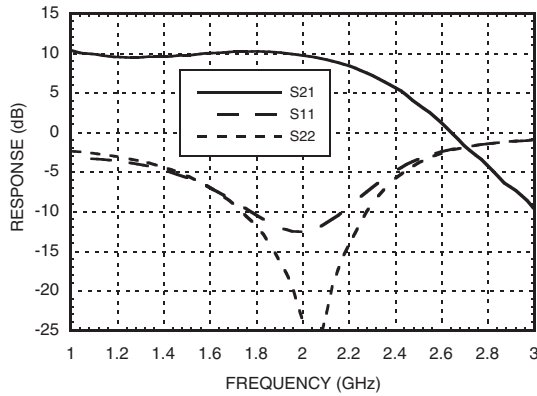

### Gain vs. Temperature @ 2100 MHz

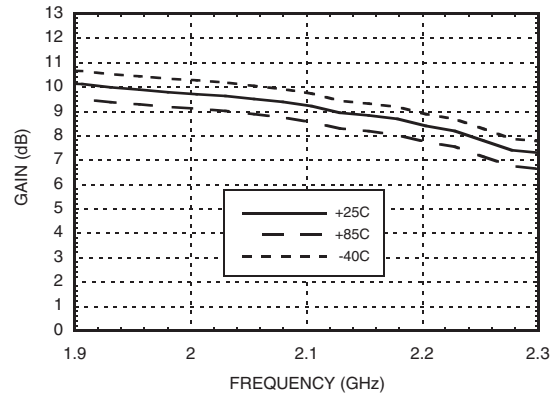

### Input Return Loss vs. Temperature @ 2100 MHz

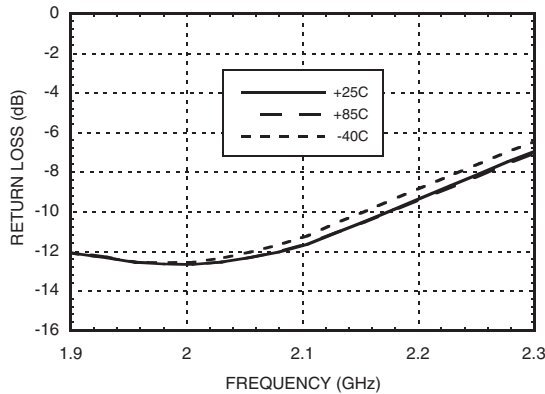

### Output Return Loss vs. Temperature @ 2100 MHz

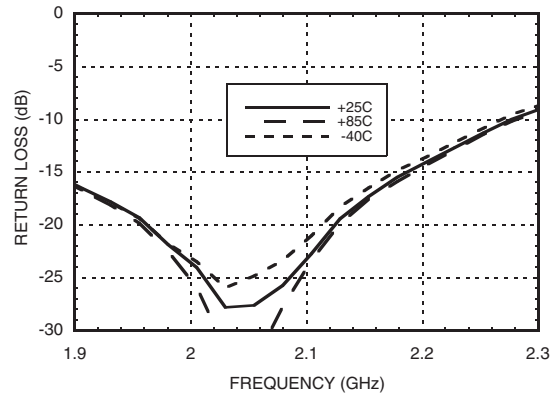

### P1dB vs. Temperature @ 2100 MHz

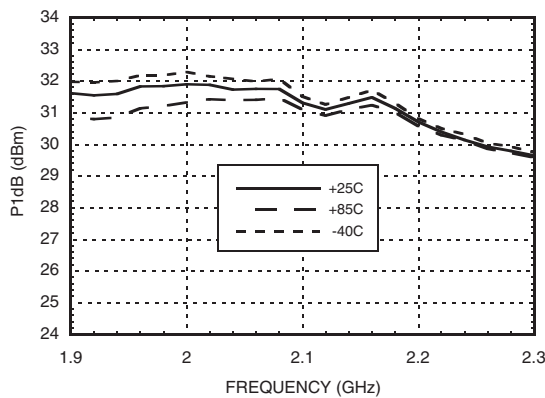

### Psat vs. Temperature @ 2100 MHz

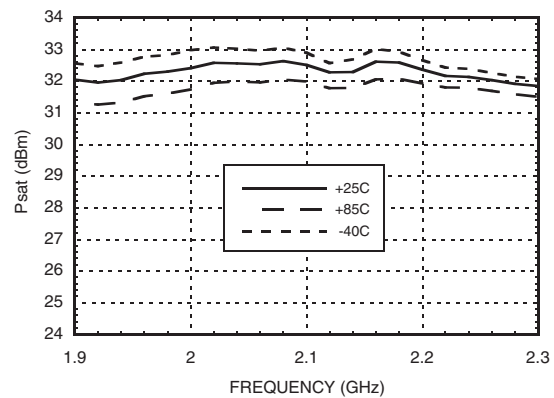

11

LINEAR & POWER AMPLIFIERS - SMT

**Output IP3 vs. Temperature @ 2100 MHz**

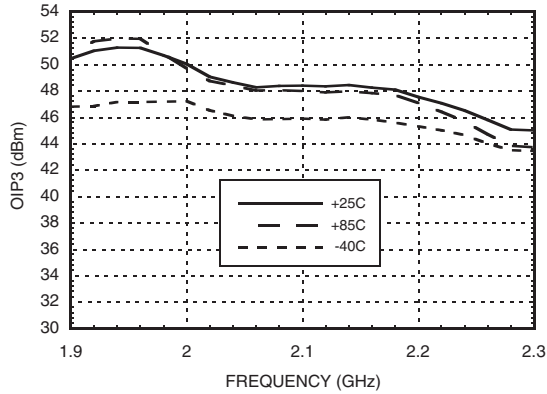

**Noise Figure vs. Temperature @ 2100 MHz**

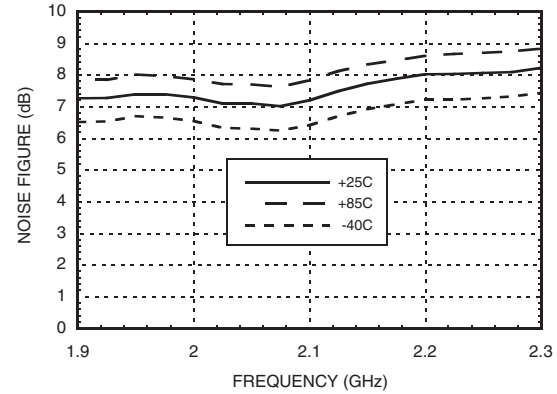

**Reverse Isolation vs. Temperature @ 2100 MHz**

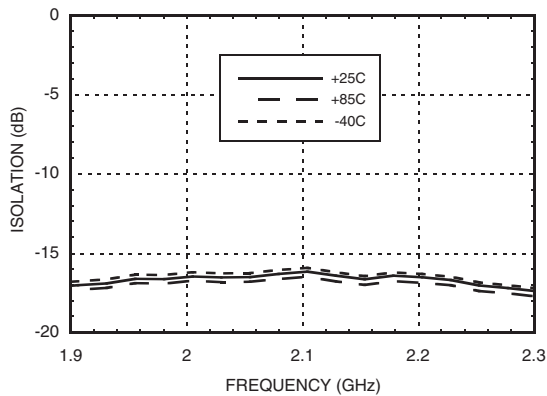

**Gain, Power & IP3 vs. Supply Voltage @ 2100 MHz**

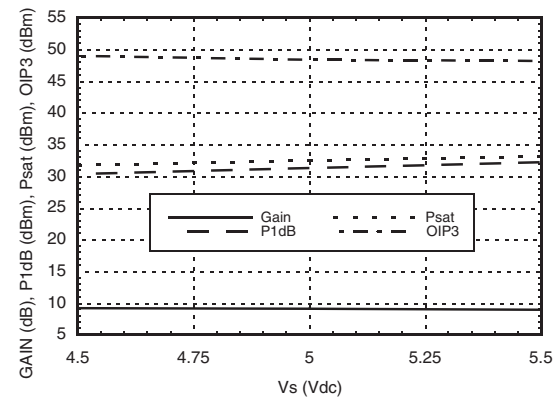

**Power Compression @ 2100 MHz**

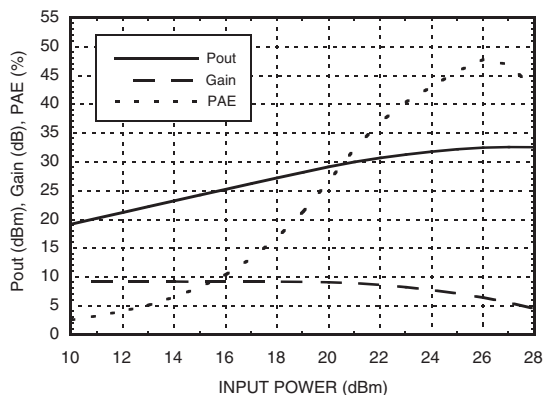

**ACPR vs. Supply Voltage @ 2140 MHz W-CDMA, 64 DPCH**

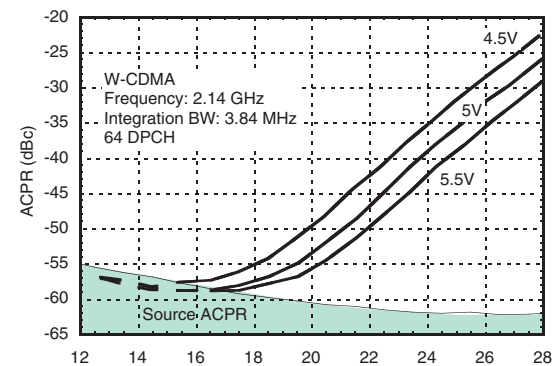

### Power Dissipation

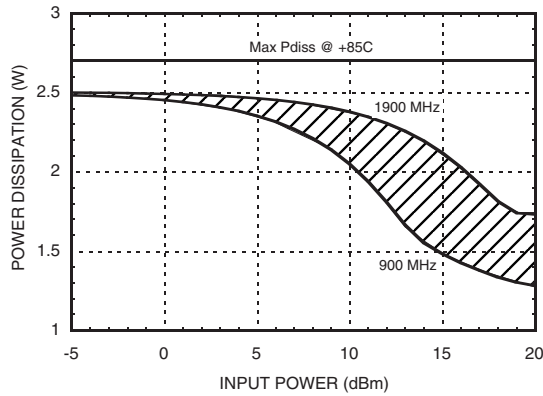

### Absolute Maximum Ratings

Collector Bias Voltage (Vcc)	+6.0 Vdc
Control Voltage (Vpd)	+5.3 Vdc
RF Input Power (RFIN)(Vs = Vpd = +5Vdc)	+31 dBm
Junction Temperature	150 °C
Continuous Pdiss (T = 85 °C) (derate 41.5 mW/°C above 85 °C)	2.7 W
Thermal Resistance (junction to ground paddle)	24.1 °C/W
Storage Temperature	-65 to +150 °C
Operating Temperature	-40 to +85 °C
ESD Sensitivity (HBM)	Class 1A



ELECTROSTATIC SENSITIVE DEVICE  
OBSERVE HANDLING PRECAUTIONS

### Outline Drawing

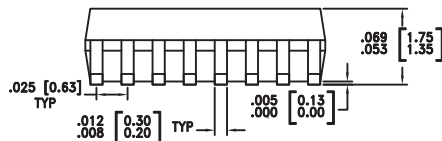
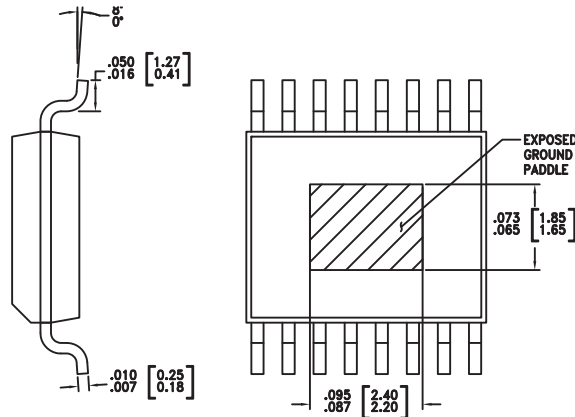
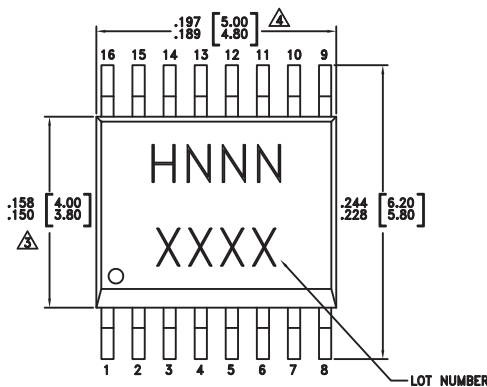

NOTES:

- LEADFRAME MATERIAL: COPPER ALLOY
- DIMENSIONS ARE IN INCHES [MILLIMETERS]
- DIMENSION DOES NOT INCLUDE MOLDFLASH OF 0.15mm PER SIDE.
- DIMENSION DOES NOT INCLUDE MOLDFLASH OF 0.25mm PER SIDE.
- ALL GROUND LEADS AND GROUND PADDLE MUST BE SOLDERED TO PCB RF GROUND.

### Package Information

Part Number	Package Body Material	Lead Finish	MSL Rating	Package Marking <sup>[3]</sup>
HMC452QS16G	Low Stress Injection Molded Plastic	Sn/Pb Solder	MSL1 <sup>[1]</sup>	H452 XXXX
HMC452QS16GE	RoHS-compliant Low Stress Injection Molded Plastic	100% matte Sn	MSL1 <sup>[2]</sup>	H452 XXXX

[1] Max peak reflow temperature of 235 °C

[2] Max peak reflow temperature of 260 °C

[3] 4-Digit lot number XXXX

For price, delivery, and to place orders, please contact Hittite Microwave Corporation:  
20 Alpha Road, Chelmsford, MA 01824 Phone: 978-250-3343 Fax: 978-250-3373  
Order On-line at [www.hittite.com](http://www.hittite.com)

### Pin Descriptions

Pin Number	Function	Description	Interface Schematic
1, 2, 4, 5, 7-10, 13-16	GND	These pins & package bottom must be connected to RF/DC ground.	
3	VPD	Power control pin. For maximum power, this pin should be connected to 5V. A higher voltage is not recommended. For lower idle current, this voltage can be reduced.	
6	RFIN	This pin is DC coupled. Off chip matching components are required. See Application Circuit herein.	
11, 12	RFOUT	RF output and DC Bias input for the output amplifier stage. Off chip matching components are required. See Application Circuit herein.	

### 400 MHz Application Circuit

This circuit was used to specify the performance for 400-410 MHz operation. Contact the HMC Applications Group for assistance in optimizing performance for your application.

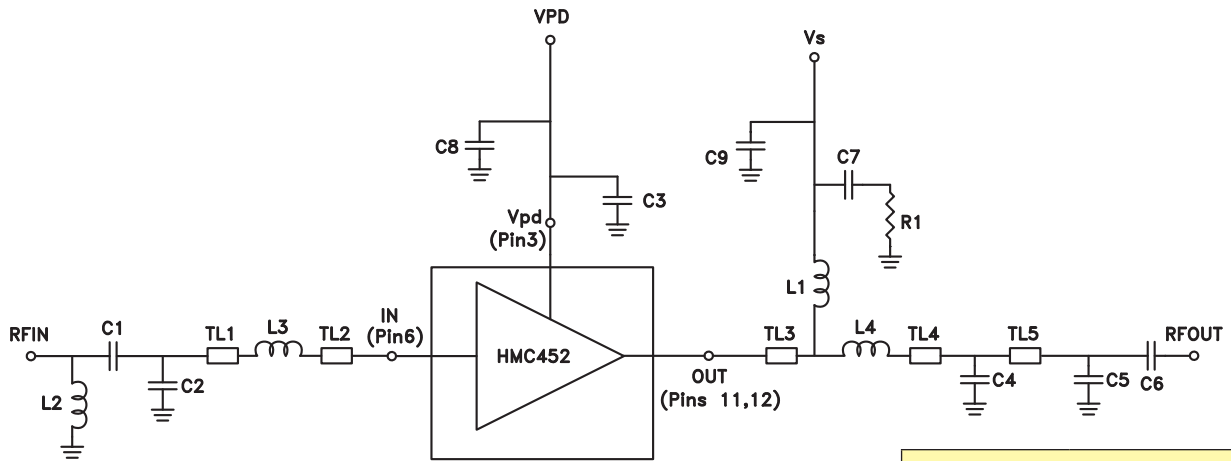

Recommended Component Values	
C1, C2	12 pF
C3, C7	100 pF
C4, C5	6.8 pF
C6	39 pF
C8, C9	2.2 μF
L1	47 nH
L2	40 nH
L3	4.7 nH
L4	5.6 nH
R1	5.1 Ohms

Note: C3 should be placed as close to pins as possible.

	TL1	TL2	TL3	TL4	TL5
Impedance	50 Ohm	50 Ohm	50 Ohm	50 Ohm	50 Ohm
Physical Length	0.11"	0.06"	0.12"	0.04"	0.16"
Electrical Length	3°	2°	3°	1°	4°
PCB Material: 10 mil Rogers 4350, Er = 3.48					

For price, delivery, and to place orders, please contact Hittite Microwave Corporation:  
 20 Alpha Road, Chelmsford, MA 01824 Phone: 978-250-3343 Fax: 978-250-3373  
 Order On-line at [www.hittite.com](http://www.hittite.com)

### 400 MHz Evaluation PCB

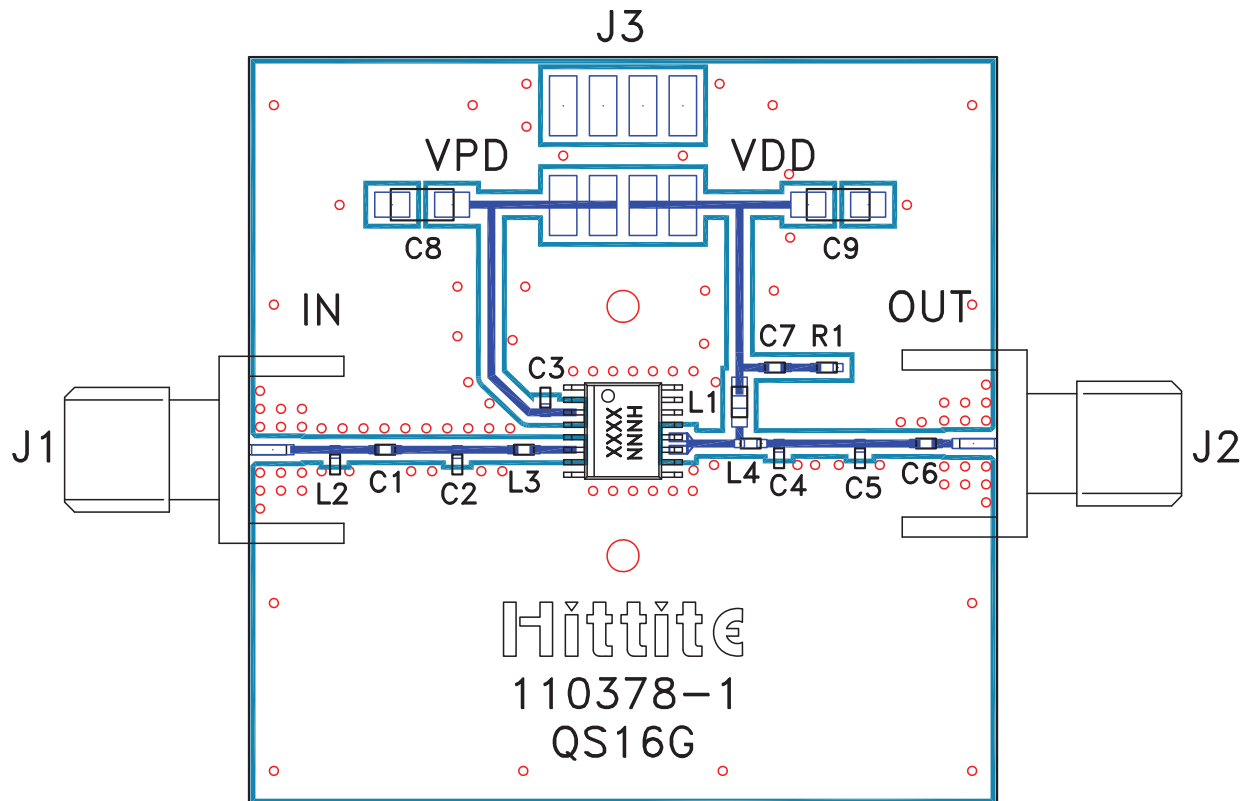

### List of Materials for Evaluation PCB 110380-400 [1]

Item	Description
J1 - J2	PCB Mount SMA Connector
J3	2 mm DC Header
C1, C2	12 pF Capacitor, 0402 Pkg.
C3, C7	100 pF Capacitor, 0402 Pkg.
C4, C5	6.8 pF Capacitor, 0402 Pkg.
C6	39 pF Capacitor, 0402 Pkg.
C8, C9	2.2 μF Capacitor, Tantalum
L1	47 nH Inductor, 0603 Pkg.
L2	40 nH Inductor, 0402 Pkg.
L3	4.7 nH Inductor, 0402 Pkg.
L4	5.6 nH Inductor, 0402 Pkg.
R1	5.1 Ohm Resistor, 0402 Pkg.
U1	HMC452QS16G / HMC452QS16GE Linear Amp
PCB [2]	110378 Evaluation PCB, 10 mils

[1] Reference this number when ordering complete evaluation PCB

[2] Circuit Board Material: Rogers 4350, Er = 3.48

The circuit board used in this application should use RF circuit design techniques. Signal lines should have 50 ohm impedance while the package ground leads and exposed paddle should be connected directly to the ground plane similar to that shown. A sufficient number of via holes should be used to connect the top and bottom ground planes. The evaluation board should be mounted to an appropriate heat sink. The evaluation circuit board shown is available from Hittite upon request.



### 470 MHz Application Circuit

This circuit was used to specify the performance for 450-496 MHz operation. Contact the HMC Applications Group for assistance in optimizing performance for your application.

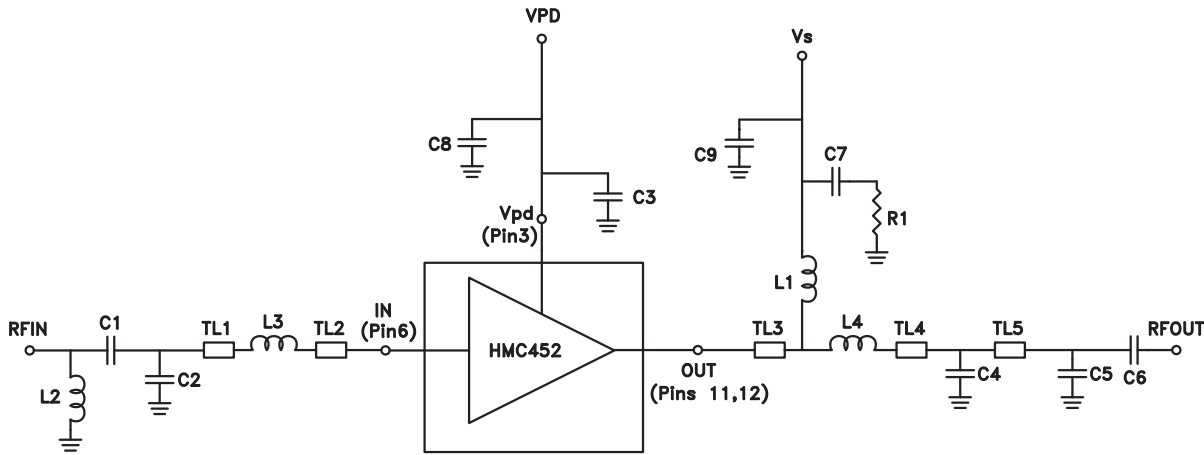

Note: C3 should be placed as close to pins as possible.

	TL1	TL2	TL3	TL4	TL5
Impedance	50 Ohm	50 Ohm	50 Ohm	50 Ohm	50 Ohm
Physical Length	0.11"	0.06"	0.12"	0.04"	0.16"
Electrical Length	3°	2°	3°	1°	4°
PCB Material: 10 mil Rogers 4350, Er = 3.48					

Recommended Component Values	
C1, C2	12 pF
C3, C7	100 pF
C4	6.8 pF
C5	5.6 pF
C6	39 pF
C8, C9	2.2 μF
L1	47 nH
L2	40 nH
L3	3.9 nH
L4	4.3 nH
R1	5.1 Ohms

### 470 MHz Evaluation PCB

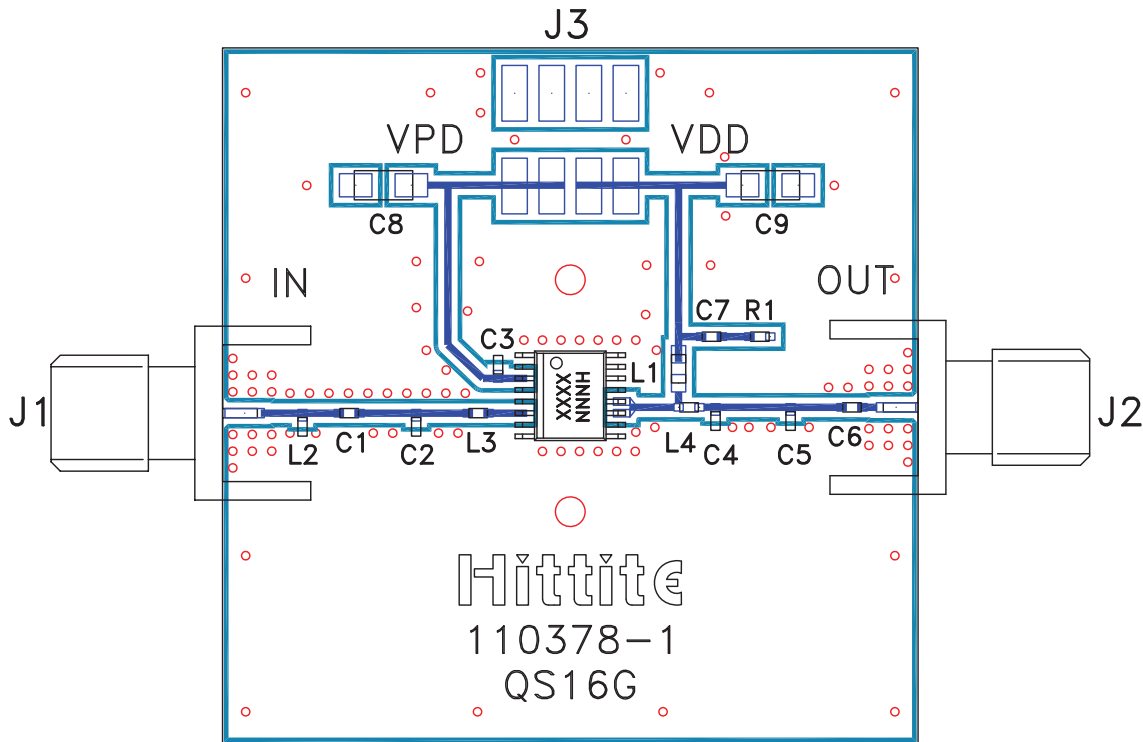

### List of Materials for Evaluation PCB 110381-470 [1]

Item	Description
J1 - J2	PCB Mount SMA Connector
J3	2 mm DC Header
C1, C2	12 pF Capacitor, 0402 Pkg.
C3, C7	100 pF Capacitor, 0402 Pkg.
C4	6.8 pF Capacitor, 0402 Pkg.
C5	5.6 pF Capacitor, 0402 Pkg.
C6	39 pF Capacitor, 0402 Pkg.
C8, C9	2.2 $\mu$ F Capacitor, Tantalum
L1	47 nH Inductor, 0603 Pkg.
L2	40 nH Inductor, 0402 Pkg.
L3	3.9 nH Inductor, 0402 Pkg.
L4	4.3 nH Inductor, 0402 Pkg.
R1	5.1 Ohm Resistor, 0402 Pkg.
U1	HMC452QS16G / HMC452QS16GE Linear Amp
PCB [2]	110378 Evaluation PCB, 10 mils

[1] Reference this number when ordering complete evaluation PCB

[2] Circuit Board Material: Rogers 4350, Er = 3.48

The circuit board used in this application should use RF circuit design techniques. Signal lines should have 50 ohm impedance while the package ground leads and exposed paddle should be connected directly to the ground plane similar to that shown. A sufficient number of via holes should be used to connect the top and bottom ground planes. The evaluation board should be mounted to an appropriate heat sink. The evaluation circuit board shown is available from Hittite upon request.





### 900 MHz Application Circuit

This circuit was used to specify the performance for 810-960 MHz operation. Contact the HMC Applications Group for assistance in optimizing performance for your application.

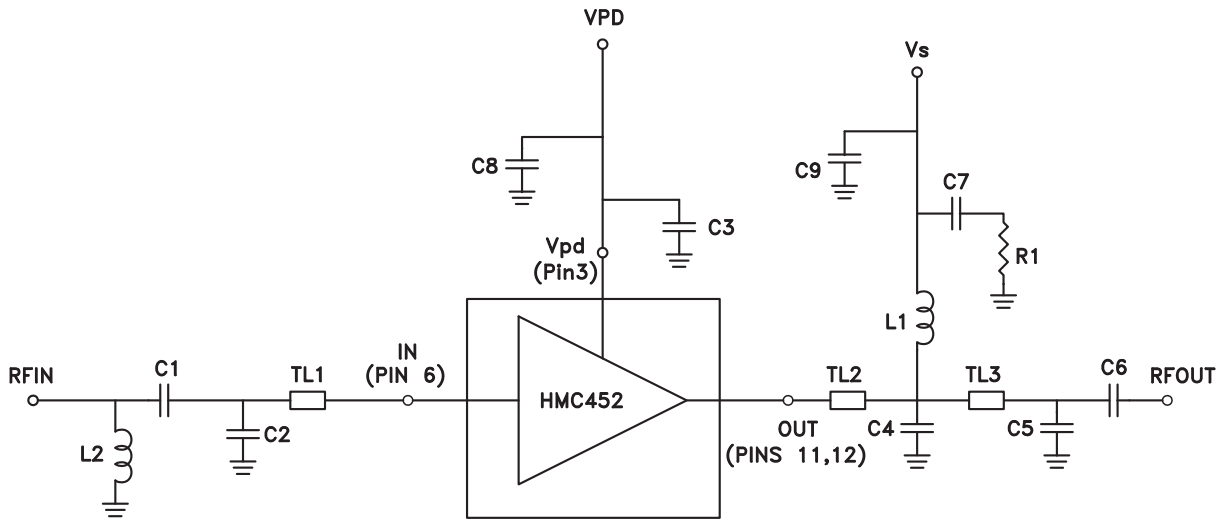

Note: C3 should be placed as close to pins as possible.

	TL1	TL2	TL3
Impedance	50 Ohm	50 Ohm	50 Ohm
Physical Length	0.21"	0.19"	0.23"
Electrical Length	11°	10°	12°
PCB Material: 10 mil Rogers 4350, Er = 3.48			

Recommended Component Values	
C1	10 pF
C2, C6	5.6 pF
C3, C7	100 pF
C4	2.2 pF
C5	5 pF
C8, C9	2.2 μF
L1, L2	20 nH
R1	5.6 Ohm

### 900 MHz Evaluation PCB

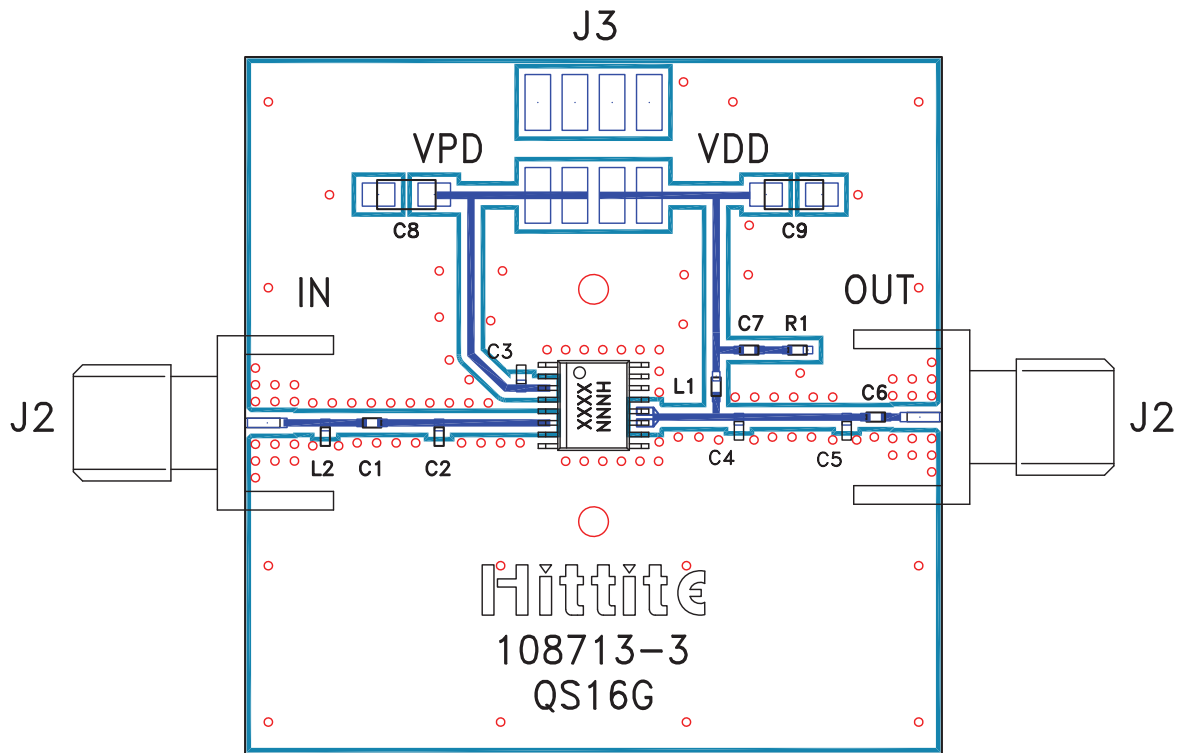

### List of Materials for Evaluation PCB 108715-900 [1]

Item	Description
J1 - J2	PCB Mount SMA Connector
J3	2 mm DC Header
C1	10 pF Capacitor, 0402 Pkg.
C2, C6	5.6 pF Capacitor, 0402 Pkg.
C3, C7	100 pF Capacitor, 0402 Pkg.
C4	2.2 pF Capacitor, 0402 Pkg.
C5	5 pF Capacitor, 0402 Pkg.
C8, C9	2.2 μF Capacitor, Tantalum
L1, L2	20 nH Inductor, 0402 Pkg.
R1	5.6 Ohm Resistor, 0402 Pkg.
U1	HMC452QS16G / HMC452QS16GE Linear Amp
PCB [2]	108713 Evaluation PCB, 10 mils

[1] Reference this number when ordering complete evaluation PCB

[2] Circuit Board Material: Rogers 4350, Er = 3.48

The circuit board used in this application should use RF circuit design techniques. Signal lines should have 50 ohm impedance while the package ground leads and exposed paddle should be connected directly to the ground plane similar to that shown. A sufficient number of via holes should be used to connect the top and bottom ground planes. The evaluation board should be mounted to an appropriate heat sink. The evaluation circuit board shown is available from Hittite upon request.

### 1900 MHz Application Circuit

This circuit was used to specify the performance for 1710-1990 MHz operation. Contact the HMC Applications Group for assistance in optimizing performance for your application.

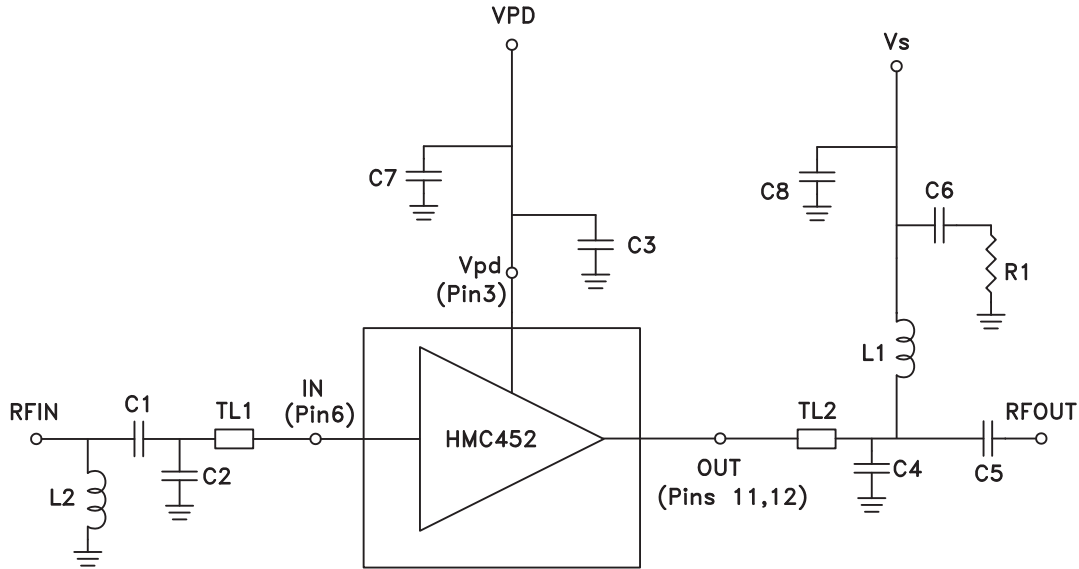

Note: C2, C3 and C4 should be placed as close to pins as possible.

	TL1	TL2
Impedance	50 Ohm	50 Ohm
Physical Length	0.04"	0.08"
Electrical Length	4°	9°
PCB Material: 10 mil Rogers 4350, Er = 3.48		

Recommended Component Values	
C1	2.7 pF
C2	2 pF
C3, C5, C6	100 pF
C4	3.3 pF
C7, C8	2.2 μF
L1, L2	20 nH
R1	5.6 Ohms

### 1900 MHz Evaluation PCB

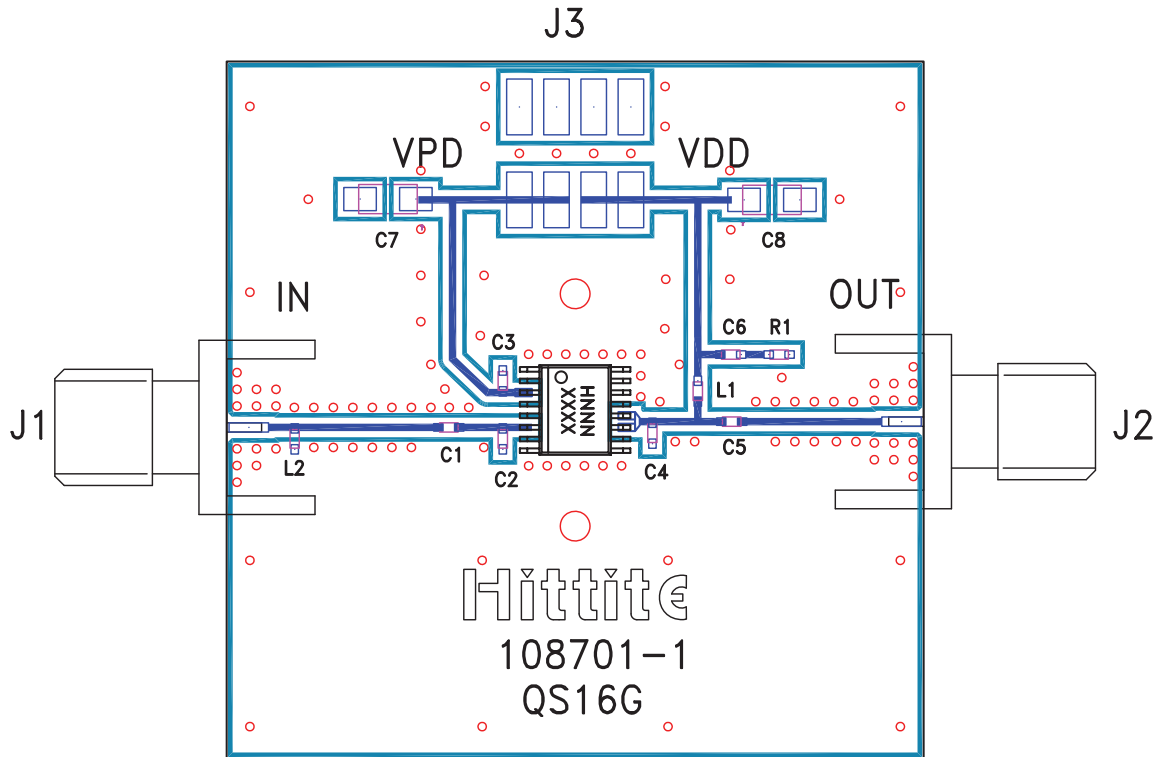

### List of Materials for Evaluation PCB 108703-1900 <sup>[1]</sup>

Item	Description
J1 - J2	PCB Mount SMA Connector
J3	2 mm DC Header
C1	2.7 pF Capacitor, 0402 Pkg.
C2	2 pF Capacitor, 0402 Pkg.
C3, C5, C6	100 pF Capacitor, 0402 Pkg.
C4	3.3 pF Capacitor, 0402 Pkg.
C7, C8	2.2 $\mu$ F Capacitor, Tantalum
L1, L2	20 nH Inductor, 0402 Pkg.
R1	5.6 Ohm Resistor, 0402 Pkg.
U1	HMC452QS16G / HMC452QS16GE Linear Amp
PCB <sup>[2]</sup>	108701 Evaluation PCB, 10 mils

[1] Reference this number when ordering complete evaluation PCB

[2] Circuit Board Material: Rogers 4350, Er = 3.48

The circuit board used in this application should use RF circuit design techniques. Signal lines should have 50 ohm impedance while the package ground leads and exposed paddle should be connected directly to the ground plane similar to that shown. A sufficient number of via holes should be used to connect the top and bottom ground planes. The evaluation board should be mounted to an appropriate heat sink. The evaluation circuit board shown is available from Hittite upon request.

### 2100 MHz Application Circuit

This circuit was used to specify the performance for 2010-2170 MHz operation. Contact the HMC Applications Group for assistance in optimizing performance for your application.

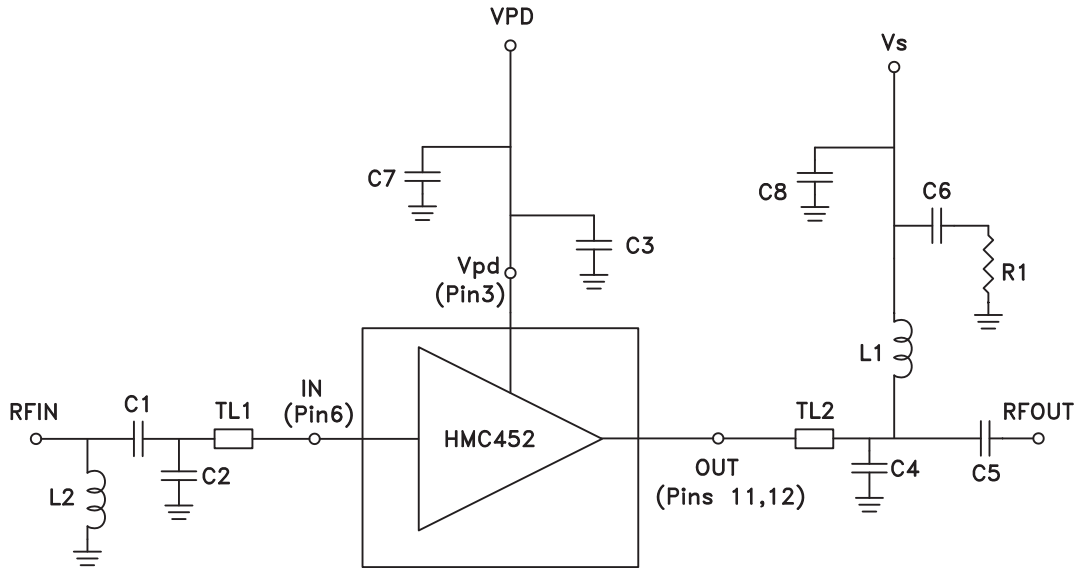

Note: C2, C3 and C4 should be placed as close to pins as possible.

	TL1	TL2
Impedance	50 Ohm	50 Ohm
Physical Length	0.04"	0.08"
Electrical Length	5°	10°
PCB Material: 10 mil Rogers 4350, Er = 3.48		

Recommended Component Values	
C1	4.7 pF
C2	2 pF
C3, C6	100 pF
C4	3.3 pF
C5	15 pF
C7, C8	2.2 μF
L1	12 nH
L2	10 nH
R1	5.1 Ohms

### 2100 MHz Evaluation PCB

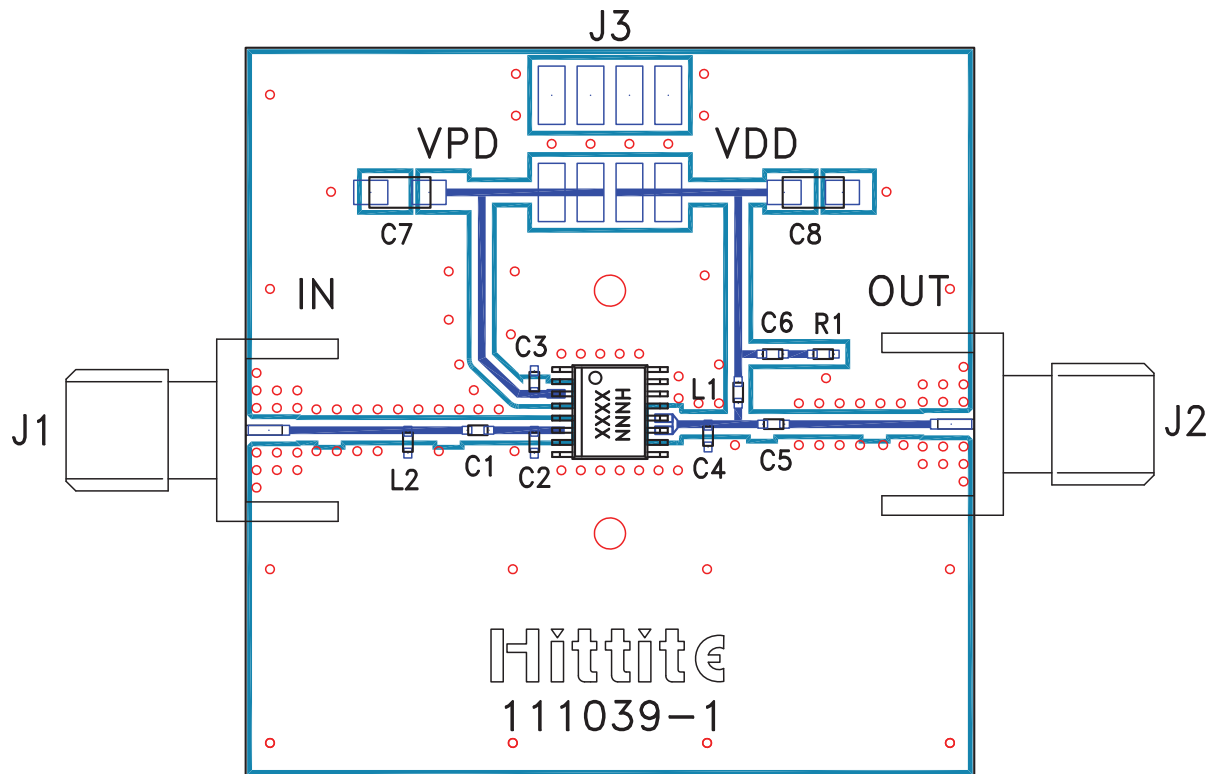

### List of Materials for Evaluation PCB 111041-2100 [1]

Item	Description
J1 - J2	PCB Mount SMA Connector
J3	2 mm DC Header
C1	4.7 pF Capacitor, 0402 Pkg.
C2	2 pF Capacitor, 0402 Pkg.
C3, C6	100 pF Capacitor, 0402 Pkg.
C4	3.3 pF Capacitor, 0402 Pkg.
C5	15 pF Capacitor, 0402 Pkg.
C7, C8	2.2 $\mu$ F Capacitor, Tantalum
L1	12 nH Inductor, 0402 Pkg.
L2	10 nH Inductor, 0402 Pkg.
R1	5.1 Ohm Resistor, 0402 Pkg.
U1	HMC452QS16G / HMC452QS16GE Linear Amp
PCB [2]	111039 Evaluation PCB, 10 mils

[1] Reference this number when ordering complete evaluation PCB

[2] Circuit Board Material: Rogers 4350, Er = 3.48

The circuit board used in this application should use RF circuit design techniques. Signal lines should have 50 ohm impedance while the package ground leads and exposed paddle should be connected directly to the ground plane similar to that shown. A sufficient number of via holes should be used to connect the top and bottom ground planes. The evaluation board should be mounted to an appropriate heat sink. The evaluation circuit board shown is available from Hittite upon request.