

## IGBT SIP MODULE

Fast IGBT

### Features

- Fully isolated printed circuit board mount package
- Switching-loss rating includes all "tail" losses
- HEXFRED™ soft ultrafast diodes
- Optimized for medium operating (1 to 10 kHz)  
See Fig. 1 for Current vs. Frequency curve

### Product Summary

#### Output Current in a Typical 5.0 kHz Motor Drive

18 A<sub>RMS</sub> per phase (4.6 kW total) with T<sub>C</sub> = 90°C, T<sub>J</sub> = 125°C, Supply Voltage 360Vdc,  
Power Factor 0.8, Modulation Depth 115% (See Figure 1)

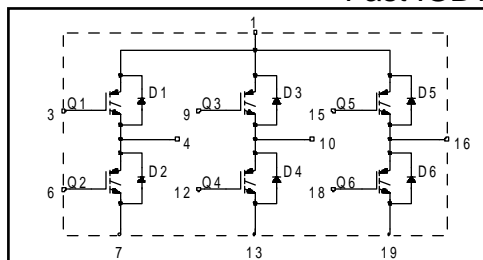

### Description

The IGBT technology is the key to International Rectifier's advanced line of IMS (Insulated Metal Substrate) Power Modules. These modules are more efficient than comparable bipolar transistor modules, while at the same time having the simpler gate-drive requirements of the familiar power MOSFET. This superior technology has now been coupled to a state of the art materials system that maximizes power throughput with low thermal resistance. This package is highly suited to motor drive applications and where space is at a premium.

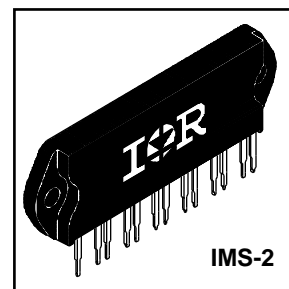

### Absolute Maximum Ratings

	Parameter	Max.	Units
V <sub>CES</sub>	Collector-to-Emitter Voltage	600	V
I <sub>C</sub> @ T <sub>C</sub> = 25°C	Continuous Collector Current, each IGBT	27	A
I <sub>C</sub> @ T <sub>C</sub> = 100°C	Continuous Collector Current, each IGBT	15	
I <sub>CM</sub>	Pulsed Collector Current ①	80	
I <sub>LM</sub>	Clamped Inductive Load Current ②	80	
I <sub>F</sub> @ T <sub>C</sub> = 100°C	Diode Continuous Forward Current	9.3	
I <sub>FM</sub>	Diode Maximum Forward Current	80	
V <sub>GE</sub>	Gate-to-Emitter Voltage	±20	V
V <sub>ISOL</sub>	Isolation Voltage, any terminal to case, 1 minute	2500	V <sub>RMS</sub>
P <sub>D</sub> @ T <sub>C</sub> = 25°C	Maximum Power Dissipation, each IGBT	63	W
P <sub>D</sub> @ T <sub>C</sub> = 100°C	Maximum Power Dissipation, each IGBT	25	
T <sub>J</sub> T <sub>STG</sub>	Operating Junction and Storage Temperature Range	-40 to +150	°C
	Soldering Temperature, for 10 sec.	300 (0.063 in. (1.6mm) from case)	
	Mounting torque, 6-32 or M3 screw.	5-7 lbf•in (0.55-0.8 N•m)	

### Thermal Resistance

	Parameter	Typ.	Max.	Units
R <sub>θJC</sub> (IGBT)	Junction-to-Case, each IGBT, one IGBT in conduction	—	2.0	°C/W
R <sub>θJC</sub> (DIODE)	Junction-to-Case, each diode, one diode in conduction	—	3.0	
R <sub>θCS</sub> (MODULE)	Case-to-Sink, flat, greased surface	0.10	—	
Wt	Weight of module	20 (0.7)	—	g (oz)

## Electrical Characteristics @ T<sub>J</sub> = 25°C (unless otherwise specified)

	Parameter	Min.	Typ.	Max.	Units	Conditions
V <sub>(BR)CES</sub>	Collector-to-Emitter Breakdown Voltage <sup>③</sup>	600	—	—	V	V <sub>GE</sub> = 0V, I <sub>C</sub> = 250μA
ΔV <sub>(BR)CES/ΔT<sub>J</sub></sub>	Temperature Coeff. of Breakdown Voltage	—	0.69	—	V/°C	V <sub>GE</sub> = 0V, I <sub>C</sub> = 1.0mA
V <sub>CE(on)</sub>	Collector-to-Emitter Saturation Voltage	—	1.35	1.5	V	I <sub>C</sub> = 15A V <sub>GE</sub> = 15V
		—	1.60	—		I <sub>C</sub> = 27A
		—	1.35	—		I <sub>C</sub> = 15A, T <sub>J</sub> = 150°C
V <sub>GE(th)</sub>	Gate Threshold Voltage	3.0	—	6.0		V <sub>CE</sub> = V <sub>GE</sub> , I <sub>C</sub> = 250μA
ΔV <sub>GE(th)/ΔT<sub>J</sub></sub>	Temperature Coeff. of Threshold Voltage	—	-12	—	mV/°C	V <sub>CE</sub> = V <sub>GE</sub> , I <sub>C</sub> = 250μA
g <sub>fe</sub>	Forward Transconductance <sup>④</sup>	9.2	12	—	S	V <sub>CE</sub> = 100V, I <sub>C</sub> = 27A
I <sub>CES</sub>	Zero Gate Voltage Collector Current	—	—	250	μA	V <sub>GE</sub> = 0V, V <sub>CE</sub> = 600V
		—	—	2500		V <sub>GE</sub> = 0V, V <sub>CE</sub> = 600V, T <sub>J</sub> = 150°C
V <sub>FM</sub>	Diode Forward Voltage Drop	—	1.3	1.7	V	I <sub>C</sub> = 15A
		—	1.2	1.6		I <sub>C</sub> = 15A, T <sub>J</sub> = 150°C
I <sub>GES</sub>	Gate-to-Emitter Leakage Current	—	—	±100	nA	V <sub>GE</sub> = ±20V

## Switching Characteristics @ T<sub>J</sub> = 25°C (unless otherwise specified)

	Parameter	Min.	Typ.	Max.	Units	Conditions
Q <sub>g</sub>	Total Gate Charge (turn-on)	—	100	160	nC	I <sub>C</sub> = 15A
Q <sub>ge</sub>	Gate - Emitter Charge (turn-on)	—	15	23		V <sub>CC</sub> = 400V
Q <sub>gc</sub>	Gate - Collector Charge (turn-on)	—	37	56		V <sub>GE</sub> = 15V See Fig. 8
t <sub>d(on)</sub>	Turn-On Delay Time	—	42	—	ns	T <sub>J</sub> = 25°C
t <sub>r</sub>	Rise Time	—	18	—		I <sub>C</sub> = 15A, V <sub>CC</sub> = 480V
t <sub>d(off)</sub>	Turn-Off Delay Time	—	220	330		V <sub>GE</sub> = 15V, R <sub>G</sub> = 10Ω
t <sub>f</sub>	Fall Time	—	160	240		Energy losses include "tail" and diode reverse recovery.
E <sub>on</sub>	Turn-On Switching Loss	—	0.46	—	mJ	See Fig. 9, 10, 11, 18
E <sub>off</sub>	Turn-Off Switching Loss	—	0.86	—		
E <sub>ts</sub>	Total Switching Loss	—	1.32	1.8		
t <sub>d(on)</sub>	Turn-On Delay Time	—	39	—	ns	T <sub>J</sub> = 150°C, See Fig. 9, 10, 11, 18
t <sub>r</sub>	Rise Time	—	19	—		I <sub>C</sub> = 15A, V <sub>CC</sub> = 480V
t <sub>d(off)</sub>	Turn-Off Delay Time	—	410	—		V <sub>GE</sub> = 15V, R <sub>G</sub> = 10Ω
t <sub>f</sub>	Fall Time	—	290	—		Energy losses include "tail" and diode reverse recovery.
C <sub>ies</sub>	Input Capacitance	—	2200	—	pF	V <sub>GE</sub> = 0V
C <sub>oes</sub>	Output Capacitance	—	140	—		V <sub>CC</sub> = 30V
C <sub>res</sub>	Reverse Transfer Capacitance	—	29	—		f = 1.0MHz
t <sub>rr</sub>	Diode Reverse Recovery Time	—	42	60	ns	T <sub>J</sub> = 25°C See Fig. 14
		—	74	120		T <sub>J</sub> = 125°C
I <sub>rr</sub>	Diode Peak Reverse Recovery Charge	—	4.0	6.0	A	T <sub>J</sub> = 25°C See Fig. 15
		—	6.5	10		T <sub>J</sub> = 125°C
Q <sub>rr</sub>	Diode Reverse Recovery Charge	—	80	180	nC	T <sub>J</sub> = 25°C See Fig. 16
		—	220	600		T <sub>J</sub> = 125°C
di <sub>(rec)M/dt</sub>	Diode Peak Rate of Fall of Recovery During t <sub>b</sub>	—	188	—	A/μs	T <sub>J</sub> = 25°C See Fig. 17
		—	160	—		T <sub>J</sub> = 125°C

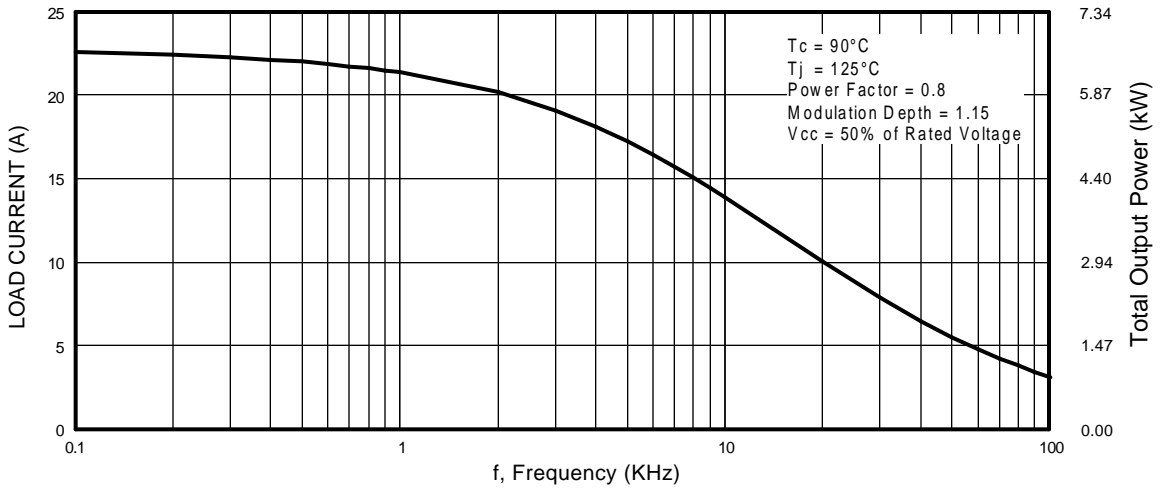

**Fig. 1 - Typical Load Current vs. Frequency**  
(Load Current =  $I_{RMS}$  of fundamental)

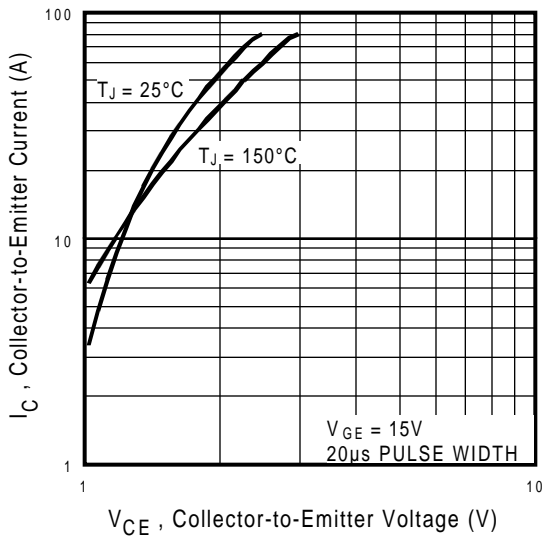

**Fig. 2 - Typical Output Characteristics**

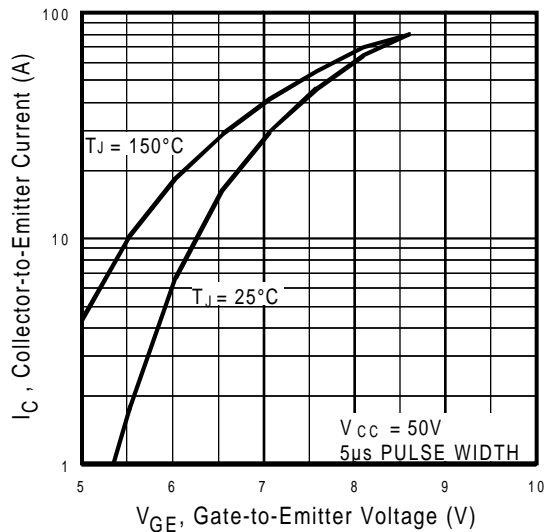

**Fig. 3 - Typical Transfer Characteristics**

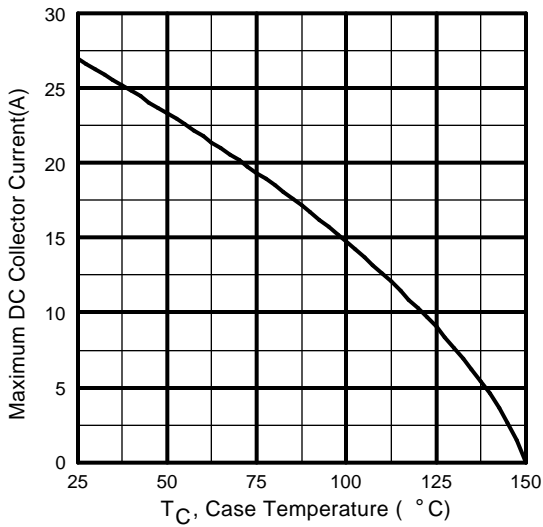

**Fig. 4** - Maximum Collector Current vs. Case Temperature

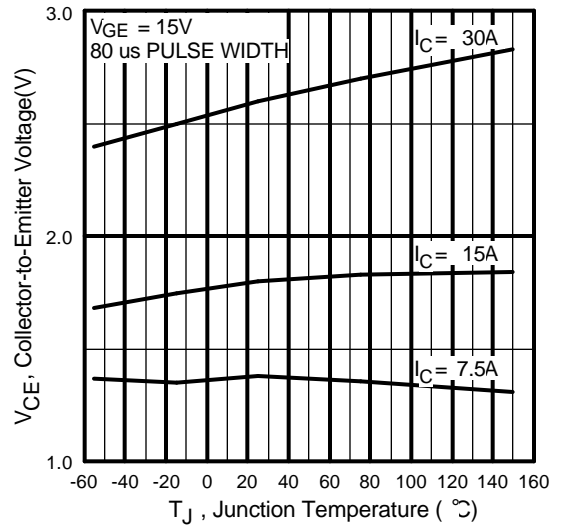

**Fig. 5** - Typical Collector-to-Emitter Voltage vs. Junction Temperature

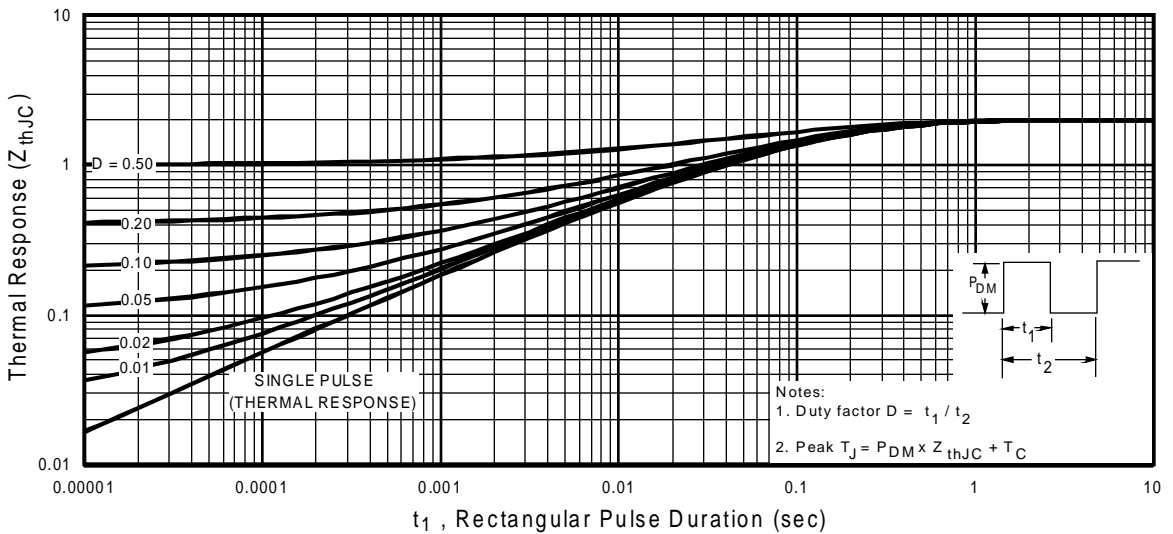

**Fig. 6** - Maximum Effective Transient Thermal Impedance, Junction-to-Case

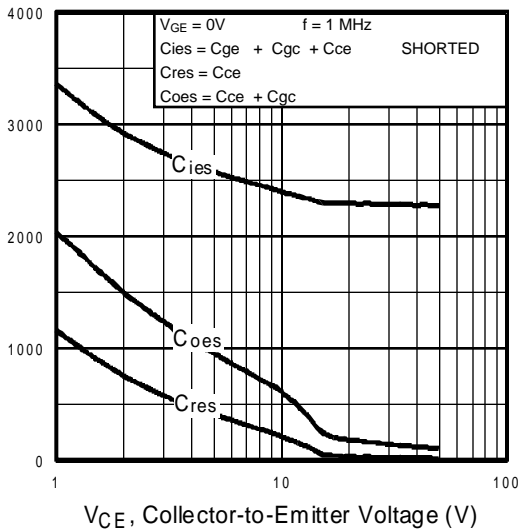

**Fig. 7** - Typical Capacitance vs. Collector-to-Emitter Voltage

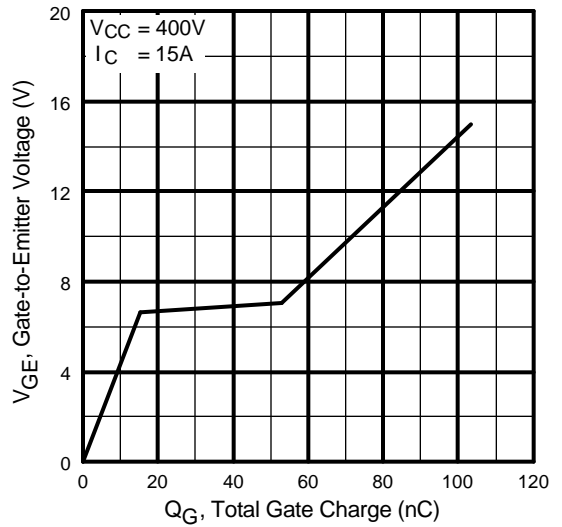

**Fig. 8** - Typical Gate Charge vs. Gate-to-Emitter Voltage

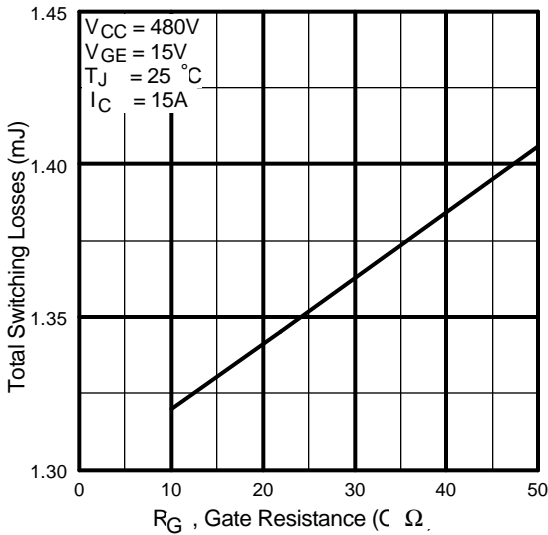

**Fig. 9** - Typical Switching Losses vs. Gate Resistance

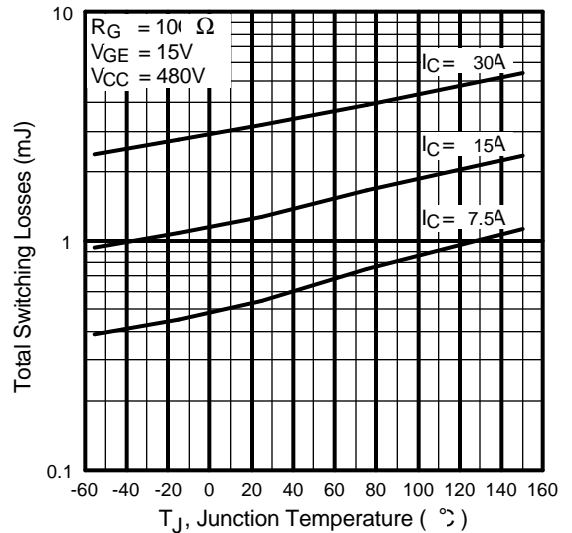

**Fig. 10** - Typical Switching Losses vs. Junction Temperature

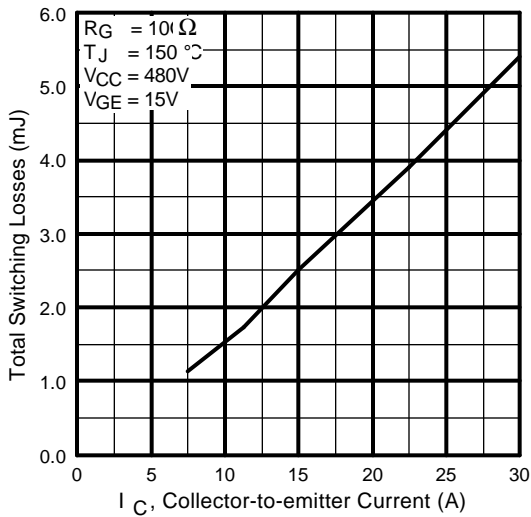

**Fig. 11** - Typical Switching Losses vs. Collector-to-emitter Current

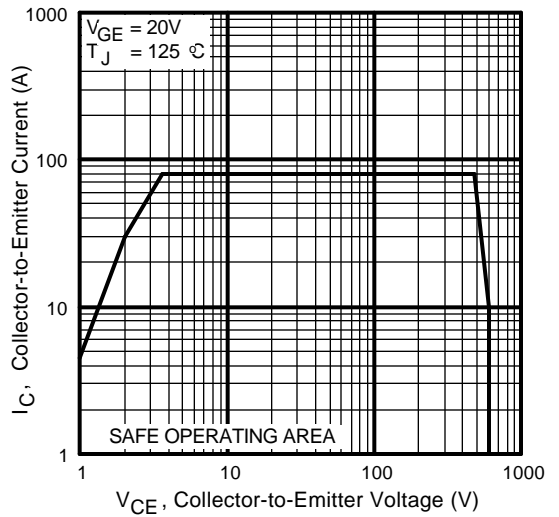

**Fig. 12** - Turn-Off SOA

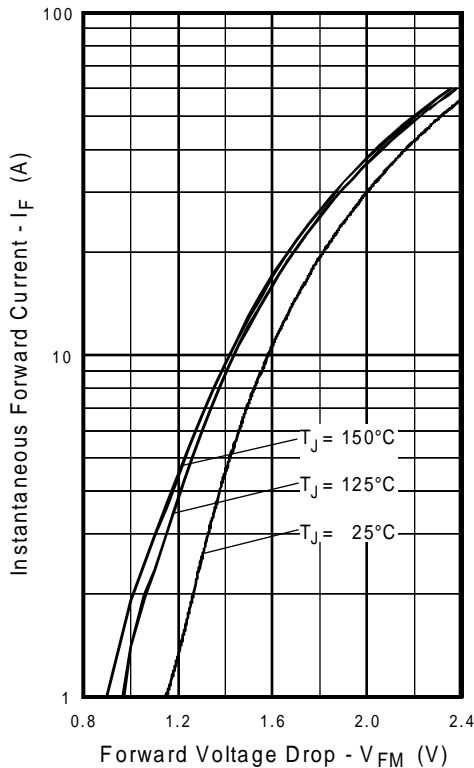

**Fig. 13** - Maximum Forward Voltage Drop vs. Instantaneous Forward Current

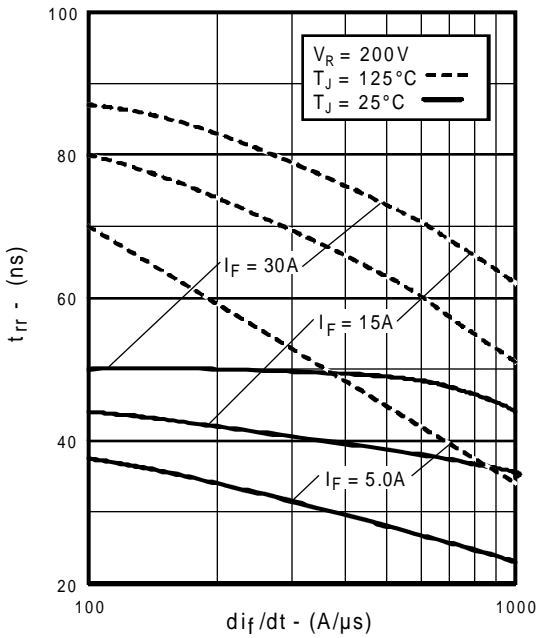

Fig. 14 - Typical Reverse Recovery vs.  $di_f/dt$

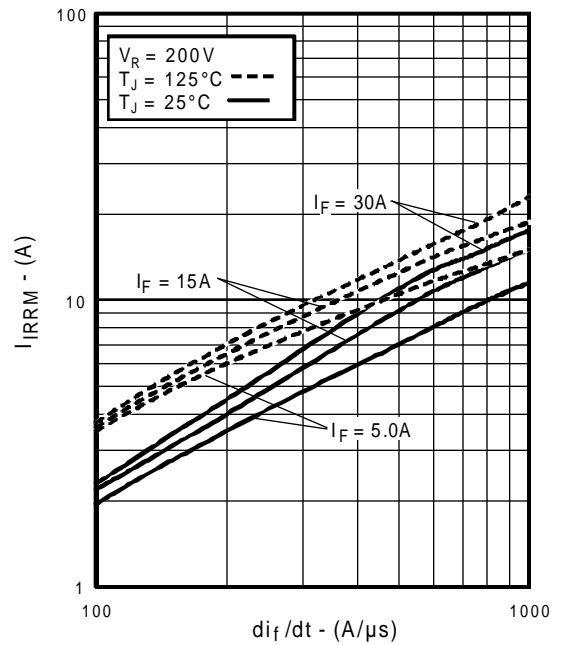

Fig. 15 - Typical Recovery Current vs.  $di_f/dt$

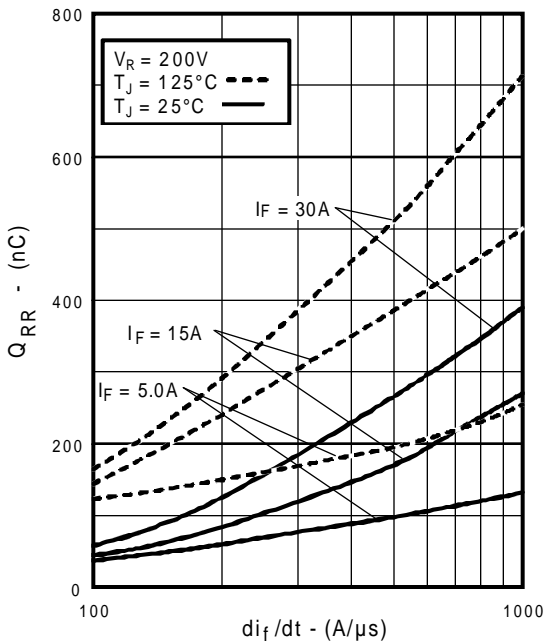

Fig. 16 - Typical Stored Charge vs.  $di_f/dt$

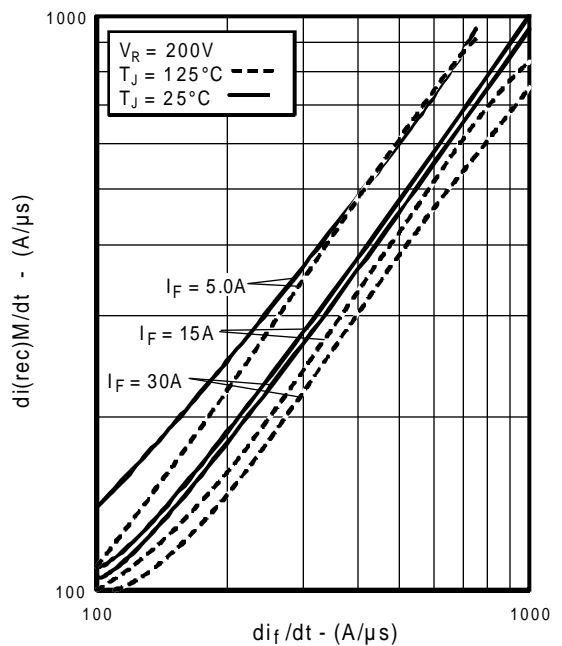
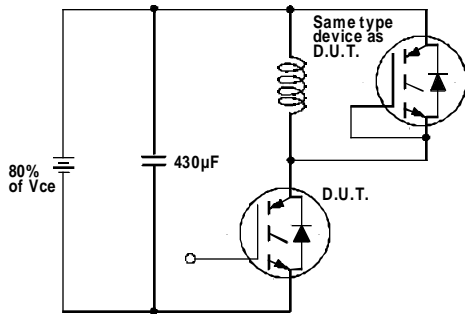
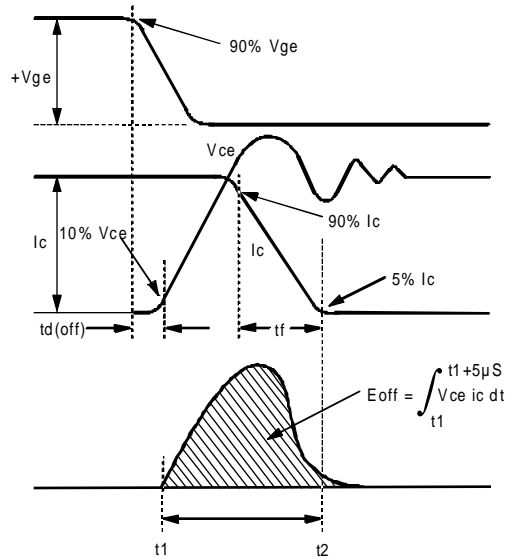

Fig. 17 - Typical  $di_{(rec)M}/dt$  vs.  $di_f/dt$



**Fig. 18a** - Test Circuit for Measurement of  $I_{LM}$ ,  $E_{on}$ ,  $E_{off}(\text{diode})$ ,  $t_{rr}$ ,  $Q_{rr}$ ,  $I_{rr}$ ,  $t_{d(on)}$ ,  $t_r$ ,  $t_{d(off)}$ ,  $t_f$



**Fig. 18b** - Test Waveforms for Circuit of Fig. 18a, Defining  $E_{off}$ ,  $t_{d(off)}$ ,  $t_f$

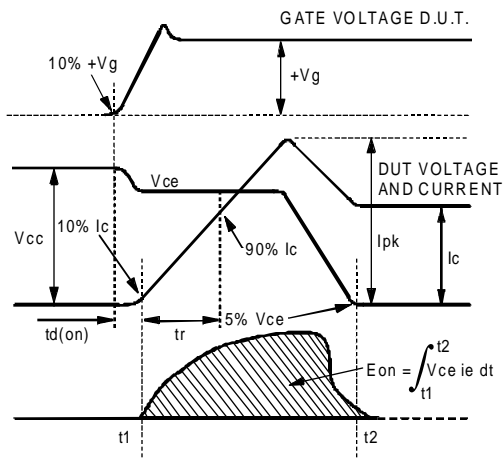

**Fig. 18c** - Test Waveforms for Circuit of Fig. 18a, Defining  $E_{on}$ ,  $t_{d(on)}$ ,  $t_r$

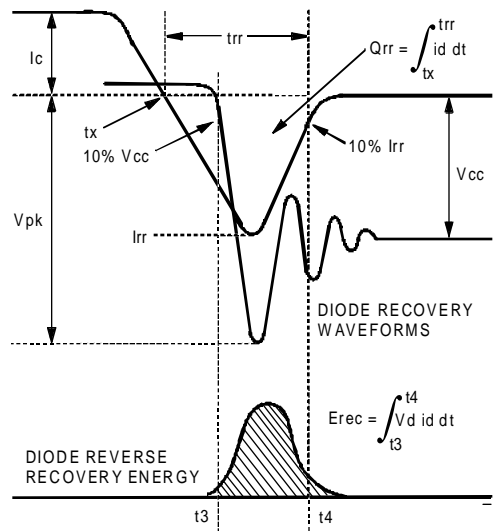

**Fig. 18d** - Test Waveforms for Circuit of Fig. 18a, Defining  $E_{rec}$ ,  $t_{tr}$ ,  $Q_{rr}$ ,  $I_{rr}$



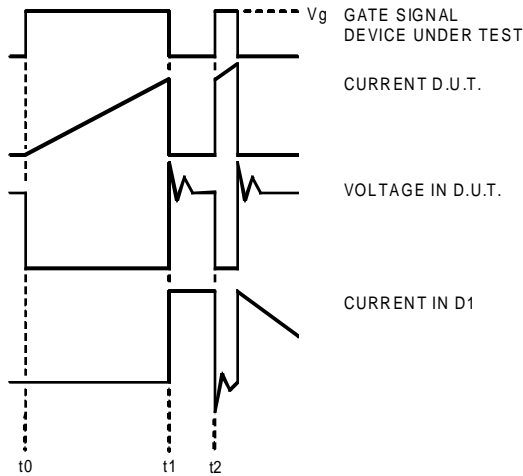

Figure 18e. Macro Waveforms for Figure 18a's Test Circuit

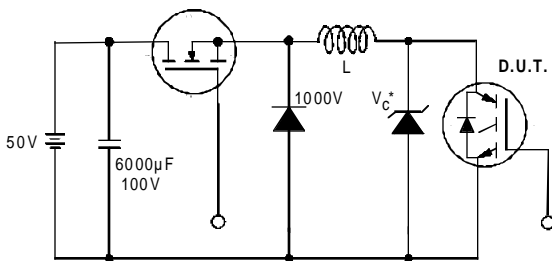

Figure 19. Clamped Inductive Load Test Circuit

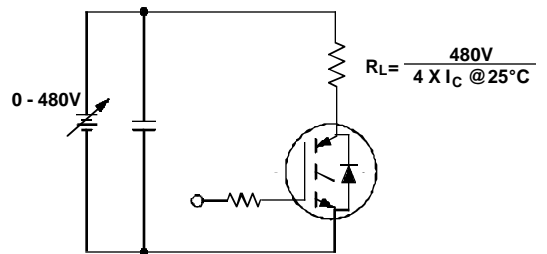

Figure 20. Pulsed Collector Current Test Circuit

## Notes:

- ① Repetitive rating:  $V_{GE}=20V$ ; pulse width limited by maximum junction temperature (figure 20)
- ②  $V_{CC}=80\%(V_{CES})$ ,  $V_{GE}=20V$ ,  $L=10\mu H$ ,  $R_G = 10\Omega$  (figure 19)
- ③ Pulse width  $\leq 80\mu s$ ; duty factor  $\leq 0.1\%$ .
- ④ Pulse width  $5.0\mu s$ , single shot.

## Case Outline — IMS-2

