

MBRF2060CT

Preferred Device

SWITCHMODE™ Schottky Power Rectifier

The SWITCHMODE Power Rectifier employs the Schottky Barrier principle in a large area metal-to-silicon power diode. State-of-the-art geometry features epitaxial construction with oxide passivation and metal overlay contact. Ideally suited for use as rectifiers in very low-voltage, high-frequency switching power supplies, free wheeling diodes and polarity protection diodes.

- Highly Stable Oxide Passivated Junction
- Very Low Forward Voltage Drop
- Matched Dual Die Construction
- High Junction Temperature Capability
- High dv/dt Capability
- Excellent Ability to Withstand Reverse Avalanche Energy Transients
- Guardring for Stress Protection
- Epoxy Meets UL94, V_O at 1/8"
- Electrically Isolated. No Isolation Hardware Required.
- UL Recognized File #E69369 (Note 1.)

Mechanical Characteristics

- Case: Epoxy, Molded
- Weight: 1.9 grams (approximately)
- Finish: All External Surfaces Corrosion Resistant and Terminal Leads are Readily Solderable
- Lead Temperature for Soldering Purposes:
260°C Max. for 10 Seconds
- Shipped 50 units per plastic tube
- Marking: B2060

MAXIMUM RATINGS

Please See the Table on the Following Page

1. UL Recognized mounting method is per Figure 4.



ON Semiconductor™

<http://onsemi.com>

**SCHOTTKY BARRIER
RECTIFIER
20 AMPERES
60 VOLTS**

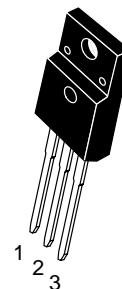
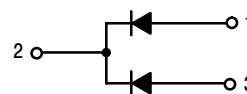

ISOLATED TO-220
CASE 221D
STYLE 3

MARKING DIAGRAM

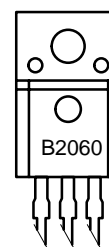

B2060 = Device Code

ORDERING INFORMATION

Device	Package	Shipping
MBRF2060CT	TO-220	50 Units/Rail

Preferred devices are recommended choices for future use and best overall value.

MBRF2060CT

MAXIMUM RATINGS (Per Leg)

Rating	Symbol	Value	Unit
Peak Repetitive Reverse Voltage Working Peak Reverse Voltage DC Blocking Voltage	V_{RRM} V_{RWM} V_R	60	Volts
Average Rectified Forward Current (Rated V_R), $T_C = 133^\circ\text{C}$ Total Device	$I_{F(AV)}$	10 20	Amps
Peak Repetitive Forward Current (Rated V_R , Square Wave, 20 kHz), $T_C = 133^\circ\text{C}$	I_{FRM}	20	Amps
Nonrepetitive Peak Surge Current (Surge applied at rated load conditions halfwave, single phase, 60 Hz)	I_{FSM}	150	Amps
Peak Repetitive Reverse Surge Current (2.0 μs , 1.0 kHz)	I_{RRM}	0.5	Amp
Operating Junction and Storage Temperature Range	T_J, T_{stg}	-65 to +150	$^\circ\text{C}$
Voltage Rate of Change (Rated V_R)	dv/dt	10000	$\text{V}/\mu\text{s}$
RMS Isolation Voltage (t = 1.0 second, R.H. $\leq 30\%$, $T_A = 25^\circ\text{C}$) (Note 2.) Per Figure 3. Per Figure 4. (Note 1.) Per Figure 5.	V_{iso1} V_{iso2} V_{iso3}	4500 3500 1500	Volts

THERMAL CHARACTERISTICS (Per Leg)

Maximum Thermal Resistance, Junction to Case	$R_{\theta JC}$	4.0	$^\circ\text{C}/\text{W}$
Lead Temperature for Soldering Purposes: 1/8" from Case for 5 Seconds	T_L	260	$^\circ\text{C}$

ELECTRICAL CHARACTERISTICS (Per Leg)

Characteristic	Symbol	Max	Unit
Maximum Instantaneous Forward Voltage (Note 3.) ($i_F = 10$ Amp, $T_C = 25^\circ\text{C}$) ($i_F = 10$ Amp, $T_C = 125^\circ\text{C}$) ($i_F = 20$ Amp, $T_C = 25^\circ\text{C}$) ($i_F = 20$ Amp, $T_C = 125^\circ\text{C}$)	v_F	0.85 0.75 0.95 0.85	Volts
Maximum Instantaneous Reverse Current (Note 3.) (Rated DC Voltage, $T_C = 25^\circ\text{C}$) (Rated DC Voltage, $T_C = 125^\circ\text{C}$)	i_R	0.15 150	mA

1. UL Recognized mounting method is per Figure 4.
2. Proper strike and creepage distance must be provided.
3. Pulse Test: Pulse Width = 300 μs , Duty Cycle $\leq 2.0\%$

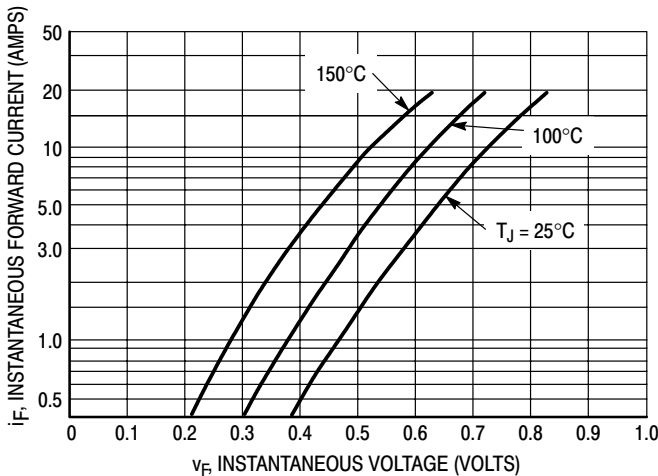

Figure 1. Typical Forward Voltage Per Diode

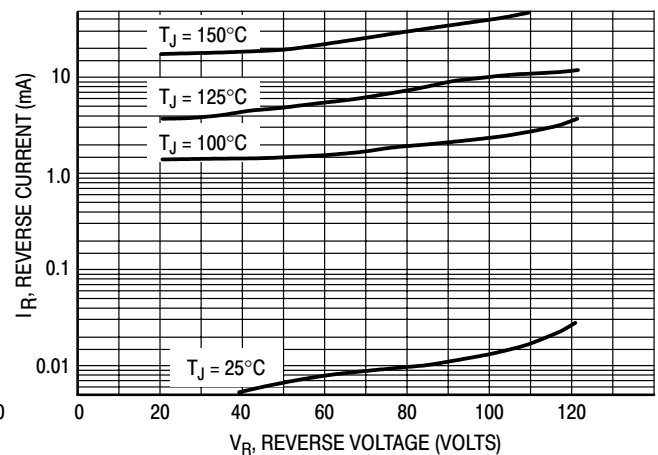

Figure 2. Typical Reverse Current Per Diode

MBRF2060CT

TEST CONDITIONS FOR ISOLATION TESTS*

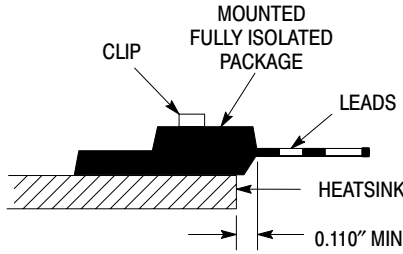

Figure 3. Clip Mounting Position for Isolation Test Number 1

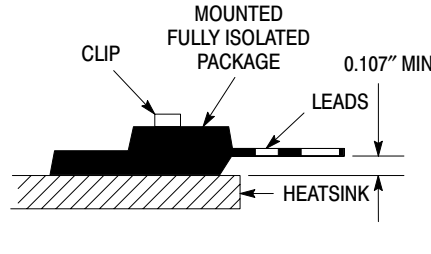

Figure 4. Clip Mounting Position for Isolation Test Number 2

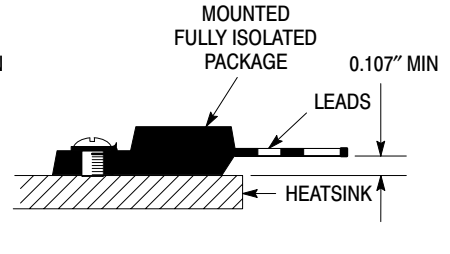
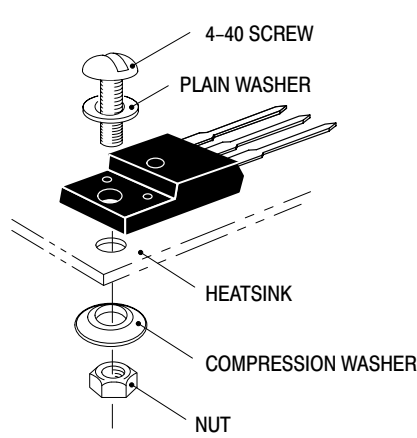

Figure 5. Screw Mounting Position for Isolation Test Number 3

* Measurement made between leads and heatsink with all leads shorted together.

MOUNTING INFORMATION**



6a. Screw-Mounted

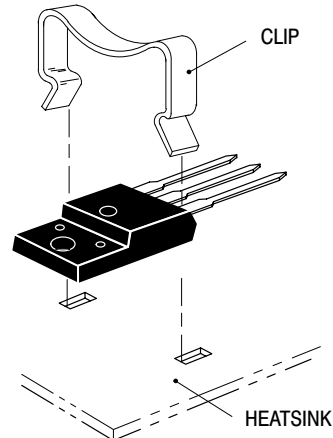

6b. Clip-Mounted

Figure 6. Typical Mounting Techniques

Laboratory tests on a limited number of samples indicate, when using the screw and compression washer mounting technique, a screw torque of 6 to 8 in · lbs is sufficient to provide maximum power dissipation capability. The compression washer helps to maintain a constant pressure on the package over time and during large temperature excursions.

Destructive laboratory tests show that using a hex head 4-40 screw, without washers, and applying a torque in excess of 20 in · lbs will cause the plastic to crack around the mounting hole, resulting in a loss of isolation capability.

Additional tests on slotted 4-40 screws indicate that the screw slot fails between 15 to 20 in · lbs without adversely affecting the package. However, in order to positively ensure the package integrity of the fully isolated device, ON Semiconductor does not recommend exceeding 10 in · lbs of mounting torque under any mounting conditions.

**For more information about mounting power semiconductors see Application Note AN1040.

MBRF2060CT

PACKAGE DIMENSIONS

TO-220
FULLPAK
CASE 221D-02
ISSUE D

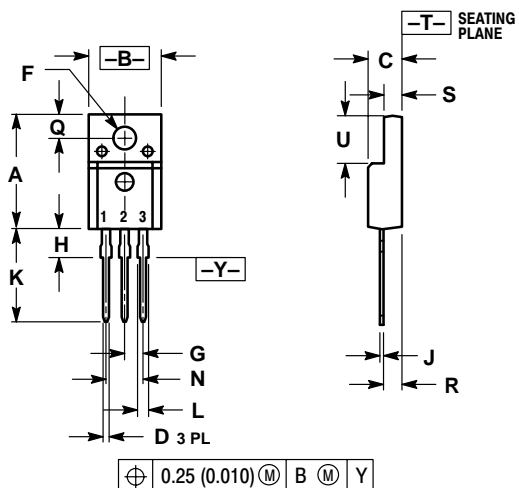

- NOTES:
1. DIMENSIONING AND TOLERANCING PER ANSI Y14.5M, 1982.
2. CONTROLLING DIMENSION: INCH.

DIM	INCHES		MILLIMETERS	
	MIN	MAX	MIN	MAX
A	0.621	0.629	15.78	15.97
B	0.394	0.402	10.01	10.21
C	0.181	0.189	4.60	4.80
D	0.026	0.034	0.67	0.86
F	0.121	0.129	3.08	3.27
G	0.100 BSC		2.54 BSC	
H	0.123	0.129	3.13	3.27
J	0.018	0.025	0.46	0.64
K	0.500	0.562	12.70	14.27
L	0.045	0.060	1.14	1.52
N	0.200 BSC		5.08 BSC	
Q	0.126	0.134	3.21	3.40
R	0.107	0.111	2.72	2.81
S	0.096	0.104	2.44	2.64
U	0.259	0.267	6.58	6.78

- STYLE 3:
PIN 1. ANODE
2. CATHODE
3. ANODE

SWITCHMODE is a trademark of Semiconductor Components Industries, LLC.

ON Semiconductor and  are trademarks of Semiconductor Components Industries, LLC (SCILLC). SCILLC reserves the right to make changes without further notice to any products herein. SCILLC makes no warranty, representation or guarantee regarding the suitability of its products for any particular purpose, nor does SCILLC assume any liability arising out of the application or use of any product or circuit, and specifically disclaims any and all liability, including without limitation special, consequential or incidental damages. "Typical" parameters which may be provided in SCILLC data sheets and/or specifications can and do vary in different applications and actual performance may vary over time. All operating parameters, including "Typicals" must be validated for each customer application by customer's technical experts. SCILLC does not convey any license under its patent rights nor the rights of others. SCILLC products are not designed, intended, or authorized for use as components in systems intended for surgical implant into the body, or other applications intended to support or sustain life, or for any other application in which the failure of the SCILLC product could create a situation where personal injury or death may occur. Should Buyer purchase or use SCILLC products for any such unintended or unauthorized application, Buyer shall indemnify and hold SCILLC and its officers, employees, subsidiaries, affiliates, and distributors harmless against all claims, costs, damages, and expenses, and reasonable attorney fees arising out of, directly or indirectly, any claim of personal injury or death associated with such unintended or unauthorized use, even if such claim alleges that SCILLC was negligent regarding the design or manufacture of the part. SCILLC is an Equal Opportunity/Affirmative Action Employer.

PUBLICATION ORDERING INFORMATION

NORTH AMERICA Literature Fulfillment:

Literature Distribution Center for ON Semiconductor
P.O. Box 5163, Denver, Colorado 80217 USA
Phone: 303-675-2175 or 800-344-3860 Toll Free USA/Canada
Fax: 303-675-2176 or 800-344-3867 Toll Free USA/Canada
Email: ONlit@hibbertco.com
Fax Response Line: 303-675-2167 or 800-344-3810 Toll Free USA/Canada

N. American Technical Support: 800-282-9855 Toll Free USA/Canada

EUROPE: LDC for ON Semiconductor – European Support

German Phone: (+1) 303-308-7140 (Mon-Fri 2:30pm to 7:00pm CET)
Email: ONlit-german@hibbertco.com
French Phone: (+1) 303-308-7141 (Mon-Fri 2:00pm to 7:00pm CET)
Email: ONlit-french@hibbertco.com
English Phone: (+1) 303-308-7142 (Mon-Fri 12:00pm to 5:00pm GMT)
Email: ONlit@hibbertco.com

EUROPEAN TOLL-FREE ACCESS*: 00-800-4422-3781

*Available from Germany, France, Italy, UK, Ireland

CENTRAL/SOUTH AMERICA:

Spanish Phone: 303-308-7143 (Mon-Fri 8:00am to 5:00pm MST)
Email: ONlit-spanish@hibbertco.com
Toll-Free from Mexico: Dial 01-800-288-2872 for Access –
then Dial 866-297-9322

ASIA/PACIFIC: LDC for ON Semiconductor – Asia Support

Phone: 303-675-2121 (Tue-Fri 9:00am to 1:00pm, Hong Kong Time)
Toll Free from Hong Kong & Singapore:
001-800-4422-3781
Email: ONlit-asia@hibbertco.com

JAPAN: ON Semiconductor, Japan Customer Focus Center

4-32-1 Nishi-Gotanda, Shinagawa-ku, Tokyo, Japan 141-0031
Phone: 81-3-5740-2700
Email: r14525@onsemi.com

ON Semiconductor Website: <http://onsemi.com>

For additional information, please contact your local Sales Representative.