



### Typical Applications

4x2 Switch Matrix for 0.2 - 3.0 GHz Applications:

- Cable Modem
- CATV
- Cellular Systems
- DBS

### Functional Diagram

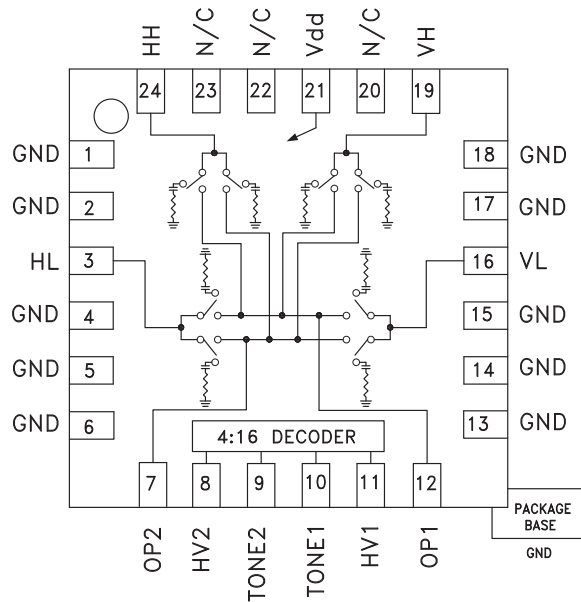

### Features

- 4x2 Switch Matrix Using One IC
- 4x4 Switch Matrix Using Two ICs
- Integrated 4 Bit Decoder
- Single Positive Supply:  $V_{dd} = +5V$
- QFN Leadless SMT Package, 16 mm<sup>2</sup>

### General Description

The HMC276LP4 & HMC276LP4E are low-cost 4x2 switch matrices in leadless QFN 4x4 mm surface mount packages for use in RF multiplexing applications from 200 to 3000 MHz. A positive voltage controlled 4 bit decoder is integrated on the switch. The switches may be used in either 75 ohm or 50 ohm systems.

Both switch outputs (OP1 & OP2) can independently select any of the four inputs (HH, HL, VH, VL) or simultaneously select the same inputs. Note that the switch is bi-directional and input/output functionality may be interchanged. The recommended loading impedance is 62.5 ohms on each input (HH, HL, VH, VL) and 75 ohms on each output (OP1 & OP2). All data presented was measured in a 50 ohm (input/output) system.

### Electrical Specifications, $T_A = +25^\circ C$ , $V_{dd} = +5V$ , 50 Ohm System

Parameter	Frequency	Min.	Typ.	Max.	Units
Insertion Loss	200 MHz		6.0		dB
	700 - 3000 MHz		6.0	7.0	dB
Isolation	200 MHz		55		dB
	700 - 950 MHz	40	44		dB
	950 - 1450 MHz	See OP1/2 Isolation Tables			dB
	1450 - 2150 MHz	33	37		dB
	2150 - 3000 MHz	31	35		dB
Return Loss (Input; VL, HL, VH, HH)	200 MHz		25		dB
	700 - 3000 MHz	14	18		dB
Return Loss (Output; OP1, OP2)	200 MHz		20		dB
	700 - 3000 MHz	16	20		dB
Output IP3	700 - 3000 MHz	31	37		dBm
Input Power for 1 dB Compression	700 - 3000 MHz	22	26		dBm
Switching Speed	700 - 3000 MHz	$t_{RISE} / t_{FALL}$ (10/90% RF)	140		ns
		$t_{ON} / t_{OFF}$ (50% CTL to 10/90% RF)	350		ns



### OP1 Isolation 950 - 1450 MHz

Input to Output State	Interfering Signal	State	Min. (dB)	Typ. (dB)
HL to OP1	VL to OP1	9	38	41
	All Other States	All Other States	40	>43
VL to OP1	All States	All States	43	>46
VH to OP1	All States	All States	43	>46
HH to OP1	HL to OP1	15	38	41
	All Other States	All Other States	41	>44

### OP2 Isolation 950 - 1450 MHz

Input to Output State	Interfering Signal	State	Min. (dB)	Typ. (dB)
HL to OP2	All States	All States	42	>45
VH to OP2	VL to OP2	2	38	41
	All Other States	All Other States	41	>44
VL to OP2	HL to OP2	9	38	41
	All Other States	All Other States	40	>43
HH to OP2	All States	All States	45	>48

### Insertion Loss on OP1

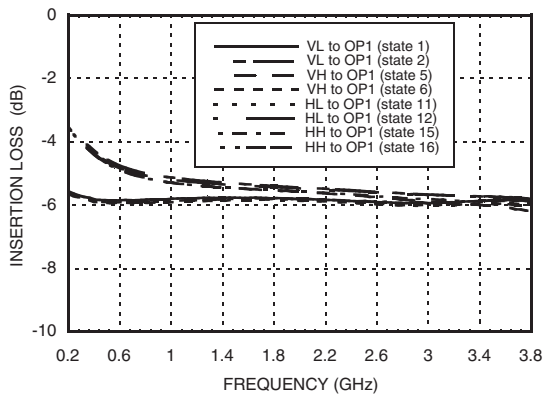

### Insertion Loss on OP2

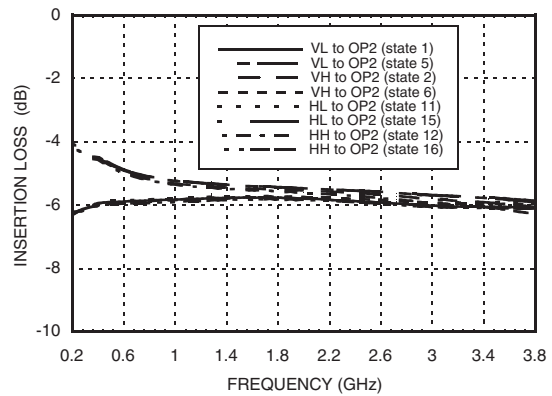

### Return Loss

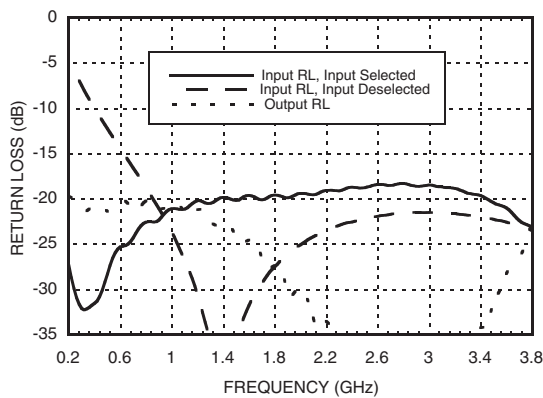

### Typical Insertion Loss vs. Temperature

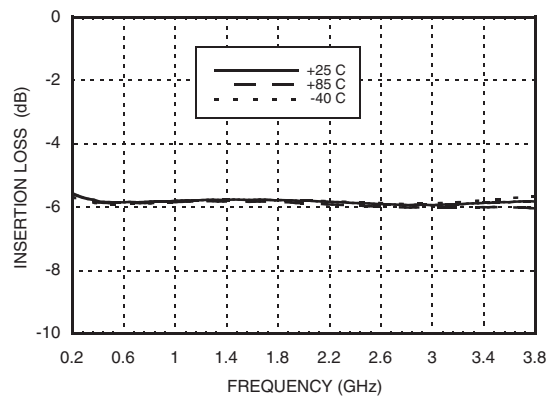

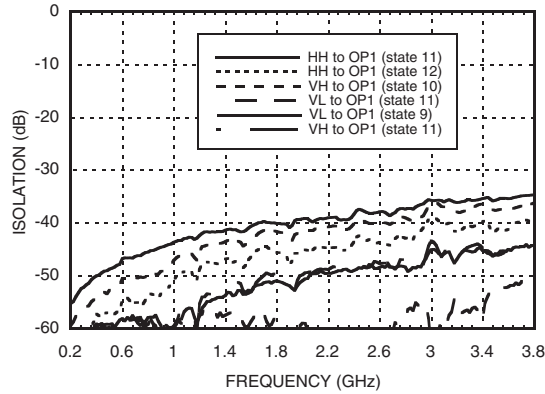
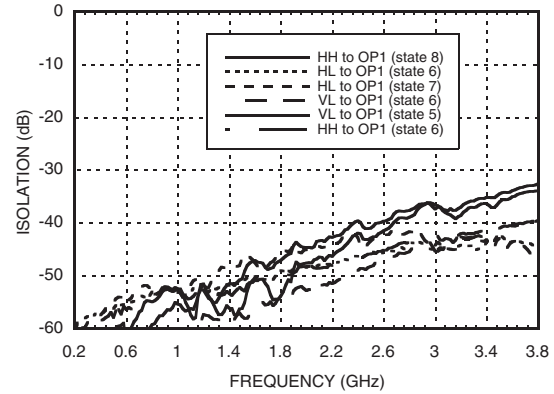
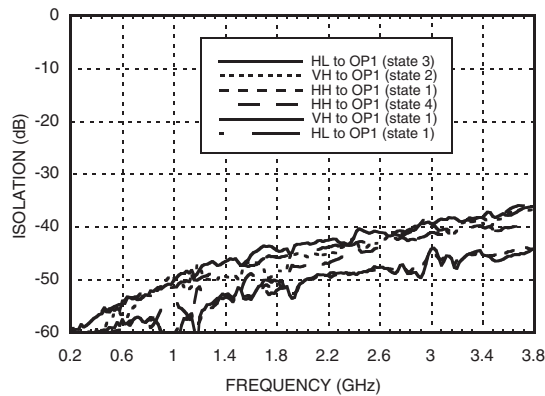
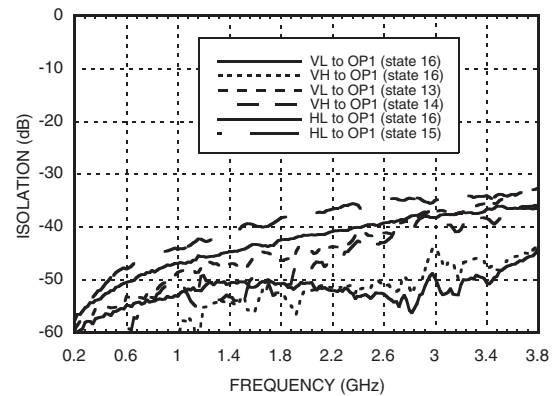
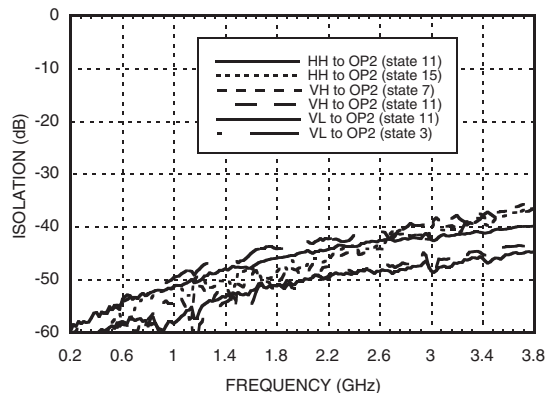
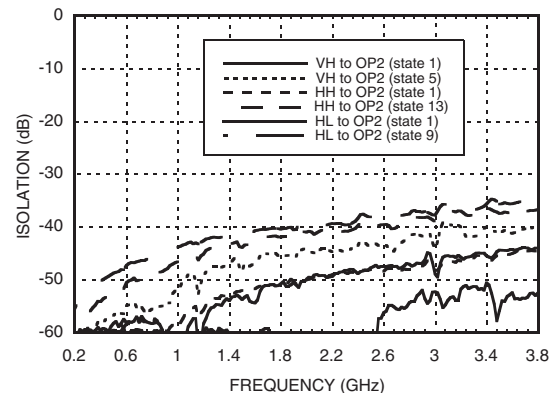
**Isolation When HL is Connected to OP1\***

**Isolation When VH is Connected to OP1\***

**Isolation When VL is Connected to OP1\***

**Isolation When HH is Connected to OP1\***

**Isolation When HL is Connected to OP2\***

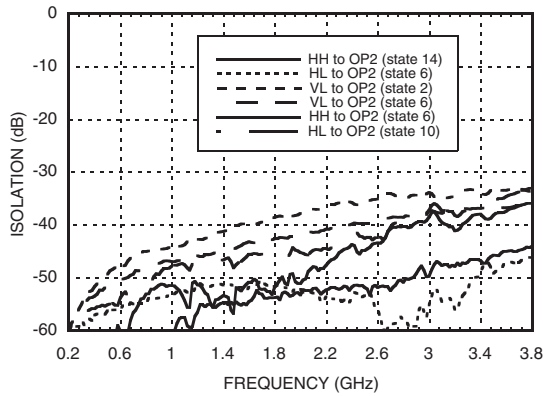
**Isolation When VL is Connected to OP2\***

\* Isolation is recorded above insertion loss & measured at output of switch.

For price, delivery, and to place orders, please contact Hittite Microwave Corporation:  
 20 Alpha Road, Chelmsford, MA 01824 Phone: 978-250-3343 Fax: 978-250-3373  
 Order On-line at [www.hittite.com](http://www.hittite.com)



**Isolation When VH is Connected to OP2\***



**Isolation When HH is Connected to OP2\***

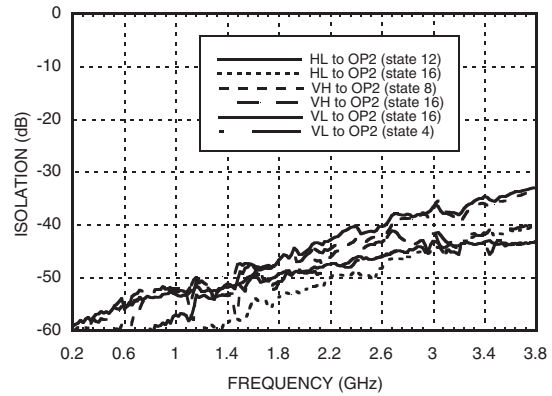

### Output Third Order Intercept Point

Path	State	F1 Pout (dBm)	Pout Intermod (dBm)	IMR (dBc)	Output IP3 (dBm)
VL to OP1	1	-12	-106	94	35
VL to OP2	1	-12	-114	102	39
HL to OP1	11	-12	-108	96	36
HL to OP2	11	-12	-110	98	37
VH to OP1	6	-12	-115	103	39.5
VH to OP2	6	-12	-115	103	39.5
HH to OP1	16	-12	-116	104	40
HH to OP2	16	-12	-114	102	39
Test Conditions					
Temperature = +25° C					
F1 = 2150 (MHz): -12 dBm at the Output				Vdd = +5V	
F2 = 2151 (MHz): -12 dBm at the Output				VCTL Low = 0V, High = +5V	

\* Isolation is recorded above insertion loss & measured at output of switch.

**Truth Table**

State	Control Input				Output to Input State		RF Path State							
	HV 1	Tone 1	HV 2	Tone 2	OP1	OP2	VL to OP1	HL to OP1	VH to OP1	HH to OP1	VL to OP2	HL to OP2	VH to OP2	HH to OP2
1	0	0	0	0	VL	VL	LOSS	ISOL	ISOL	ISOL	LOSS	ISOL	ISOL	ISOL
2	0	0	0	1	VL	VH	LOSS	ISOL	ISOL	ISOL	ISOL	ISOL	LOSS	ISOL
3	0	0	1	0	VL	HL	LOSS	ISOL	ISOL	ISOL	ISOL	LOSS	ISOL	ISOL
4	0	0	1	1	VL	HH	LOSS	ISOL	ISOL	ISOL	ISOL	ISOL	ISOL	LOSS
5	0	1	0	0	VH	VL	ISOL	ISOL	LOSS	ISOL	LOSS	ISOL	ISOL	ISOL
6	0	1	0	1	VH	VH	ISOL	ISOL	LOSS	ISOL	ISOL	ISOL	LOSS	ISOL
7	0	1	1	0	VH	HL	ISOL	ISOL	LOSS	ISOL	ISOL	LOSS	ISOL	ISOL
8	0	1	1	1	VH	HH	ISOL	ISOL	LOSS	ISOL	ISOL	ISOL	ISOL	LOSS
9	1	0	0	0	HL	VL	ISOL	LOSS	ISOL	ISOL	LOSS	ISOL	ISOL	ISOL
10	1	0	0	1	HL	VH	ISOL	LOSS	ISOL	ISOL	ISOL	ISOL	LOSS	ISOL
11	1	0	1	0	HL	HL	ISOL	LOSS	ISOL	ISOL	ISOL	LOSS	ISOL	ISOL
12	1	0	1	1	HL	HH	ISOL	LOSS	ISOL	ISOL	ISOL	ISOL	ISOL	LOSS
13	1	1	0	0	HH	VL	ISOL	ISOL	ISOL	LOSS	LOSS	ISOL	ISOL	ISOL
14	1	1	0	1	HH	VH	ISOL	ISOL	ISOL	LOSS	ISOL	ISOL	LOSS	ISOL
15	1	1	1	0	HH	HL	ISOL	ISOL	ISOL	LOSS	ISOL	LOSS	ISOL	ISOL
16	1	1	1	1	HH	HH	ISOL	ISOL	ISOL	LOSS	ISOL	ISOL	ISOL	LOSS

**Control Voltages**

HV1, Tone1, HV2, Tone2

State	Bias Condition
Low (0)	0 to 0.8 Vdc @ 5 $\mu$ A Typical
High (1)	+2.0 to +5.0 Vdc @ 25 $\mu$ A Typical

**Bias Voltage**

Vdd Range = +5.0 Vdc $\pm$ 10 %		
Vdd (Vdc)	Idd (Typ.) (mA)	Idd (Max.) (mA)
+5.0	1	1.5

**DC Blocking And Decoupling Capacitors**

The HMC276LP4 requires DC blocks on all 6 RF ports (OP1, OP2, VL, HL, VH, HH). Characterization on the HMC276LP4 was done using 0402 size 330pF capacitors on all RF ports. A 1,000 pF DC decoupling capacitor (0603 size) is recommended for the Vdd pin.

### Absolute Maximum Ratings

Bias Voltage Range (Vdd)	+8.0 Vdc
Control Voltage Range (All Logic Lines)	Vdd +0.5 to -0.2V Vdc
Channel Temperature	150 °C
Thermal Resistance	325 °C/W
Storage Temperature	-65 to +150 °C
Operating Temperature	-40 to +85 °C
Maximum Input Power (Each Input)	+23 dBm (200 - 2150 MHz)



ELECTROSTATIC SENSITIVE DEVICE  
OBSERVE HANDLING PRECAUTIONS

### Outline Drawing

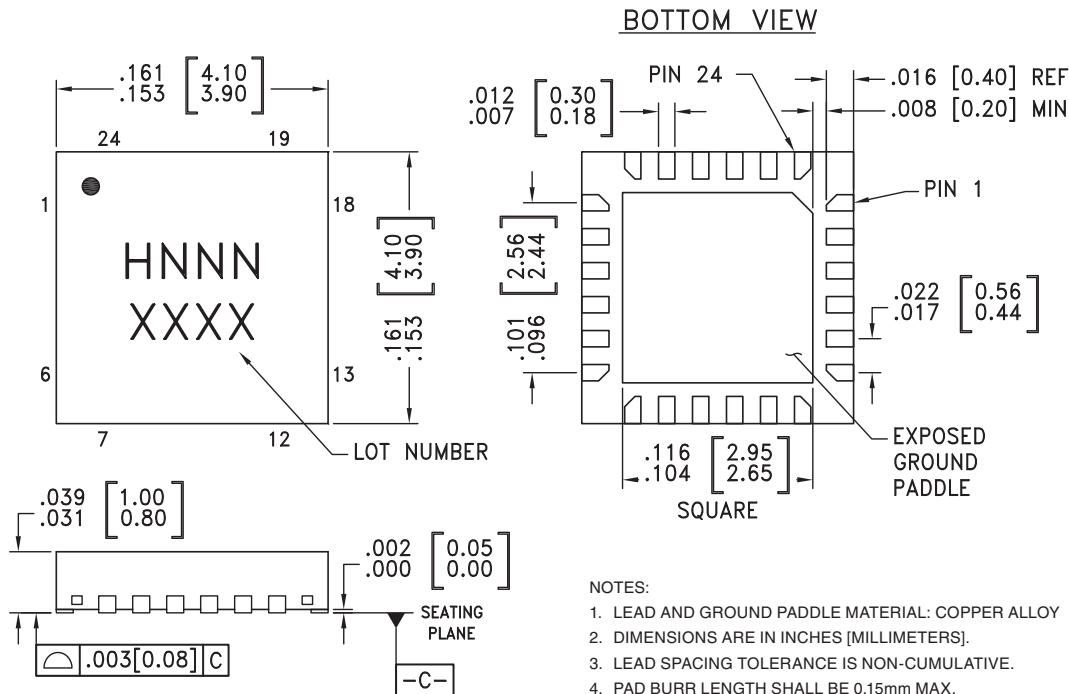

NOTES:

1. LEAD AND GROUND PADDLE MATERIAL: COPPER ALLOY
2. DIMENSIONS ARE IN INCHES [MILLIMETERS].
3. LEAD SPACING TOLERANCE IS NON-CUMULATIVE.
4. PAD BURR LENGTH SHALL BE 0.15mm MAX.  
PAD BURR HEIGHT SHALL BE 0.05mm MAX.
5. PACKAGE WARP SHALL NOT EXCEED 0.05mm.
6. ALL NC LEADS, GROUND LEADS AND GROUND PADDLE MUST BE SOLDERED TO PCB RF GROUND.
7. REFER TO HITTITE APPLICATION NOTE FOR SUGGESTED PCB LAND PATTERN.

### Package Information

Part Number	Package Body Material	Lead Finish	MSL Rating	Package Marking <sup>[3]</sup>
HMC276LP4	Low Stress Injection Molded Plastic	Sn/Pb Solder	MSL1 <sup>[1]</sup>	H276 XXXX
HMC276LP4E	RoHS-compliant Low Stress Injection Molded Plastic	100% matte Sn	MSL1 <sup>[2]</sup>	H276 XXXX

[1] Max peak reflow temperature of 235 °C

[2] Max peak reflow temperature of 260 °C

[3] 4-Digit lot number XXXX

### Switch Application Circuit for 4x4 Switch Matrix

The HMC276LP4 switch can operate as a 4x4 switch by connecting the 4 inputs of two switches directly together.

The VL, VH, HL, and HH inputs of the first switch should be connected to the second switch, as illustrated.

Mirror image switch performance can be realized by inverting the HV1 & HV2 logic control signals of one of the HMC276LP4 switches.

The input loading impedance of two switches in parallel should be 31.25 ohms. The output loading impedance on each output should be 75 ohms. The interconnect RF line between the switch's inputs should be an RF trace with a characteristic impedance of 62.5 ohms. This will allow the switch to remain matched in all possible switch states.

The HMC276LP4 does not provide output to output (OP1 to OP2) isolation. For this reason, it is recommended that external amplifiers should be used at each output. The amplifier's reverse isolation will provide output to output isolation, if this is necessary.

Each HMC276LP4 requires DC blocking capacitors on ALL RF input and output ports.

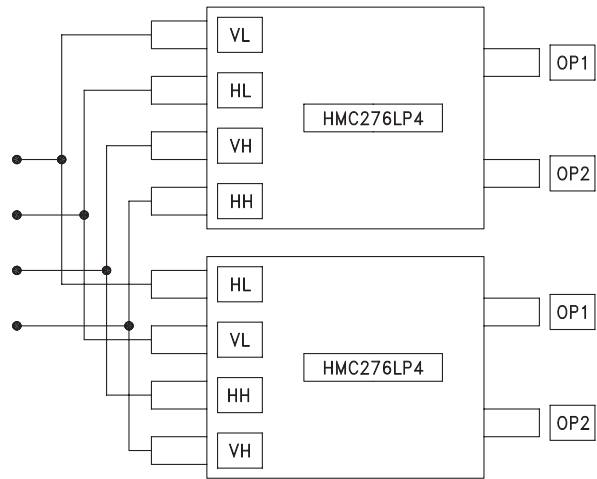

### Evaluation PCB

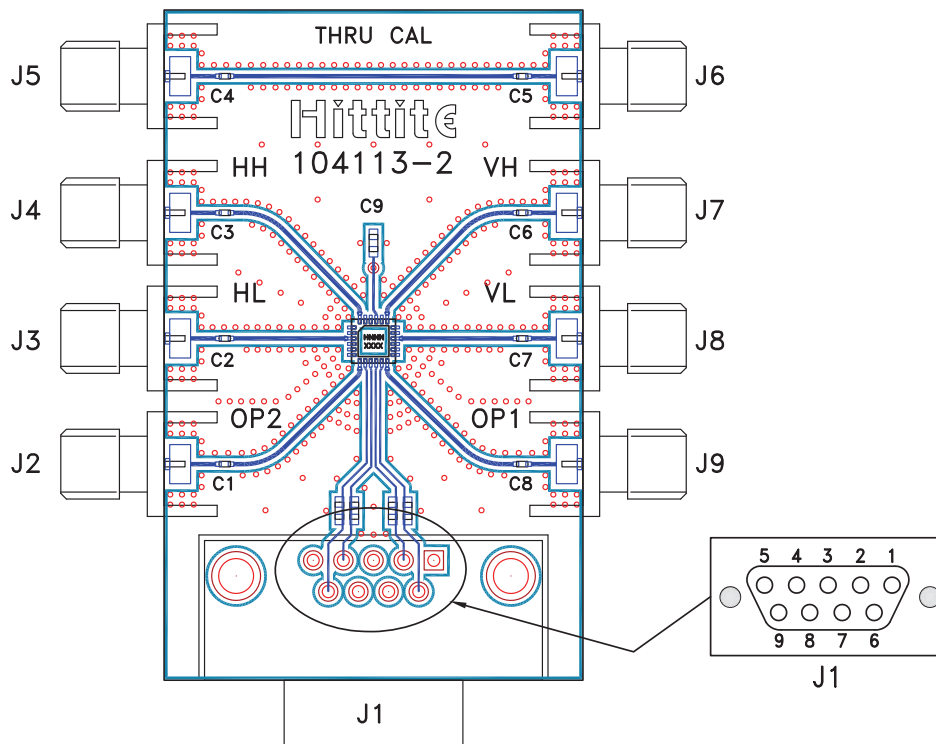

The circuit board used in the final application should be generated with proper RF circuit design techniques. Signal lines at the RF port should have 50 ohm impedance and the package ground leads and exposed paddle should be connected directly to the ground plane similar to that shown above. A generous number of ground vias should be used to interconnect top/bottom ground planes. The evaluation circuit board shown above is available from Hittite Microwave Corporation upon request.

### List of Materials for Evaluation PCB 104130 [1]

Item	Description
J2 - J9	PCB Mount SMA RF Connector
J1	DC Connector
C1 - C8	330 pF Capacitor, 0402 Pkg.
C9	1,000 pF Capacitor, 0603 Pkg.
U1	HMC276LP4 / HMC276LP4E 4x2 Switch Matrix
PCB [2]	104113 Eval Board

[1] Reference this number when ordering complete evaluation PCB

[2] Circuit Board Material: Rogers 4350

### Multi Pin DC Interface (J1)

Pin	Line
1	Vdd
2	Tone 1
3	GND
4	Tone 2
5	GND
6	HV1
7	N/C
8	N/C
9	HV2