

CS51021A, CS51022A, CS51023A, CS51024A

Enhanced Current Mode PWM Controller

The CS51021A/2A/3A/4A Fixed Frequency PWM Current Mode Controller family provides all necessary features required for AC–DC or DC–DC primary side control. Several features are included eliminating the additional components needed to implement them externally. In addition to low startup current (75 μ A) and high frequency operation capability, the CS51021A/2A/3A/4A family includes overvoltage and undervoltage monitoring, externally programmable dual threshold overcurrent protection, current sense leading edge blanking, current slope compensation, accurate duty cycle control and an externally available 5.0 V reference. The CS51021A and CS51023A feature bidirectional synchronization capability, while the CS51022A and CS51024A offer a sleep mode with 100 μ A maximum IC current consumption. The CS51021A/2A/3A/4A family is available in a 16 lead narrow body SOIC package.

Device	Sleep/Synch	V _{CC} Start/Stop
CS51021A	Synch	8.25 V/7.7 V
CS51022A	Sleep	8.25 V/7.7 V
CS51023A	Synch	13 V/7.7 V
CS51024A	Sleep	13 V/7.7 V

Features

- 75 μ A Max. Startup Current
- Fixed Frequency Current Mode Control
- 1.0 MHz Switching Frequency
- Undervoltage Protection Monitor
- Overvoltage Protection Monitor with Programmable Hysteresis
- Programmable Dual Threshold Overcurrent Protection with Delayed Restart
- Programmable Soft Start
- Accurate Maximum Duty Cycle Limit
- Programmable Slope Compensation
- Leading Edge Current Sense Blanking
- 1.0 A Sink/Source Gate Drive
- Bidirectional Synchronization (CS51021A/3A)
- 50 ns PWM Propagation Delay
- 100 μ A Max Sleep Current (CS51022A/4A)
- Pb–Free Packages are Available*

*For additional information on our Pb–Free strategy and soldering details, please download the ON Semiconductor Soldering and Mounting Techniques Reference Manual, SOLDERRM/D.



ON Semiconductor[®]

<http://onsemi.com>

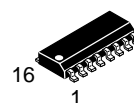

**SOIC–16
D SUFFIX
CASE 751B**

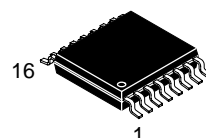

**TSSOP–16
DTB SUFFIX
CASE 948F**

PIN CONNECTIONS AND MARKING DIAGRAMS

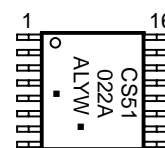
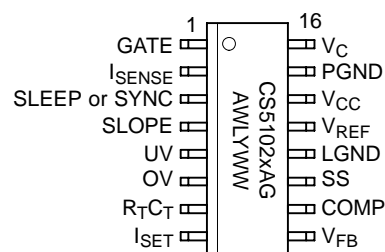

x = Specific Device Code
A = Assembly Location
WL, L = Wafer Lot
Y = Year
WW, W = Work Week
G or ■ = Pb–Free Package

ORDERING INFORMATION

See detailed ordering and shipping information in the package dimensions section on page 9 of this data sheet.

CS51021A, CS51022A, CS51023A, CS51024A

ELECTRICAL CHARACTERISTICS (Unless otherwise stated, specifications apply for $-40^{\circ}\text{C} < T_A < 85^{\circ}\text{C}$, $-40^{\circ}\text{C} < T_J < 150^{\circ}\text{C}$, $3.0\text{ V} < V_C < 20\text{ V}$, $8.2\text{ V} < V_{CC} < 20\text{ V}$, $R_T = 12\text{ k}\Omega$, $C_T = 390\text{ pF}$)

Characteristic	Test Conditions	Min	Typ	Max	Unit
Under Voltage Lockout					
START Threshold (CS51021A/2A)	–	7.95	8.25	8.8	V
START Threshold (CS51023A/4A)	–	12.4	13	13.4	V
STOP Threshold	–	7.4	7.7	8.2	V
Hysteresis (CS51021A/2A)	–	0.50	0.75	1.00	V
Hysteresis (CS51023A/4A)	–	4.0	5.0	6.0	V
I_{CC} @ Startup (CS51021A/2A)	$V_{CC} < UV_{START}$ Threshold	–	40	75	μA
I_{CC} @ Startup (CS51023A/4A)	$V_{CC} < UV_{START}$ Threshold	–	45	75	μA
I_{CC} Operating (CS51021A/3A)	–	–	7.0	9.0	mA
I_{CC} Operating (CS51022A/4A)	–	–	6.0	8.0	mA
I_{CC} Operating	Includes 1.0 nF Load	–	7.0	12	mA

Voltage Reference

Initial Accuracy	$T_A = 25^{\circ}\text{C}$, $I_{REF} = 2.0\text{ mA}$, $V_{CC} = 14\text{ V}$, (Note 2)	4.95	5.0	5.05	V
Total Accuracy	$1.0\text{ mA} < I_{REF} < 10\text{ mA}$	4.9	5.0	5.15	V
Line Regulation	$8.2\text{ V} < V_{CC} < 18\text{ V}$, $I_{REF} = 2.0\text{ mA}$	–	6.0	20	mV
Load Regulation	$1.0\text{ mA} < I_{REF} < 10\text{ mA}$	–	6.0	15	mV
NOISE Voltage	(Note 2)	–	50	–	μV
OP Life Shift	$T = 1000\text{ Hours}$, (Note 2)	–	4.0	20	mV
FAULT Voltage	Force V_{REF}	$0.90 \times V_{REF}$	$0.93 \times V_{REF}$	$0.95 \times V_{REF}$	V
OK Voltage	Force V_{REF}	$0.94 \times V_{REF}$	$0.96 \times V_{REF}$	$0.985 \times V_{REF}$	V
OK Hysteresis	Force V_{REF}	75	165	250	mV
Current Limit	Force V_{REF}	–20	–	–	mA

Error Amplifier

Initial Accuracy	$T_A = 25^{\circ}\text{C}$, $I_{REF} = 2.0\text{ mA}$, $V_{CC} = 14\text{ V}$, $V_{FB} = \text{COMP}$, (Note 2)	2.465	2.515	2.565	V
Reference Voltage	$V_{FB} = \text{COMP}$	2.440	2.515	2.590	V
V_{FB} Leakage Current	$V_{FB} = 0\text{ V}$	–	–0.2	–2.0	μA
Open Loop Gain	$1.4\text{ V} < \text{COMP} < 4.0\text{ V}$, (Note 2)	60	90	–	dB
Unity Gain Bandwidth	(Note 2)	1.5	2.5	–	MHz
COMP Sink Current	$\text{COMP} = 1.5\text{ V}$, $V_{FB} = 2.7\text{ V}$	2.0	6.0	–	mA
COMP Source Current	$\text{COMP} = 1.5\text{ V}$, $V_{FB} = 2.3\text{ V}$	–0.2	–0.5	–	mA
COMP High Voltage	$V_{FB} = 2.3\text{ V}$	4.35	4.8	5.0	V
COMP Low Voltage	$V_{FB} = 2.7\text{ V}$	0.4	0.8	1.2	V
PS Ripple Rejection	$\text{FREQ} = 120\text{ Hz}$, (Note 2)	60	85	–	dB
SS Clamp, V_{COMP}	$V_{SS} = 2.5\text{ V}$, $V_{FB} = 0\text{ V}$, $I_{SET} = 2.0\text{ V}$	2.4	2.5	2.6	V
$I_{LIM(SET)}$ Clamp	(Note 2)	0.95	1.0	1.15	V

2. Guaranteed by design, not 100% tested in production.

CS51021A, CS51022A, CS51023A, CS51024A

ELECTRICAL CHARACTERISTICS (Unless otherwise stated, specifications apply for $-40^{\circ}\text{C} < T_A < 85^{\circ}\text{C}$, $-40^{\circ}\text{C} < T_J < 150^{\circ}\text{C}$, $3.0\text{ V} < V_C < 20\text{ V}$, $8.2\text{ V} < V_{CC} < 20\text{ V}$, $R_T = 12\text{ k}\Omega$, $C_T = 390\text{ pF}$)

Characteristic	Test Conditions	Min	Typ	Max	Unit
----------------	-----------------	-----	-----	-----	------

Oscillator

Accuracy	$R_T = 12\text{ k}$, $C_T = 390\text{ pF}$	230	255	280	kHz
Voltage Stability	Delta Frequency $8.2\text{ V} < V_{CC} < 20\text{ V}$	–	2.0	3.0	%
Temperature Stability	$T_{MIN} < T_A < T_{MAX}$, (Note 3)	–	8.0	–	%
Min Charge & Discharge Time	(Note 3)	0.333	–	–	μs
Duty Cycle Accuracy	$R_T = 12\text{ k}$, $C_T = 390\text{ pF}$	70	77	83	%
Peak Voltage	(Note 3)	–	3.0	–	V
Valley Voltage	(Note 3)	–	1.5	–	V
Valley Clamp Voltage	10 k Resistor to ground on $R_T C_T$	1.2	1.4	1.6	V
Discharge Current	–	0.8	1.0	1.2	mA
Discharge Current	$T_A = 25^{\circ}\text{C}$, Note 3	0.925	1.0	1.075	mA

Synchronization (CS51021A/3A)

Input Threshold	–	1.0	1.5	2.7	V
Output Pulsewidth	–	160	260	400	ns
Output High Voltage	$I_{SYNC} = 100\ \mu\text{A}$	3.5	4.3	4.8	V
Input Resistance	(Note 3)	35	70	140	$\text{k}\Omega$
Drive Delay	SYNC to GATE RESET	80	120	150	ns
Output Drive Current	1.0 k Load	1.25	2.0	3.5	mA

SLEEP (CS51022A/4A)

SLEEP Input Threshold	Active High	1.0	1.5	2.7	V
SLEEP Input Current	$V_{SLEEP} = 4.0\text{ V}$	11	25	46	μA
I_{CC} @ SLEEP	$V_{CC} \leq 15\text{ V}$	–	50	100	μA

GATE Driver

HIGH Voltage	Measure V_C – GATE, $V_C = 10\text{ V}$, 150 mA Load	–	1.5	2.2	V
LOW Voltage	Measure GATE – PGND, 150 mA SINK	–	1.2	1.5	V
HIGH Voltage Clamp	$V_C = 20\text{ V}$, 1.0 nF	11	13.5	16	V
LOW Voltage Clamp	Measured at 10 mA Output Current	–	0.6	0.8	V
Peak Current	$V_C = 20\text{ V}$, 1.0 nF, (Note 3)	–	1.0	–	A
UVL Leakage	$V_C = 20\text{ V}$ measured at 0 V	–	–1.0	–50	μA
RISE Time	Load = 1.0 nF, $1.0\text{ V} < \text{GATE} < 9.0\text{ V}$, $V_C = 20\text{ V}$, $T_A = 25^{\circ}\text{C}$	–	60	100	ns
FALL Time	Load = 1.0 nF, $9.0\text{ V} > \text{GATE} > 1.0\text{ V}$, $V_C = 20\text{ V}$	–	15	40	ns

SLOPE Compensation

Charge Current	SLOPE = 2.0 V	–63	–53	–43	μA
COMP Gain	Fraction of slope voltage added to I_{SENSE} , (Note 3)	0.095	0.100	0.105	V/V
Discharge Voltage	SYNC = 0 V	–	0.1	0.2	V

3. Guaranteed by design, not 100% tested in production.

CS51021A, CS51022A, CS51023A, CS51024A

ELECTRICAL CHARACTERISTICS (Unless otherwise stated, specifications apply for $-40^{\circ}\text{C} < T_A < 85^{\circ}\text{C}$, $-40^{\circ}\text{C} < T_J < 150^{\circ}\text{C}$, $3.0\text{ V} < V_C < 20\text{ V}$, $8.2\text{ V} < V_{CC} < 20\text{ V}$, $R_T = 12\text{ k}\Omega$, $C_T = 390\text{ pF}$)

Characteristic	Test Conditions	Min	Typ	Max	Unit
Current Sense					
OFFSET Voltage	(Note 4)	0.09	0.10	0.11	V
Blanking Time	–	–	55	160	ns
Blanking Disable Voltage	Adjust V_{FB}	1.8	2.0	2.2	V
Second Current Threshold Gain	–	1.21	1.33	1.45	V/V
I_{SENSE} Input Resistance	–	–	5.0	–	$\text{k}\Omega$
Minimum On Time	GATE High to Low	30	70	110	ns
Gain	(Note 4)	0.78	0.80	0.82	V/V

OV & UV Voltage Monitors

OV Monitor Threshold	–	2.4	2.5	2.6	V
OV Hysteresis Current	–	–10	–12.5	–15	μA
UV Monitor Threshold	–	1.38	1.45	1.52	V
UV Monitor Hysteresis	–	25	75	100	mV

SOFT START (SS)

Charge Current	SS = 2.0 V	–70	–55	–40	μA
Discharge Current	SS = 2.0 V	250	1000	–	μA
Charge Voltage, V_{SS}	–	4.4	4.7	5.0	V
Discharge Voltage, V_{SS}	–	0.25	0.27	0.30	V

4. Guaranteed by design, not 100% tested in production.

PACKAGE PIN DESCRIPTION

PIN #	PIN SYMBOL	FUNCTION
16 Lead SO Narrow		
1	GATE	External power switch driver with 1.0 A peak capability.
2	I_{SENSE}	Current sense amplifier input.
3	SYNC (CS51021A/3A)	Bi-directional synchronization. Locks to the highest frequency.
3	SLEEP (CS51022A/4A)	Active high chip disable. In sleep mode, V_{REF} and GATE are turned off.
4	SLOPE	Additional slope to the current sense signal. Internal current source charges the external capacitor.
5	UV	Undervoltage protection monitor.
6	OV	Overvoltage protection monitor.
7	$R_T C_T$	Timing resistor R_T and capacitor C_T determine oscillator frequency and maximum duty cycle, D_{MAX} .
8	I_{SET}	Voltage at this pin sets pulse-by-pulse overcurrent threshold, and second threshold (1.33 times higher) with Soft Start retrigger (hiccup mode).
9	V_{FB}	Feedback voltage input. Connected to the error amplifier inverting input.
10	COMP	Error amplifier output. Frequency compensation network is usually connected between COMP and V_{FB} pins.
11	SS	Charging external capacitor restricts error amplifier output voltage during the start or fault conditions (hiccup).
12	LGND	Logic ground.
13	V_{REF}	5.0 V reference voltage output.
14	V_{CC}	Logic supply voltage.
15	PGND	Output power stage ground connection.
16	V_C	Output power stage supply voltage.

CS51021A, CS51022A, CS51023A, CS51024A

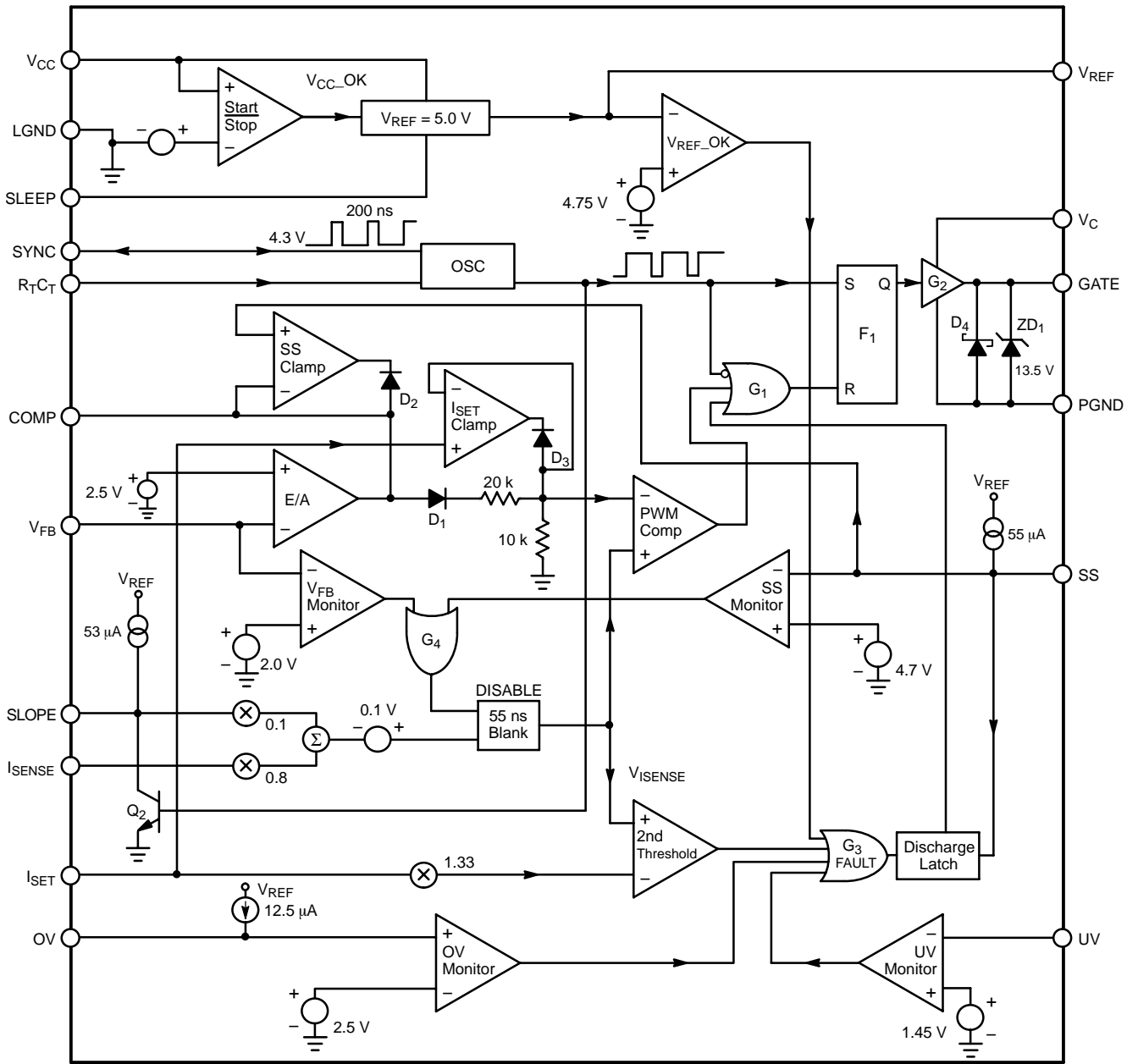

Figure 2. Block Diagram

CS51021A, CS51022A, CS51023A, CS51024A

CIRCUIT DESCRIPTION

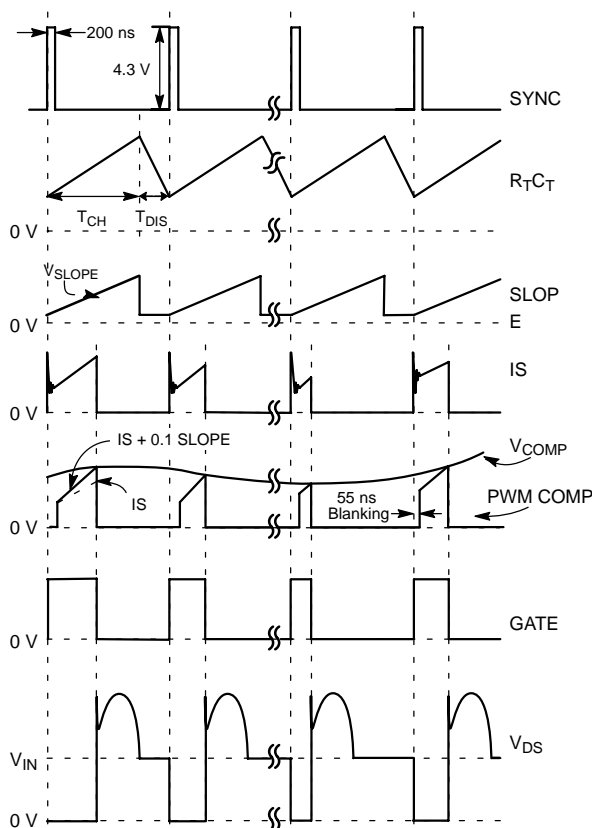

Figure 3. Typical Waveforms

THEORY OF OPERATION

Powering the IC

The IC has two supply and two ground pins. V_C and PGND pins provide high speed power drive for the external power switch. V_{CC} and LGND pins power the control portion of the IC. The internal logic monitors the supply voltage, V_{CC} . During abnormal operating conditions, the output is held low. The CS51021A/2A/3A/4A requires only 75 μ A of startup current.

Voltage Feedback

The output voltage is monitored via the V_{FB} pin and is compared with the internal 2.5 V reference. The error amplifier output minus one diode drop is divided by 3 and connected to the negative input of the PWM comparator. The positive input of the PWM comparator is connected to the modified current sense signal. The oscillator turns the external power switch on at the beginning of each cycle. When current sense ramp voltage exceeds the reference side of PWM comparator, the output stage latches off. It is turned on again at the beginning of the next oscillator cycle.

Current Sense and Protection

The current is monitored at the I_{SENSE} pin. The CS51021A/2A/3A/4A has leading edge blanking circuitry that ignores the first 55 ns of each switching period. Blanking is disabled when V_{FB} is less than 2.0 V so that the minimum on-time of the controller does not have an additional 55 ns of delay time during fault conditions. For the remaining portion of the switching period, the current sense signal, combined with a fraction of the slope compensation voltage, is applied to the positive input of the PWM comparator where it is compared with the divided by three error amplifier output voltage. The pulse-by-pulse overcurrent protection threshold is set by the voltage at the I_{SET} pin. This voltage is passed through the I_{SET} Clamp and appears at the non-inverting input of the PWM comparator, limiting its dynamic range according to the following formula:

$$\text{Overcurrent Threshold} = 0.8 \times V_I(\text{SENSE}) + 0.1 \text{ V} + 0.1 V_{\text{SLOPE}}$$

where

$V_I(\text{SENSE})$ is voltage at the I_{SENSE} pin.

and

V_{SLOPE} is voltage at the SLOPE pin.

During extreme overcurrent or short circuit conditions, the slope of the current sense signal will become much steeper than during normal operation. Due to loop propagation delay, the sensed signal will overshoot the pulse-by-pulse threshold eventually reaching the second overcurrent protection threshold which is 1.33 times higher than the first threshold and is described by the following equation:

$$\text{2nd Threshold} = 1.33 \times V_I(\text{SET})$$

Exceeding the second threshold will reset the Soft Start capacitor C_{SS} and reinitiate the Soft Start sequence, repeating for as long as the fault condition persists.

Soft Start

During power up, when the output filter capacitor is discharged and the output voltage is low, the voltage across the Soft Start capacitor (V_{SS}) controls the duty cycle. An internal current source of 55 μ A charges C_{SS} . The maximum error amplifier output voltage is clamped by the SS Clamp. When the Soft Start capacitor voltage exceeds the error amplifier output voltage, the feedback loop takes over the duty cycle control. The Soft Start time can be estimated with the following formula:

$$t_{SS} = 9 \times 10^4 \times C_{SS}$$

The Soft Start voltage, V_{SS} , charges and discharges between 0.25 V and 4.7 V.

CS51021A, CS51022A, CS51023A, CS51024A

Slope Compensation

DC–DC converters with current mode control require a current sense signal with slope compensation to avoid instability at duty cycles greater than 50%. Slope capacitor C_S is charged by an internal $53 \mu\text{A}$ current source and is discharged during the oscillator discharge time. The slope compensation voltage is divided by 10 and is added to the current sense voltage, $V_{I(\text{SENSE})}$. The signal applied to the input of the PWM comparator is a combination of these two voltages. The slope compensation, dV_{SLOPE}/dt , is calculated using the following formula:

$$\frac{dV_{\text{SLOPE}}}{dt} = 0.1 \times \frac{53 \mu\text{A}}{C_S}$$

It should be noted that internal capacitance of the IC will cause an error when determining slope compensation capacitance C_S . This error is typically small for large values of C_S , but increases as C_S becomes small and comparable to the internal capacitance. The effect is apparent as a reduction in charging current due to the need to charge the internal capacitance in parallel with C_S . Figure 4 shows a typical curve indicating this decrease in available charging current.

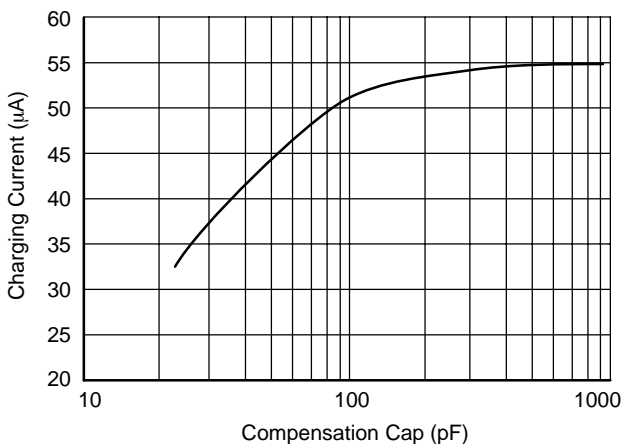

Figure 4. The Slope Compensation Pin Charge Current Reduces When a Small Capacitor Is Used.

Undervoltage (UV) and Overvoltage (OV) Monitor

Two independent comparators monitor OV and UV conditions. A string of three resistors is connected in series between the monitored voltage (usually the input voltage) and ground (see Figure 5). When voltage at the OV pin exceeds 2.5 V, an overvoltage condition is detected and GATE shuts down. An internal $12.5 \mu\text{A}$ current source turns on and feeds current into the external resistor, R_3 , creating a hysteresis determined by the value of this resistor (the higher the value, the greater the hysteresis). The hysteresis voltage of the OV monitor is determined by the following formula:

$$V_{\text{OV(HYST)}} = 12.5 \mu\text{A} \times R_3$$

where R_3 is a resistor connected from the OV pin to ground.

When the monitored voltage is low and the UV pin is less than 1.45 V, GATE shuts down. The UV pin has fixed 75 mV hysteresis.

Both OV and UV conditions are latched until the Soft Start capacitor is discharged. This way, every time a fault condition is detected the controller goes through the power up sequence.

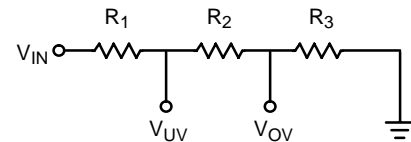

Figure 5. UV/OV Monitor Divider

To calculate the OV?UV resistor divider :

1. Solve for R_3 , based on OV hysteresis requirements.

$$R_3 = \frac{V_{\text{OV(HYST)}} \times 2.5 \text{ V}}{V_{\text{MAX}} \times 12.5 \mu\text{A}}$$

where $V_{\text{OV(HYST)}}$ is the desired amount of overvoltage hysteresis, and V_{MAX} is the input voltage at which the supply will shut down.

2. Find the total impedance of the divider.

$$R_{\text{TOT}} = R_1 + R_2 + R_3 = \frac{V_{\text{MAX}} \times R_3}{2.5}$$

3. Determine the value of R_2 from the UV threshold conditions.

$$R_2 = \frac{1.45 \times R_{\text{TOT}}}{V_{\text{MIN}}} - R_3$$

where V_{MIN} is the UV voltage at which the supply will shut down.

4. Calculate R_1 .

$$R_1 = R_{\text{TOT}} - R_2 - R_3$$

5. The undervoltage hysteresis is given by :

$$V_{\text{UV(HYST)}} = \frac{V_{\text{MIN}} \times 0.075}{1.45}$$

V_{REF} Monitor

The 5.0 V reference voltage is internally monitored to ensure that it remains within specifications. The monitor, which outputs a fault, can be tripped by two methods:

- If the reference voltage drops below 4.75 V
- If V_{CC} falls below the STOP threshold

As indicated in the block diagram, any fault causes the output to stop switching and begins the discharge of the Soft Start capacitor C_{SS} .

CS51021A, CS51022A, CS51023A, CS51024A

Synchronization

A bi-directional synchronization is provided to synchronize several controllers. When SYNC pins are connected together, the converters will lock to the highest switching frequency. The fastest controller becomes the master, producing a 4.3 V, 200 ns pulse train. Only one, the highest frequency SYNC signal, will appear on the SYNC line.

Sleep

The sleep input is an active high input. The CS51022A/4A is placed in sleep mode when SLEEP is driven high. In sleep mode, the controller and MOSFET are turned off. Connect to GND for normal operation. The sleep mode operates at $V_{CC} \leq 15$ V.

Oscillator and Duty Cycle Limit

The switching frequency is set by R_T and C_T connected to the $R_T C_T$ pin. C_T charges and discharges between 3.0 V and 1.5 V.

The maximum duty cycle is set by the ratio of the on time, t_{ON} , and the whole period, $T = t_{ON} + t_{OFF}$. Because the timing capacitor's discharge current is trimmed, the maximum duty cycle is well defined. It is determined by the ratio between the timing resistor R_T and the timing capacitor C_T . Refer to figures 6 and 7 to select appropriate values for R_T and C_T .

$$f_{SW} = \frac{1}{T_{SW}}; T_{SW} = t_{CH} + t_{DIS}$$

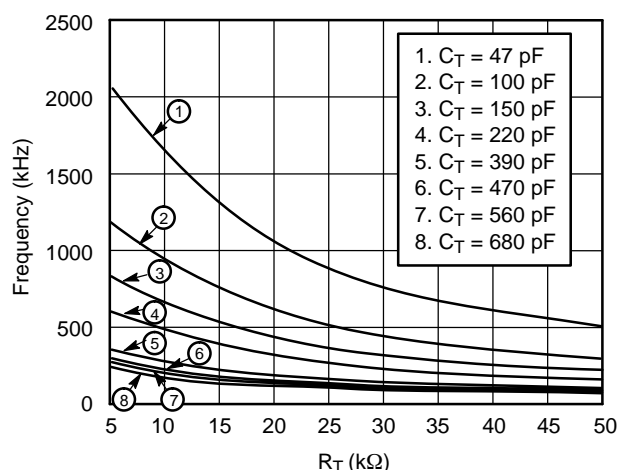

Figure 6. Frequency vs. R_T for Discrete Capacitor Values

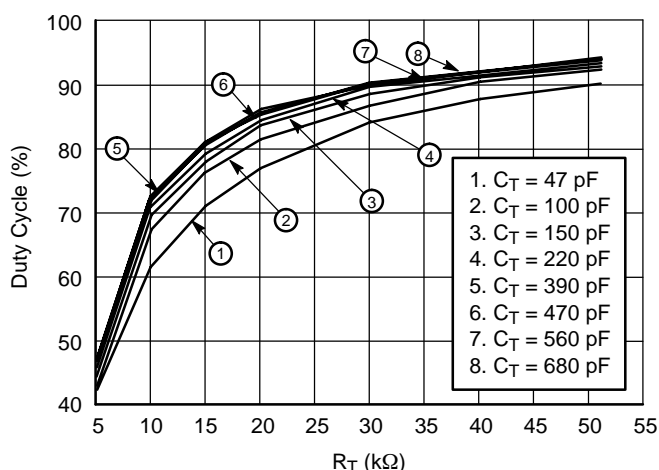

Figure 7. Duty Cycle vs. R_T for Discrete Capacitor Values

ORDERING INFORMATION

Device	Package	Shipping [†]
CS51021AED16	SOIC-16	48 Units / Rail
CS51021AEDR16		
CS51021AEDR16G	SOIC-16 (Pb-Free)	2500 Tape & Reel
CS51022ADB G	TSSOP-16*	48 Units / Rail
CS51022ADB R2G	TSSOP-16*	2500 Tape & Reel
CS51022AED16	SOIC-16	48 Units / Rail
CS51022AEDR16		
CS51022AEDR16G	SOIC-16 (Pb-Free)	2500 Tape & Reel
CS51023AED16	SOIC-16	48 Units / Rail
CS51023AEDR16		
CS51023AEDR16G	SOIC-16 (Pb-Free)	2500 Tape & Reel

[†]For information on tape and reel specifications, including part orientation and tape sizes, please refer to our Tape and Reel Packaging Specifications Brochure, BRD8011/D.

*This package is inherently Pb-Free.

CS51021A, CS51022A, CS51023A, CS51024A

PACKAGE DIMENSIONS

SOIC-16
D SUFFIX
CASE 751B-05
ISSUE J

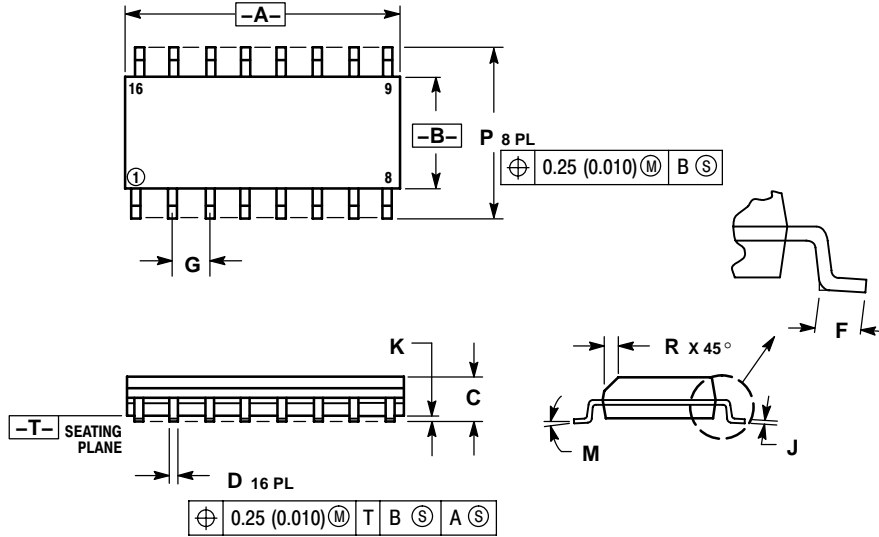

NOTES:

1. DIMENSIONING AND TOLERANCING PER ANSI Y14.5M, 1982.
2. CONTROLLING DIMENSION: MILLIMETER.
3. DIMENSIONS A AND B DO NOT INCLUDE MOLD PROTRUSION.
4. MAXIMUM MOLD PROTRUSION 0.15 (0.006) PER SIDE.
5. DIMENSION D DOES NOT INCLUDE DAMBAR PROTRUSION. ALLOWABLE DAMBAR PROTRUSION SHALL BE 0.127 (0.005) TOTAL IN EXCESS OF THE D DIMENSION AT MAXIMUM MATERIAL CONDITION.

DIM	MILLIMETERS		INCHES	
	MIN	MAX	MIN	MAX
A	9.80	10.00	0.386	0.393
B	3.80	4.00	0.150	0.157
C	1.35	1.75	0.054	0.068
D	0.35	0.49	0.014	0.019
F	0.40	1.25	0.016	0.049
G	1.27 BSC		0.050 BSC	
J	0.19	0.25	0.008	0.009
K	0.10	0.25	0.004	0.009
M	0°	7°	0°	7°
P	5.80	6.20	0.229	0.244
R	0.25	0.50	0.010	0.019

PACKAGE THERMAL DATA

Parameter		SOIC-16	Unit
R _{θJC}	Typical	28	°C/W
R _{θJA}	Typical	115	°C/W

CS51021A, CS51022A, CS51023A, CS51024A

TSSOP-16
CASE 948F-01
ISSUE A

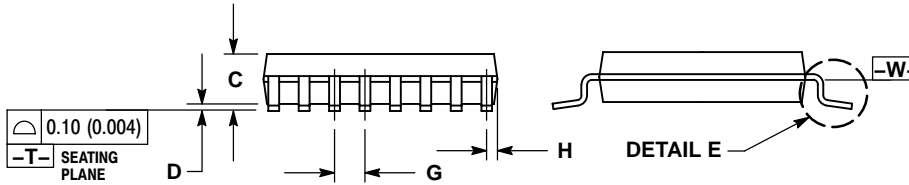
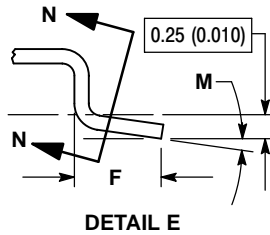
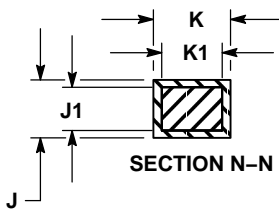
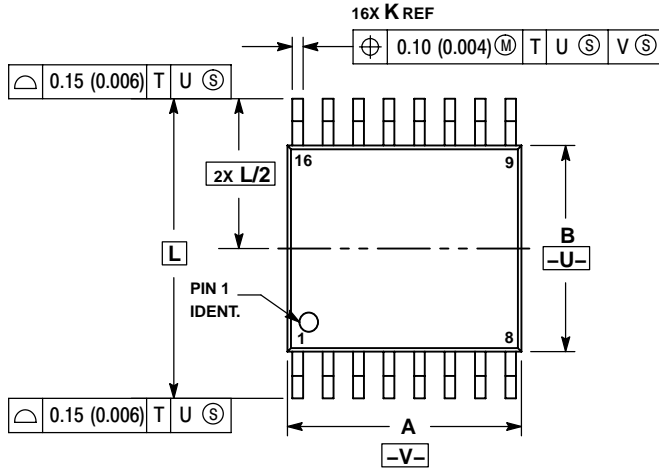

NOTES:

1. DIMENSIONING AND TOLERANCING PER ANSI Y14.5M, 1982.
2. CONTROLLING DIMENSION: MILLIMETER.
3. DIMENSION A DOES NOT INCLUDE MOLD FLASH, PROTRUSIONS OR GATE BURRS. MOLD FLASH OR GATE BURRS SHALL NOT EXCEED 0.15 (0.006) PER SIDE.
4. DIMENSION B DOES NOT INCLUDE INTERLEAD FLASH OR PROTRUSION. INTERLEAD FLASH OR PROTRUSION SHALL NOT EXCEED 0.25 (0.010) PER SIDE.
5. DIMENSION K DOES NOT INCLUDE DAMBAR PROTRUSION. ALLOWABLE DAMBAR PROTRUSION SHALL BE 0.08 (0.003) TOTAL IN EXCESS OF THE K DIMENSION AT MAXIMUM MATERIAL CONDITION.
6. TERMINAL NUMBERS ARE SHOWN FOR REFERENCE ONLY.
7. DIMENSION A AND B ARE TO BE DETERMINED AT DATUM PLANE -W-.

DIM	MILLIMETERS		INCHES	
	MIN	MAX	MIN	MAX
A	4.90	5.10	0.193	0.200
B	4.30	4.50	0.169	0.177
C	---	1.20	---	0.047
D	0.05	0.15	0.002	0.006
F	0.50	0.75	0.020	0.030
G	0.65 BSC		0.026 BSC	
H	0.18	0.28	0.007	0.011
J	0.09	0.20	0.004	0.008
J1	0.09	0.16	0.004	0.006
K	0.19	0.30	0.007	0.012
K1	0.19	0.25	0.007	0.010
L	6.40 BSC		0.252 BSC	
M	0° 8°		0° 8°	

ON Semiconductor and are registered trademarks of Semiconductor Components Industries, LLC (SCILLC). SCILLC reserves the right to make changes without further notice to any products herein. SCILLC makes no warranty, representation or guarantee regarding the suitability of its products for any particular purpose, nor does SCILLC assume any liability arising out of the application or use of any product or circuit, and specifically disclaims any and all liability, including without limitation special, consequential or incidental damages. "Typical" parameters which may be provided in SCILLC data sheets and/or specifications can and do vary in different applications and actual performance may vary over time. All operating parameters, including "Typicals" must be validated for each customer application by customer's technical experts. SCILLC does not convey any license under its patent rights nor the rights of others. SCILLC products are not designed, intended, or authorized for use as components in systems intended for surgical implant into the body, or other applications intended to support or sustain life, or for any other application in which the failure of the SCILLC product could create a situation where personal injury or death may occur. Should Buyer purchase or use SCILLC products for any such unintended or unauthorized application, Buyer shall indemnify and hold SCILLC and its officers, employees, subsidiaries, affiliates, and distributors harmless against all claims, costs, damages, and expenses, and reasonable attorney fees arising out of, directly or indirectly, any claim of personal injury or death associated with such unintended or unauthorized use, even if such claim alleges that SCILLC was negligent regarding the design or manufacture of the part. SCILLC is an Equal Opportunity/Affirmative Action Employer. This literature is subject to all applicable copyright laws and is not for resale in any manner.

PUBLICATION ORDERING INFORMATION

LITERATURE FULFILLMENT:

Literature Distribution Center for ON Semiconductor
P.O. Box 61312, Phoenix, Arizona 85082-1312 USA
Phone: 480-829-7710 or 800-344-3860 Toll Free USA/Canada
Fax: 480-829-7709 or 800-344-3867 Toll Free USA/Canada
Email: orderlit@onsemi.com

N. American Technical Support: 800-282-9855 Toll Free
USA/Canada

Japan: ON Semiconductor, Japan Customer Focus Center
2-9-1 Kamimeguro, Meguro-ku, Tokyo, Japan 153-0051
Phone: 81-3-5773-3850

ON Semiconductor Website: <http://onsemi.com>

Order Literature: <http://www.onsemi.com/litorder>

For additional information, please contact your local Sales Representative.