



2.2W, Low-EMI, Stereo, Class D Power Amplifiers with DirectDrive Headphone Amplifiers

General Description

The MAX9752/MAX9753/MAX9754 combine a high-efficiency, filterless, stereo Class D audio power amplifier with a DirectDrive™ headphone amplifier in a single device. The Class D amplifier operates from a single 4.5V to 5.5V supply and provides 2.2W per channel into a 4Ω load. The headphone amplifier operates from a single 3V to 5.5V supply, and uses Maxim's DirectDrive architecture to produce a ground-referenced output from a single supply.

The MAX9754 features a Class D stereo speaker amplifier and headphone driver. The MAX9752 adds an analog volume control and a BEEP input. The MAX9753 adds a stereo 2:1 input multiplexer. All devices feature logic-selectable gain, and a headphone sense input that detects the presence of a headphone.

The MAX9752/MAX9753/MAX9754 come in 28-pin thin QFN (5mm x 5mm x 0.8mm) packages, and are specified over the extended -40°C to +85°C temperature range. For a pin-for-pin-compatible Class AB version of these devices, refer to the MAX9750/MAX9751/MAX9755 data sheet.

Applications

Notebook PCs	Flat-Panel TVs
Tablet PCs	PC Displays
Portable DVDs	LCD Projectors

Pin Configurations appear at end of data sheet.

Features

- ◆ PC2001 Compliant
- ◆ 2.2W Class D Stereo Speaker Amplifier
- ◆ Pin-for-Pin Compatible with Class AB MAX9750/MAX9751/MAX9755
- ◆ 85% Efficiency ($R_L = 8\Omega$, $P_{OUT} = 1W$)
- ◆ 62mW DirectDrive Headphone Amplifier
- ◆ High PSRR (70dB at 1kHz)
- ◆ Analog Volume Control (MAX9752)
- ◆ Beep Input with Glitch Filter (MAX9752)
- ◆ 2:1 Stereo Input MUX (MAX9753)
- ◆ $\pm 8kV$ ESD-Protected Headphone Outputs
- ◆ No Output DC-Blocking Capacitors
- ◆ Industry-Leading Click-and-Pop Suppression

Ordering Information

PART	PIN-PACKAGE	PKG CODE	MAXIMUM GAIN (dB)
MAX9752AETI+	28 TQFN-EP*	T2855-1	13.5
MAX9752BETI+	28 TQFN-EP*	T2855-1	19.5
MAX9752CETI+	28 TQFN-EP*	T2855-1	10.5
MAX9753ETI+	28 TQFN-EP*	T2855-1	13.5
MAX9754ETI+	28 TQFN-EP*	T2855-1	13.5

Note: All devices specified for -40°C to +85°C operation.

+Denotes lead-free package.

*EP = Exposed paddle.

Block Diagrams

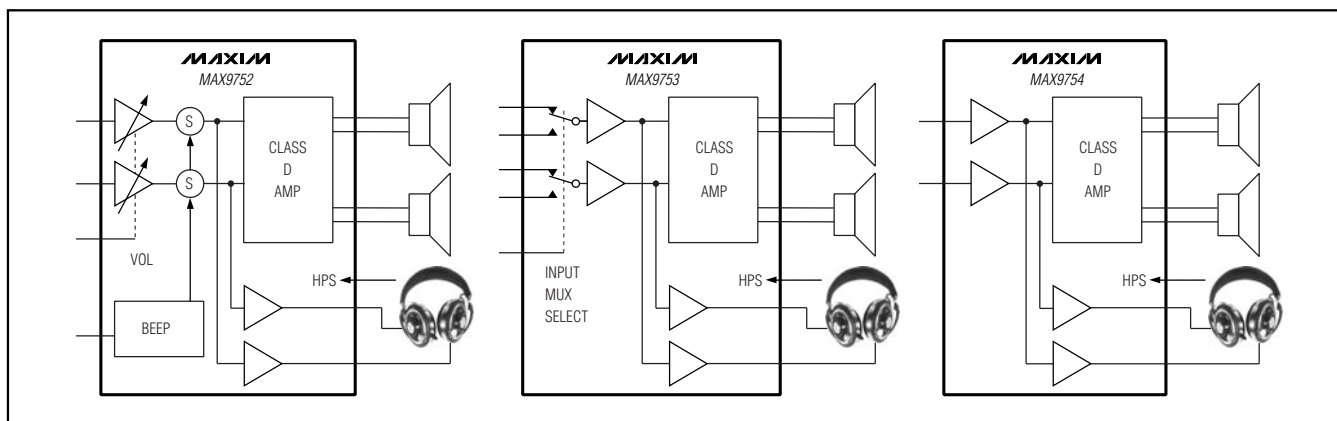

2.2W, Low-EMI, Stereo, Class D Power Amplifiers with DirectDrive Headphone Amplifiers

ABSOLUTE MAXIMUM RATINGS

V_{DD}, PV_{DD}, HPV_{DD}, CPV_{DD} to GND -0.3V to +6V
 GND to PGND or CPGND -0.3V to +0.3V
 CPV_{SS} or V_{SS} to PGND -6.0V to +0.3V
 C1N to PGND (CPV_{SS} - 0.3V) to +0.3V
 C1P to PGND -0.3V to (CPV_{DD} + 0.3V)
 HP₋ to PGND (HPV_{SS} - 0.3V) to (HPV_{DD} + 0.3V)
 HP₋ to PGND -3V to +3V
 Any Other Pin to PGND -0.3V to (V_{DD} + 0.3V)
 Duration of OUT₋ Short Circuit to PGND or PV_{DD} Continuous
 Duration of OUT₊ Short Circuit to OUT₋ Continuous
 Duration of HP₋ Short Circuit to PGND Continuous

Continuous Current Into/Out of PV_{DD}, OUT₋, PGND 1.7A
 Continuous Current Into/Out of CPV_{DD}, C1N, CPGND,
 C1P, CPV_{SS}, V_{SS}, HPV_{DD}, HP₋ 0.85A
 Continuous Input Current (all other pins) ±20mA
 Continuous Power Dissipation (T_A = +70°C)
 28-Pin TQFN (derate 21.3mW/°C above +70°C) 1702mW
 Operating Temperature Range -40°C to +85°C
 Storage Temperature Range -65°C to +150°C
 Junction Temperature +150°C
 Lead Temperature (soldering, 10s) +300°C

Stresses beyond those listed under "Absolute Maximum Ratings" may cause permanent damage to the device. These are stress ratings only, and functional operation of the device at these or any other conditions beyond those indicated in the operational sections of the specifications is not implied. Exposure to absolute maximum rating conditions for extended periods may affect device reliability.

ELECTRICAL CHARACTERISTICS

(V_{DD} = PV_{DD} = HPV_{DD} = CPV_{DD} = +5.0V, GND = PGND = HPGND = 0V, V_{SHDN} = V_{DD}, CPV_{SS} = V_{SS}, C_{BIAS} = 1μF, C_{CPVSS} = 1μF, C1 = 1μF, speaker impedance = 8Ω connected between OUT₊ and OUT₋, headphone load is terminated to GND; MAX9752: GAIN1 = GAIN2 = 0, V_{VOL} = 0V; MAX9753: GAIN = 0, V_{A/B} = 0V; MAX9754: GAIN = 0; T_A = T_{MIN} to T_{MAX}, unless otherwise noted. Typical values are at T_A = +25°C.) (Notes 1, 2)

PARAMETER	SYMBOL	CONDITIONS	MIN	TYP	MAX	UNITS
GENERAL						
Supply Voltage Range, Speaker Amplifier	V _{DD} , PV _{DD}	Inferred from PSRR test	4.5		5.5	V
Supply Voltage Range, Headphone Amplifier	HPV _{DD}	Inferred from PSRR test	3.0		5.5	V
Quiescent Current	I _{DD}	Speaker mode, no load		14	18	mA
		Headphone mode, no load		7.2	9.5	
Shutdown Supply Current	I _{SHDN}	V _{SHDN} = 0V		0.2	8	μA
Gain Switching Time	t _{SWG}			3		μs
Mux Switching Time	t _{SWM}	MAX9753 only		3		μs
Input Resistance	R _{IN}	MAX9752	10	20	30	kΩ
		MAX9753/MAX9754	3.5	6.6	10.0	
Turn-On Time	t _{ON}			25		ms
CLASS D SPEAKER AMPLIFIERS (HPS = GND)						
Output Offset Voltage OUT ₊ to OUT ₋	V _{OS}	MAX9752A, MAX9752B, MAX9753, MAX9754	T _A = +25°C	±9.6	±38.8	mV
			T _A = T _{MIN} to T _{MAX}		±55	
		MAX9752C	T _A = +25°C	±7	±40	
			T _A = T _{MIN} to T _{MAX}		±60	
Power-Supply Rejection Ratio (Note 3)	PSRR	PV _{DD} or V _{DD} = 4.5V to 5.5V, T _A = +25°C	50	74	dB	
		f = 1kHz, V _{RIPPLE} = 100mV _{P-P}		70		
		f = 10kHz, V _{RIPPLE} = 100mV _{P-P}		60		

2.2W, Low-EMI, Stereo, Class D Power Amplifiers with DirectDrive Headphone Amplifiers

ELECTRICAL CHARACTERISTICS (continued)

($V_{DD} = PV_{DD} = HPV_{DD} = CPV_{DD} = +5.0V$, $GND = PGND = HPGND = 0V$, $V_{SHDN} = V_{DD}$, $CPV_{SS} = V_{SS}$, $C_{BIAS} = 1\mu F$, $C_{CPVSS} = 1\mu F$, $C1 = 1\mu F$, speaker impedance = 8Ω connected between OUT_+ and OUT_- , headphone load is terminated to GND ; MAX9752: $GAIN1 = GAIN2 = 0$, $V_{VOL} = 0V$; MAX9753: $GAIN = 0$, $V_{A/B} = 0V$; MAX9754: $GAIN = 0$; $T_A = T_{MIN}$ to T_{MAX} , unless otherwise noted. Typical values are at $T_A = +25^\circ C$.) (Notes 1, 2)

PARAMETER	SYMBOL	CONDITIONS		MIN	TYP	MAX	UNITS
Speaker Amplifier Gain (Note 4)	A_{V_SP}	MAX9752A	GAIN2 = 0, GAIN1 = 0		9.0		dB
			GAIN2 = 0, GAIN1 = 1		10.5		
			GAIN2 = 1, GAIN1 = 0		12.0		
			GAIN2 = 1, GAIN1 = 1		13.5		
		MAX9752B	GAIN2 = 0, GAIN1 = 0		15.0		
			GAIN2 = 0, GAIN1 = 1		16.5		
			GAIN2 = 1, GAIN1 = 0		18.0		
			GAIN2 = 1, GAIN1 = 1		19.5		
		MAX9752C	GAIN2 = 0, GAIN1 = 0		6.0		
			GAIN2 = 0, GAIN1 = 1		7.5		
			GAIN2 = 1, GAIN1 = 0		9.0		
			GAIN2 = 1, GAIN1 = 1		10.5		
		MAX9753/MAX9754	GAIN = 1		9.0		
			GAIN = 0		10.5		
Output Power	P_{OUT_SP}	f = 1kHz, THD+N = 1%, $T_A = +25^\circ C$, $R_L = 8\Omega$	MAX9752A, MAX9752B, MAX9753, MAX9754		1.3		W
			MAX9752C		0.8		
		f = 1kHz, THD+N = 1%, $T_A = +25^\circ C$, $R_L = 4\Omega$	MAX9752A, MAX9752B, MAX9753, MAX9754		2.2		
			MAX9752C		1.7		
Total Harmonic Distortion Plus Noise	THD+N	f = 1kHz, $P_{OUT} = 1W$	$R_L = 8\Omega$		0.023		%
			$R_L = 4\Omega$		0.03		
Signal-to-Noise Ratio	SNR	$P_{OUT} = 1W$, f = 1kHz, BW = 22Hz to 22kHz	Unweighted		90		dB
			A-weighted		91		
Click-and-Pop Level (Note 5)	K_{CP}	Into shutdown			-47		dBV
		Out of shutdown			-34		
Capacitive-Load Drive	C_{L_MAX}	Differential			200		pF
Switching Frequency	f_{SW}			1000	1200	1400	kHz
Crosstalk		Channel to channel, f = 10kHz, $P_{OUT} = 1W$			70		dB
Off-Isolation		MAX9753, unselected input to any active input, f = 10kHz			70		dB
Efficiency	η	$R_L = 8\Omega$, $P_{OUT} = 1W$, f = 1kHz			85		%

MAX9752/MAX9753/MAX9754

2.2W, Low-EMI, Stereo, Class D Power Amplifiers with DirectDrive Headphone Amplifiers

ELECTRICAL CHARACTERISTICS (continued)

($V_{DD} = PV_{DD} = HPV_{DD} = CPV_{DD} = +5.0V$, $GND = PGND = HPGND = 0V$, $V_{SHDN} = V_{DD}$, $CPV_{SS} = V_{SS}$, $C_{BIAS} = 1\mu F$, $CCP_{VSS} = 1\mu F$, $C1 = 1\mu F$, speaker impedance = 8Ω connected between OUT_{+} and OUT_{-} , headphone load is terminated to GND; MAX9752: $GAIN1 = GAIN2 = 0$, $V_{VOL} = 0V$; MAX9753: $GAIN = 0$, $V_{A/B} = 0V$; MAX9754: $GAIN = 0$; $T_A = T_{MIN}$ to T_{MAX} , unless otherwise noted. Typical values are at $T_A = +25^{\circ}C$.) (Notes 1, 2)

PARAMETER	SYMBOL	CONDITIONS		MIN	TYP	MAX	UNITS
HEADPHONE AMPLIFIER (HPS = V_{DD})							
Output Offset Voltage	V_{OS}	$T_A = +25^{\circ}C$			± 0.5	± 3.5	mV
		$T_A = T_{MIN}$ to T_{MAX}				± 8	
Maximum Headphone Amplifier Gain (Note 6)	$A_{V_{HP}}$	MAX9752, GAIN1 = don't care	GAIN2 = 0		0		dB
			GAIN2 = 1		3		
		MAX9753/MAX9754	GAIN = 1		0		
			GAIN = 0		3		
Power-Supply Rejection Ratio (Note 3)	PSRR	HPV _{DD} or $V_{DD} = 3V$ to $5.5V$, $T_A = +25^{\circ}C$		66	73		dB
		$f = 1kHz$, $V_{RIPPLE} = 100mV_{p-p}$			80		
		$f = 10kHz$, $V_{RIPPLE} = 100mV_{p-p}$			60		
Output Power	$P_{OUT_{HP}}$	THD+N = 1%, $f_{IN} = 1kHz$, $T_A = +25^{\circ}C$	$R_L = 32\Omega$		31		mW
			$R_L = 16\Omega$		62		
Total Harmonic Distortion Plus Noise	THD+N	$f_{IN} = 1kHz$	$R_L = 32\Omega$, $P_{OUT} = 31mW$		0.005		%
			$R_L = 16\Omega$, $P_{OUT} = 62mW$		0.005		
Signal-to-Noise Ratio	SNR	$R_L = 32\Omega$, $P_{OUT} = 31mW$, $f_{IN} = 1kHz$, BW = 22Hz to 22kHz	Unweighted		95		dB
			A-weighted		101		
Click-and-Pop Level (Note 7)	K_{CP}	Into shutdown			-33		dBV
		Out of shutdown			-37		
Capacitive-Load Drive	$C_{L_{MAX}}$	No sustained oscillations			300		pF
Crosstalk		$f = 10kHz$, $P_{OUT} = 62mW$, $R_L = 16\Omega$			60		dB
Off-Isolation		MAX9753, unselected input to any active input, $f = 10kHz$			60		dB
Slew Rate	SR				0.8		V/ μs
Output Impedance		HPS = GND (disabled)			1		k Ω
CHARGE PUMP							
Charge-Pump Frequency	f_{CP}			540	600	660	kHz
VOLUME CONTROL (MAX9752 Only)							
VOL Input Impedance	R_{VOL}				100		M Ω
VOL Input Hysteresis	$HYST_{VOL}$	V_{VOL} falling			50		mV
Full Mute Input Voltage	$V_{VOL_{MUTE}}$				$0.858 \times V_{DD}$		V
Full Mute Attenuation	$A_{V_{MUTE}}$	$f_{IN} = 1kHz$			-85		dB

2.2W, Low-EMI, Stereo, Class D Power Amplifiers with DirectDrive Headphone Amplifiers

MAX9752/MAX9753/MAX9754

ELECTRICAL CHARACTERISTICS (continued)

($V_{DD} = PV_{DD} = HPV_{DD} = CPV_{DD} = +5.0V$, $GND = PGND = HPGND = 0V$, $V_{\overline{SHDN}} = V_{DD}$, $CPV_{SS} = V_{SS}$, $C_{BIAS} = 1\mu F$, $C_{CPV_{SS}} = 1\mu F$, $C_1 = 1\mu F$, speaker impedance = 8Ω connected between OUT_+ and OUT_- , headphone load is terminated to GND; MAX9752: $GAIN_1 = GAIN_2 = 0$, $V_{VOL} = 0V$; MAX9753: $GAIN = 0$, $V_{\overline{A/B}} = 0V$; MAX9754: $GAIN = 0$; $T_A = T_{MIN}$ to T_{MAX} , unless otherwise noted. Typical values are at $T_A = +25^\circ C$.) (Notes 1, 2)

PARAMETER	SYMBOL	CONDITIONS	MIN	TYP	MAX	UNITS
Channel Matching		Gain 10.5dB to 13.5dB		± 0.2		dB
		Gain 6.0dB to 10.0dB		± 0.2		
		Gain -26dB to +4.0dB		± 0.3		
		Gain -62dB to +30dB		± 1.0		
BEEP INPUT (MAX9752 Only)						
Beep Signal Minimum Amplitude (Note 8)	V_{BEEP}	$R_{BEEP} = 47k\Omega$	400			mV
Beep Signal Minimum Frequency	f_{BEEP}		300			Hz
LOGIC INPUTS ($GAIN_+$, $IN1/\overline{2}$, \overline{SHDN}, HPS)						
Input High Voltage	V_{IH}		2.0			V
Input Low Voltage	V_{IL}				0.8	V
Input Leakage Current	I_{LEAK}	$GAIN_+$, \overline{SHDN}	-1		+1	μA
		$IN1/\overline{2}$	-2		+2	
		HPS	-20		+1	

Note 1: All devices are 100% production tested at $T_A = +25^\circ C$. All temperature limits are guaranteed by design.

Note 2: Speaker amplifier testing performed with a resistive load in series with an inductor to simulate an actual speaker load. For $R_L = 4\Omega$, $L = 33\mu H$. For $R_L = 8\Omega$, $L = 68\mu H$.

Note 3: Measured with the amplifier input connected to GND through C_{IN} .

Note 4: Speaker amplifier gain is defined as $A = (V_{OUT_+} - V_{OUT_-}) / V_{IN_-}$.

Note 5: Testing performed with 8Ω resistive load in series with $68\mu H$ inductive load connected across the BTL output. Mode transitions are controlled by \overline{SHDN} . Peak reading, THD+N = 1%, A-weighted, 32 samples per second. K_{CP} level is calculated as:
 $20 \times \log[(\text{peak voltage under normal operation at rated power level}) / (\text{peak voltage during mode transition, no input signal})]$.

Note 6: Headphone amplifier gain is defined as $A = V_{HP_-} / V_{IN_-}$.

Note 7: Testing performed with 32Ω resistive load connected from HP_- output to GND. Mode transitions are controlled by \overline{SHDN} . Peak reading, THD+N = 1%, A-weighted, 32 samples per second. K_{CP} level is calculated as:
 $20 \times \log[(\text{peak voltage under normal operation at rated power level}) / (\text{peak voltage during mode transition, no input signal})]$.

Note 8: The value of R_{BEEP} dictates the minimum beep signal amplitude that is detected (see the *Beep Input (MAX9752)* section).

2.2W, Low-EMI, Stereo, Class D Power Amplifiers with DirectDrive Headphone Amplifiers

Typical Operating Characteristics

($V_{DD} = P_{VDD} = HP_{VDD} = CP_{VDD} = 5.0V$, $GND = PGND = HPGND = 0V$, $V_{SHDN} = V_{DD}$, $CP_{VSS} = V_{SS}$, $C_{BIAS} = 1\mu F$, $CC_{VSS} = 1\mu F$, $C1 = 1\mu F$, speaker impedance = 8Ω connected between OUT_{+} and OUT_{-} , headphone load is terminated to GND ; MAX9752: $GAIN1 = GAIN2 = 0$, $V_{VOL} = 0V$; MAX9753: $GAIN = 0$, $V_{AB} = 0V$; MAX9754: $GAIN = 0$; $T_A = +25^{\circ}C$, unless otherwise noted.)

TOTAL HARMONIC DISTORTION PLUS NOISE vs. FREQUENCY (SPEAKER MODE)

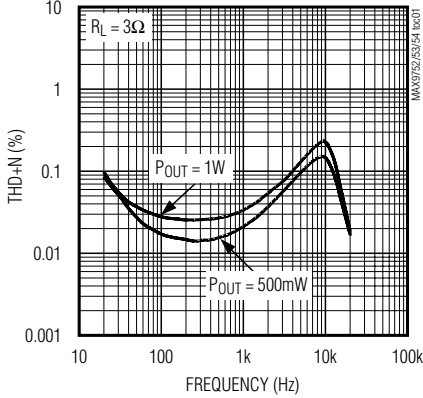

TOTAL HARMONIC DISTORTION PLUS NOISE vs. FREQUENCY (SPEAKER MODE)

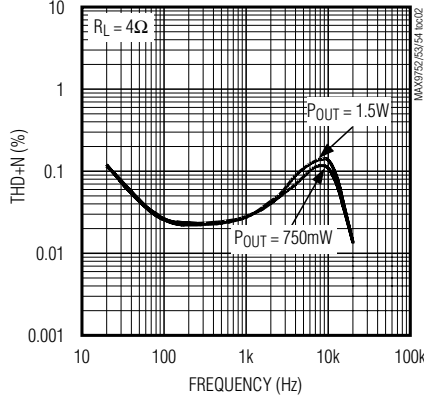

TOTAL HARMONIC DISTORTION PLUS NOISE vs. FREQUENCY (SPEAKER MODE)

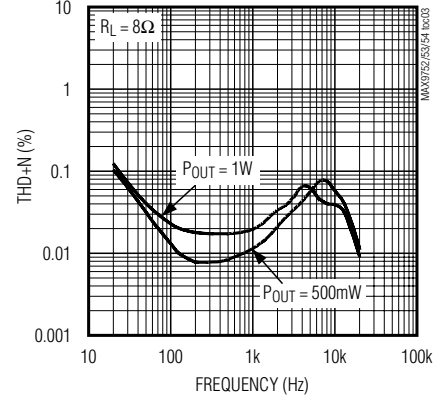

TOTAL HARMONIC DISTORTION PLUS NOISE vs. OUTPUT POWER

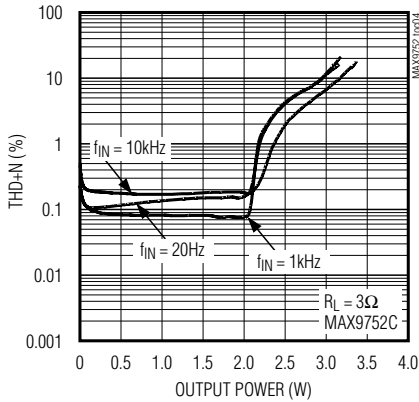

TOTAL HARMONIC DISTORTION PLUS NOISE vs. OUTPUT POWER

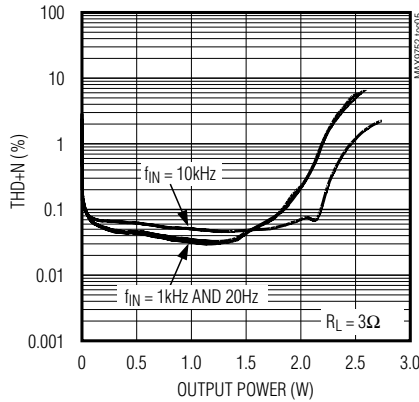

TOTAL HARMONIC DISTORTION PLUS NOISE vs. OUTPUT POWER

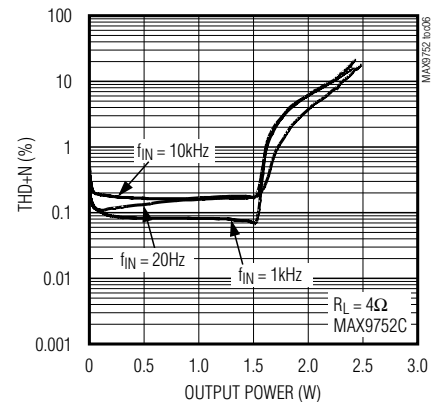

TOTAL HARMONIC DISTORTION PLUS NOISE vs. OUTPUT POWER

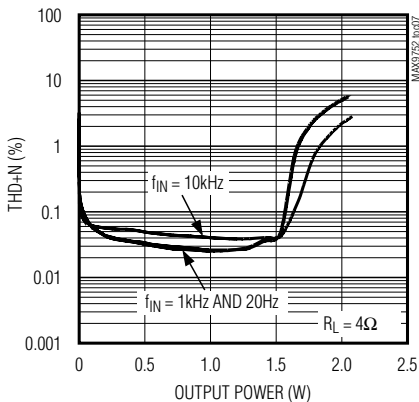

TOTAL HARMONIC DISTORTION PLUS NOISE vs. OUTPUT POWER

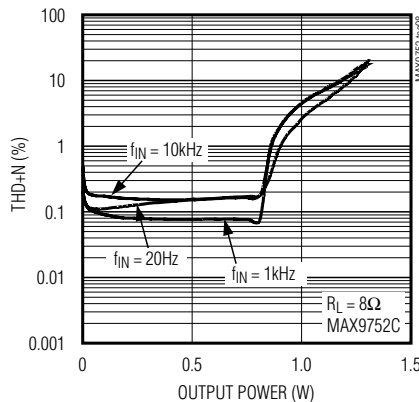

TOTAL HARMONIC DISTORTION PLUS NOISE vs. OUTPUT POWER

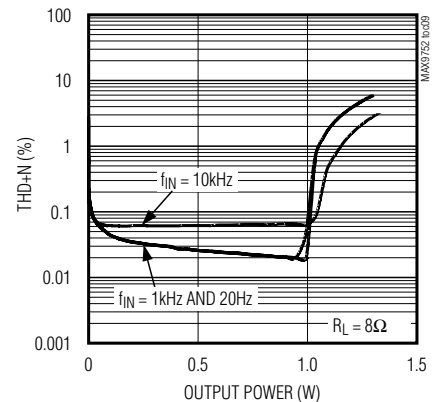

2.2W, Low-EMI, Stereo, Class D Power Amplifiers with DirectDrive Headphone Amplifiers

MAX9752/MAX9753/MAX9754

Typical Operating Characteristics (continued)

($V_{DD} = PV_{DD} = HPV_{DD} = CPV_{DD} = 5.0V$, $GND = PGND = HPGND = 0V$, $V_{SHDN} = V_{DD}$, $CPV_{SS} = V_{SS}$, $C_{BIAS} = 1\mu F$, $C_{CPV_{SS}} = 1\mu F$, $C1 = 1\mu F$, speaker impedance = 8Ω connected between OUT_{+} and OUT_{-} , headphone load is terminated to GND ; MAX9752: $GAIN1 = GAIN2 = 0$, $V_{VOL} = 0V$; MAX9753: $GAIN = 0$, $V_{AB} = 0V$; MAX9754: $GAIN = 0$; $T_A = +25^{\circ}C$, unless otherwise noted.)

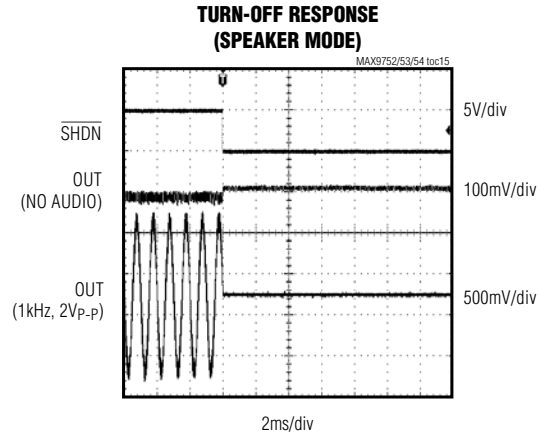
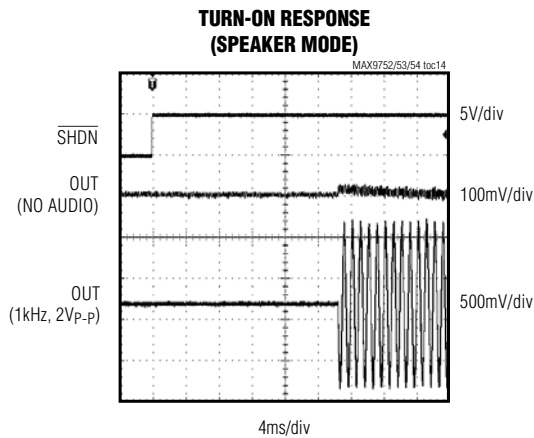
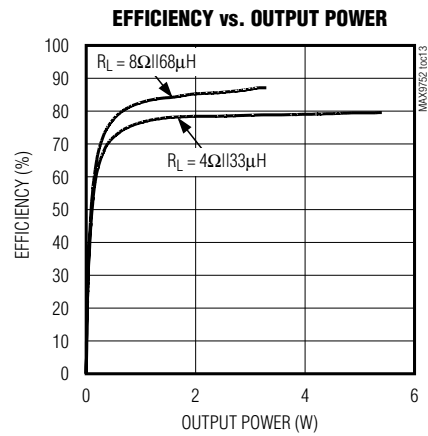
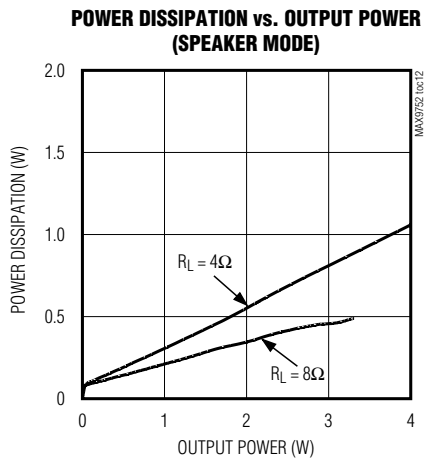
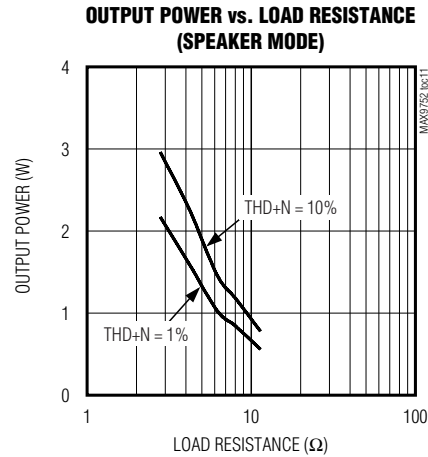
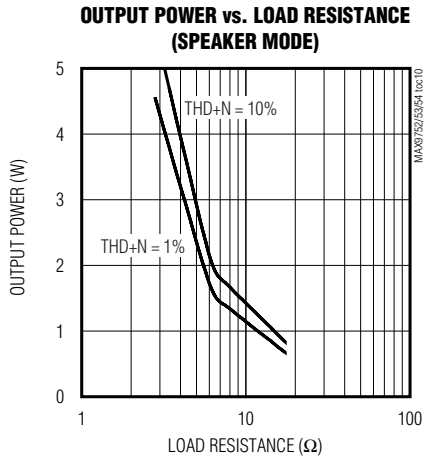

2.2W, Low-EMI, Stereo, Class D Power Amplifiers with DirectDrive Headphone Amplifiers

Typical Operating Characteristics (continued)

($V_{DD} = PV_{DD} = HPV_{DD} = CPV_{DD} = 5.0V$, $GND = PGND = HPGND = 0V$, $V_{SHDN} = V_{DD}$, $CPV_{SS} = V_{SS}$, $C_{BIAS} = 1\mu F$, $CCP_{SS} = 1\mu F$, $C1 = 1\mu F$, speaker impedance = 8Ω connected between OUT_{+} and OUT_{-} , headphone load is terminated to GND ; MAX9752: $GAIN1 = GAIN2 = 0$, $V_{VOL} = 0V$; MAX9753: $GAIN = 0$, $V_{AB} = 0V$; MAX9754: $GAIN = 0$; $T_A = +25^{\circ}C$, unless otherwise noted.)

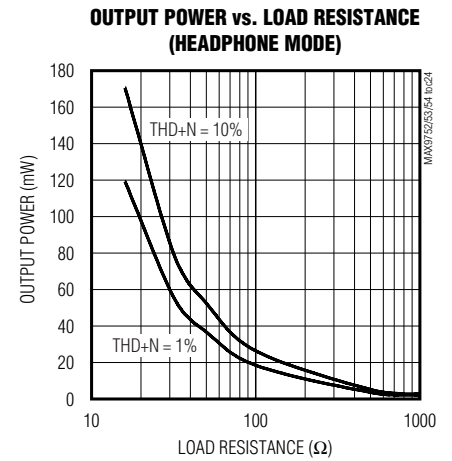
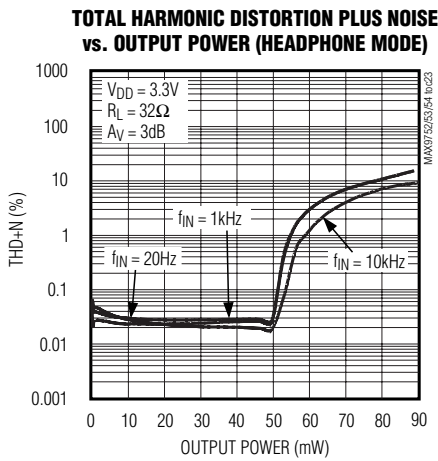
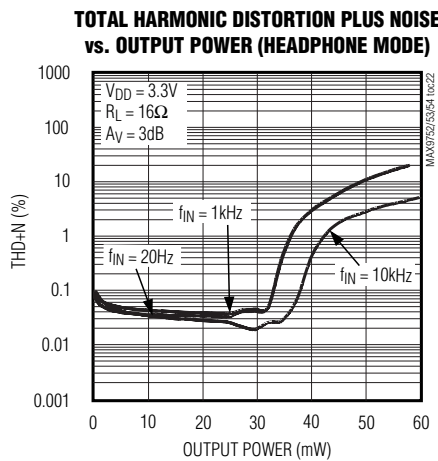
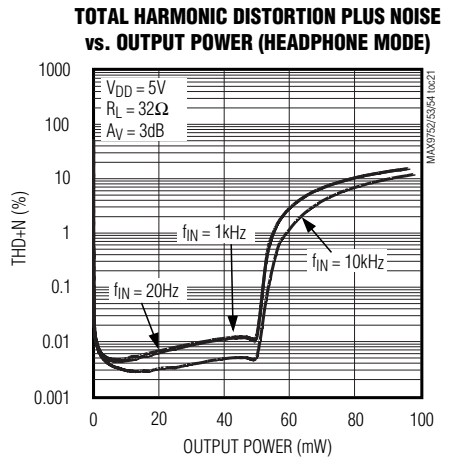
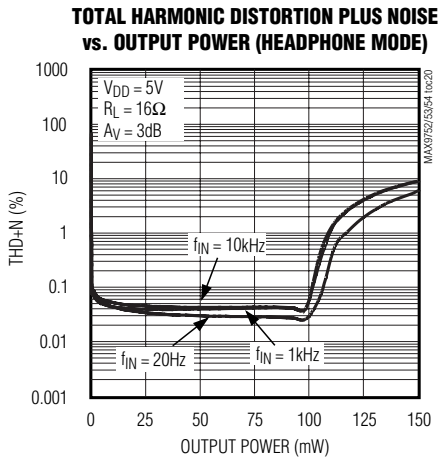
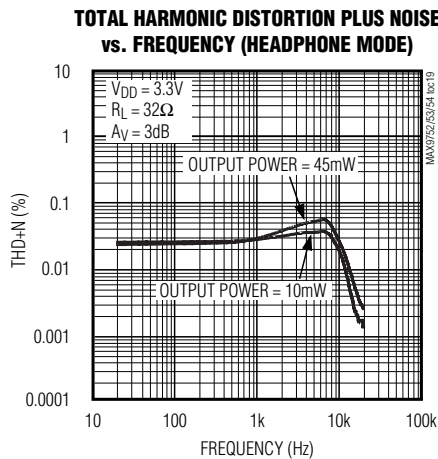
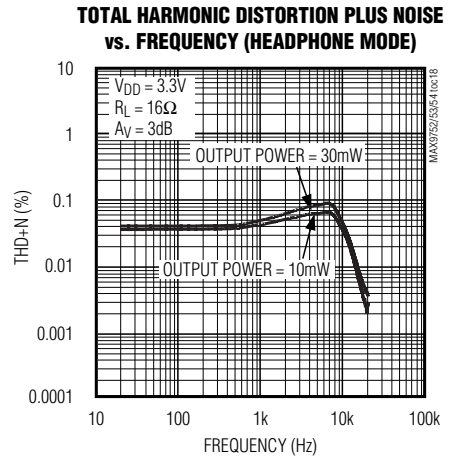
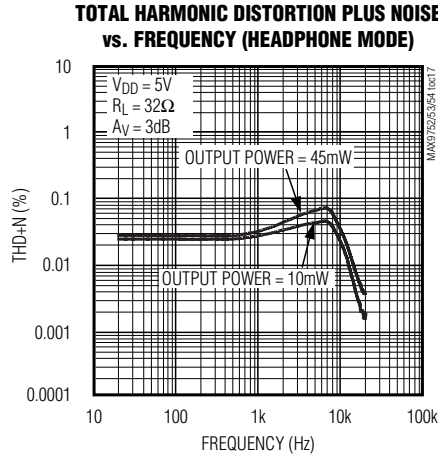
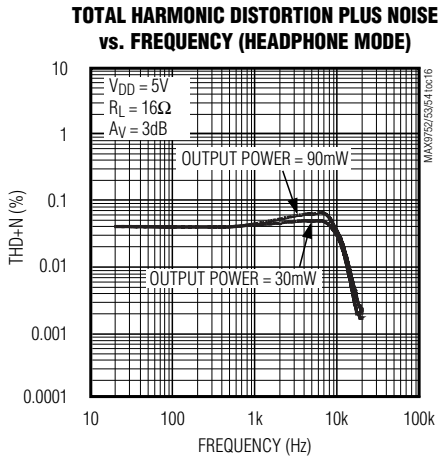

2.2W, Low-EMI, Stereo, Class D Power Amplifiers with DirectDrive Headphone Amplifiers

Typical Operating Characteristics (continued)

($V_{DD} = PV_{DD} = HPV_{DD} = CPV_{DD} = 5.0V$, $GND = PGND = HPGND = 0V$, $V_{SHDN} = V_{DD}$, $CPV_{SS} = V_{SS}$, $C_{BIAS} = 1\mu F$, $CCPV_{SS} = 1\mu F$, $C1 = 1\mu F$, speaker impedance = 8Ω connected between OUT_{+} and OUT_{-} , headphone load is terminated to GND ; MAX9752: $GAIN1 = GAIN2 = 0$, $V_{VOL} = 0V$; MAX9753: $GAIN = 0$, $V_{AB} = 0V$; MAX9754: $GAIN = 0$; $T_A = +25^{\circ}C$, unless otherwise noted.)

POWER DISSIPATION vs. OUTPUT POWER (HEADPHONE MODE)

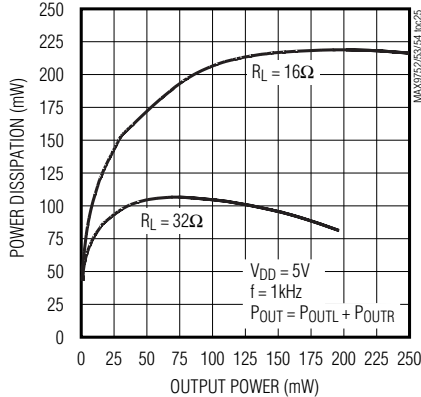

OUTPUT POWER vs. SUPPLY VOLTAGE (HEADPHONE MODE)

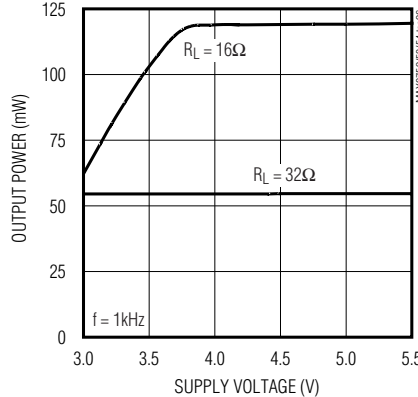

POWER-SUPPLY REJECTION RATIO vs. FREQUENCY (HEADPHONE MODE)

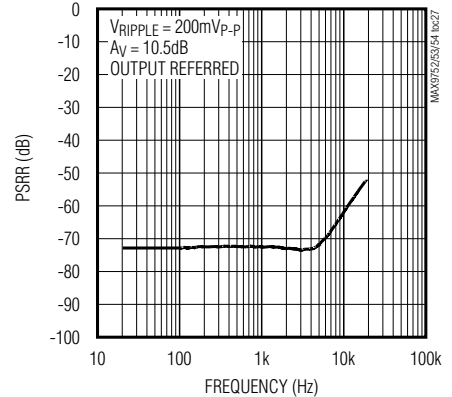

CROSSTALK vs. FREQUENCY (HEADPHONE MODE)

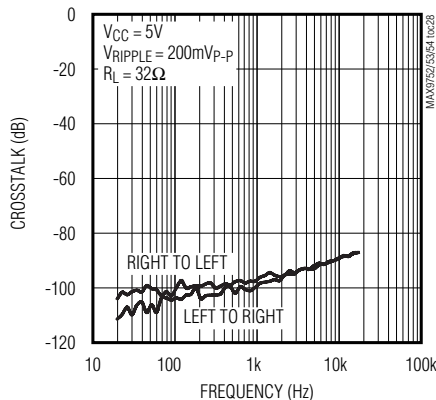

OUTPUT POWER vs. CHARGE-PUMP CAPACITANCE AND LOAD RESISTANCE

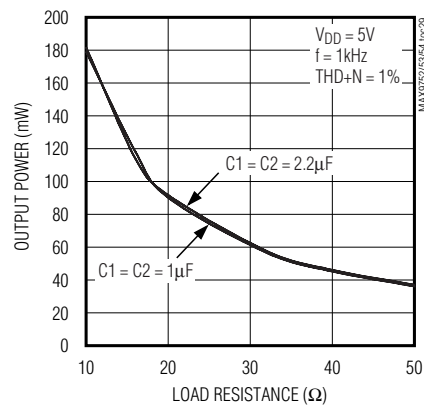

MAX9752/MAX9753/MAX9754

2.2W, Low-EMI, Stereo, Class D Power Amplifiers with DirectDrive Headphone Amplifiers

Typical Operating Characteristics (continued)

($V_{DD} = PV_{DD} = HPV_{DD} = CPV_{DD} = 5.0V$, $GND = PGND = HPGND = 0V$, $V_{SHDN} = V_{DD}$, $CPV_{SS} = V_{SS}$, $C_{BIAS} = 1\mu F$, $C_{CPVSS} = 1\mu F$, $C1 = 1\mu F$, speaker impedance = 8Ω connected between OUT_{+} and OUT_{-} , headphone load is terminated to GND; MAX9752: $GAIN1 = GAIN2 = 0$, $V_{VOL} = 0V$; MAX9753: $GAIN = 0$, $V_{AB} = 0V$; MAX9754: $GAIN = 0$; $T_A = +25^{\circ}C$, unless otherwise noted.)

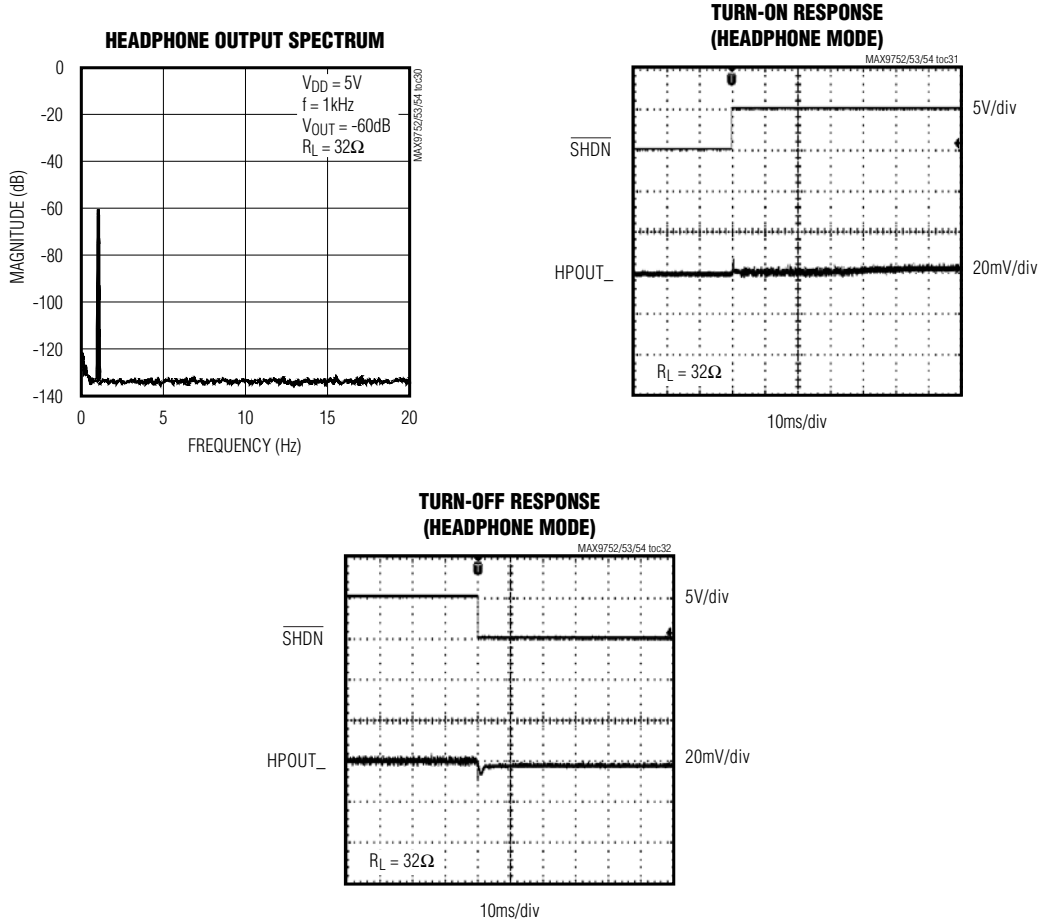

2.2W, Low-EMI, Stereo, Class D Power Amplifiers with DirectDrive Headphone Amplifiers

Pin Descriptions

MAX9752/MAX9753/MAX9754

PIN			NAME	FUNCTION
MAX9752	MAX9753	MAX9754		
1	—	2	INL	Left-Channel Audio Input
2	—	—	BEEP	Audible Alert Beep Input
3, 19	3, 19	3, 19	PGND	Power Ground
4	4	4	OUTL+	Left-Channel Positive Speaker Output
5	5	5	OUTL-	Left-Channel Negative Speaker Output
6, 16	6, 16	6, 16	PVDD	Speaker Amplifier Power Supply
7	7	7	CPVDD	Charge-Pump Power Supply
8	8	8	C1P	Charge-Pump Flying-Capacitor Positive Terminal
9	9	9	CPGND	Charge-Pump Ground
10	10	10	C1N	Charge-Pump Flying-Capacitor Negative Terminal
11	11	11	CPVSS	Charge-Pump Output. Connect to VSS.
12	12	12	VSS	Headphone Amplifier Negative Power Supply
13	13	13	HPOUTR	Right-Channel Headphone Output
14	14	14	HPOUTL	Left-Channel Headphone Output
15	15	15	HPVDD	Headphone Positive Power Supply
17	17	17	OUTR-	Right-Channel Negative Speaker Output
18	18	18	OUTR+	Right-Channel Positive Speaker Output
20	20	20	HPS	Headphone Sense Input
21	21	21	BIAS	Common-Mode Bias Voltage. Bypass with a 1 μ F capacitor to GND.
22	22	22	$\overline{\text{SHDN}}$	Shutdown. Drive $\overline{\text{SHDN}}$ low to disable the device. Connect $\overline{\text{SHDN}}$ to VDD for normal operation.
23	—	—	GAIN2	Gain-Control Input 2
24	—	—	GAIN1	Gain-Control Input 1
25	25	25	VDD	Power Supply
26	26	23, 26	GND	Ground
27	—	28	INR	Right-Channel Audio Input
28	—	—	VOL	Analog Volume Control Input
—	1	—	INL1	Left-Channel Audio Input 1
—	2	—	INL2	Left-Channel Audio Input 2
—	23	—	IN1/2	Input Select
—	24	24	GAIN	Gain Select
—	27	—	INR1	Right-Channel Audio Input 1
—	28	—	INR2	Right-Channel Audio Input 2
—	—	1, 27	N.C.	No Connection. Not internally connected.

2.2W, Low-EMI, Stereo, Class D Power Amplifiers with DirectDrive Headphone Amplifiers

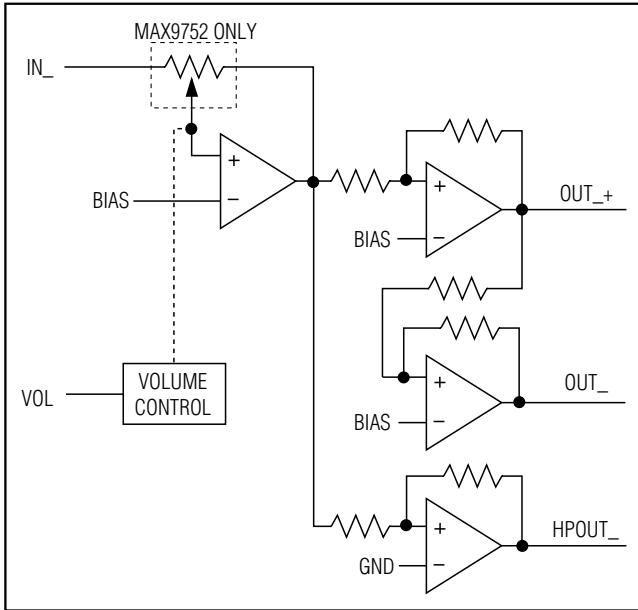

Figure 1. MAX9752/MAX9753/MAX9754 Signal Path

Detailed Description

The MAX9752/MAX9753/MAX9754 combine a 2.2W, Class D speaker amplifier and a 62mW DirectDrive headphone amplifier with integrated headphone sensing and comprehensive click-and-pop suppression. The speaker amplifiers offer Class AB performance with Class D efficiency, while occupying minimal board space. A unique filterless modulation scheme and spread-spectrum switching create a compact, flexible, low-noise, efficient audio power amplifier.

The MAX9752 features an analog volume control, BEEP input, and four-level gain control. The MAX9753 features a 2:1 input stereo multiplexer and two-level gain control. The MAX9754 has only the Class D amplifiers and the headphone amplifiers.

An input amplifier sets the gain of the signal path, and feeds both the speaker and headphone amplifier (Figure 1). The speaker amplifier uses a low-EMI, Class D architecture to drive the speakers, eliminating the need for an external filter for short speaker cables.

The headphone amplifiers use Maxim's DirectDrive architecture eliminating the bulky output DC-blocking capacitors required by traditional headphone amplifiers. A charge pump inverts the positive supply (CPVDD), creating a negative supply (CPVSS). The headphone amplifiers operate from these bipolar supplies with their outputs biased about GND (Figure 2). The amplifiers

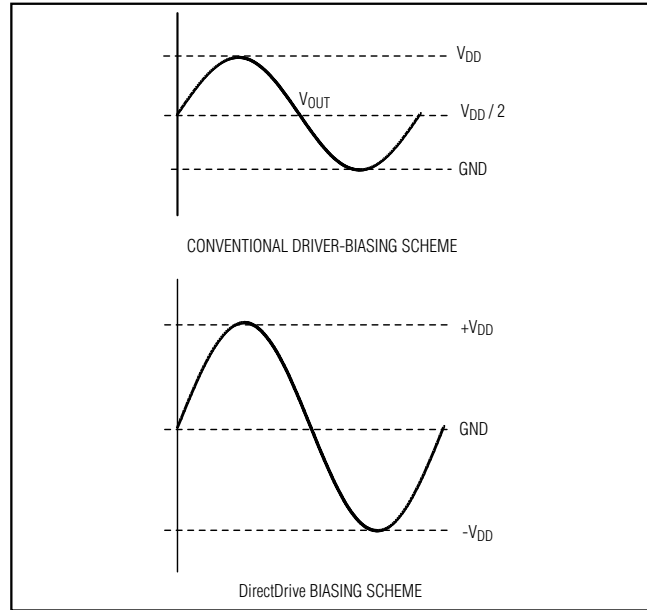

Figure 2. Traditional Amplifier Output vs. DirectDrive Output

have almost twice the supply range compared to other single-supply amplifiers, nearly quadrupling the available output power. The benefit of the GND bias is that the amplifier outputs no longer have a DC component (typically $V_{DD} / 2$). This eliminates the large DC-blocking capacitors required with conventional headphone amplifiers, removing the dominant source of click and pop, conserving board space, system cost, and improving frequency response.

An undervoltage lockout prevents operation from an insufficient power supply. The amplifiers include thermal-overload and short-circuit protection, and can withstand $\pm 8\text{kV}$ ESD strikes on the headphone amplifier outputs (IEC Air-Gap Discharge). An additional feature of the speaker amplifiers is that there is no phase inversion from input to output.

Class D Speaker Amplifier

The MAX9752/MAX9753/MAX9754 feature a unique spread-spectrum mode that flattens the wideband spectral components, improving EMI emissions that may be radiated by the speaker and cables. The switching frequency varies randomly by $\pm 90\text{kHz}$ around the center frequency (1200kHz). Instead of a large amount of spectral energy present at multiples of the switching frequency, the energy is now spread over a bandwidth that increases with frequency. Above a few megahertz, the wideband spectrum looks like white noise for EMI purposes (Figure 3).

2.2W, Low-EMI, Stereo, Class D Power Amplifiers with DirectDrive Headphone Amplifiers

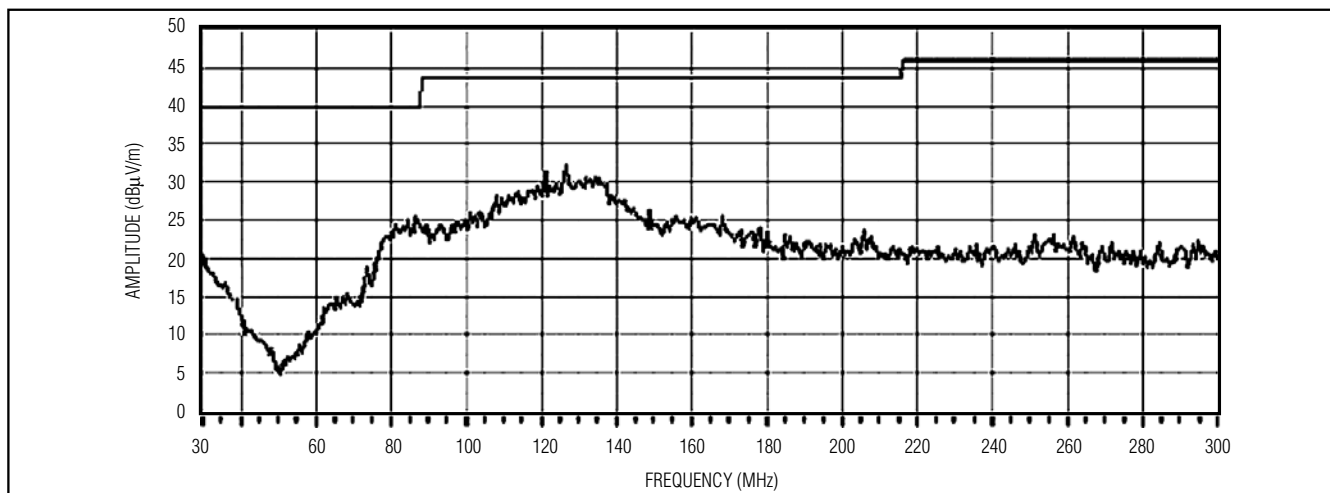

Figure 3. MAX9752/MAX9753/MAX9754 Radiated Emissions with 76mm of Speaker Cable

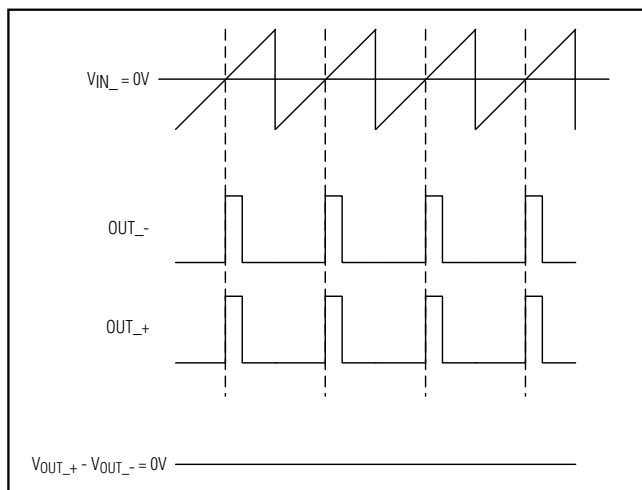

Figure 4. Second-Generation Class D Output Waveform with No Signal

Filterless Modulation/Common-Mode Idle

The MAX9752/MAX9753/MAX9754 use Maxim's unique modulation scheme that eliminates the LC filter required by traditional Class D amplifiers, improving efficiency, reducing component count, and conserving board space and system cost (Figure 4). With no input signal, the outputs are two low-duty-cycle pulses that are in-phase. This lowers the high-frequency energy and spectral content. In comparison, conventional Class D amplifiers output a 50% duty cycle when no input signal is present. For most applications with short speaker cables, no filtering is required.

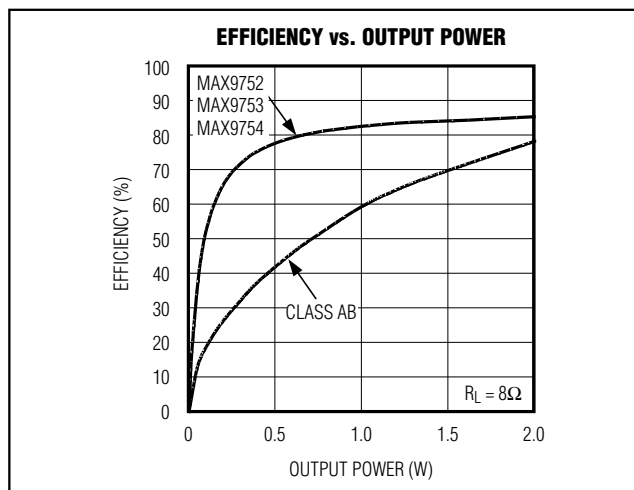

Figure 5. MAX9752/MAX9753/MAX9754 Class D Efficiency vs. MAX9750/MAX9751/MAX9755 Class AB Efficiency

Efficiency

Efficiency of a Class D amplifier is attributed to the region of operation of the output stage transistors. In a Class D amplifier, the output transistors act as switches and consume negligible power. Any power loss associated with the Class D output stage is mostly due to the I²R loss of the MOSFET on-resistance, and quiescent current overhead.

The theoretical best efficiency of a linear amplifier is 78%, however, that efficiency is only exhibited at peak output powers. Under normal operating levels (typical music reproduction levels), efficiency falls below 30%, whereas the MAX9752/MAX9753/MAX9754 still exhibit > 80% efficiencies under the same conditions (Figure 5).

2.2W, Low-EMI, Stereo, Class D Power Amplifiers with DirectDrive Headphone Amplifiers

Headphone Amplifier DirectDrive

Conventional single-supply headphone amplifiers have their outputs biased about a nominal DC voltage (typically half the supply) for maximum dynamic range. Large coupling capacitors are needed to block the DC bias from the headphones.

Maxim's DirectDrive architecture uses a charge pump to create an internal negative supply voltage. This allows the MAX9752/MAX9753/MAX9754 headphone amplifier output to be biased about GND, almost doubling the dynamic range, while operating from a single supply. With no DC component, there is no need for the large DC-blocking capacitors. Instead of two large capacitors (220 μ F, typ), the charge pump requires only two small ceramic capacitors (1 μ F typ), conserving board space, reducing cost, and improving the frequency response of the headphone amplifier. See the Output Power vs. Charge-Pump Capacitance and Load Resistance graph in the *Typical Operating Characteristics* for details of the possible capacitor values.

Previous attempts to eliminate the output-coupling capacitors involved biasing the headphone return (sleeve) to the DC bias voltage of the headphone amplifiers. This method raised some issues:

- 1) The sleeve is typically grounded to the chassis. Using this biasing approach, the sleeve must be isolated from system ground, complicating product design.
- 2) During an ESD strike, the amplifier's ESD structures are the only path to system ground. The amplifier must be able to withstand the full ESD strike.

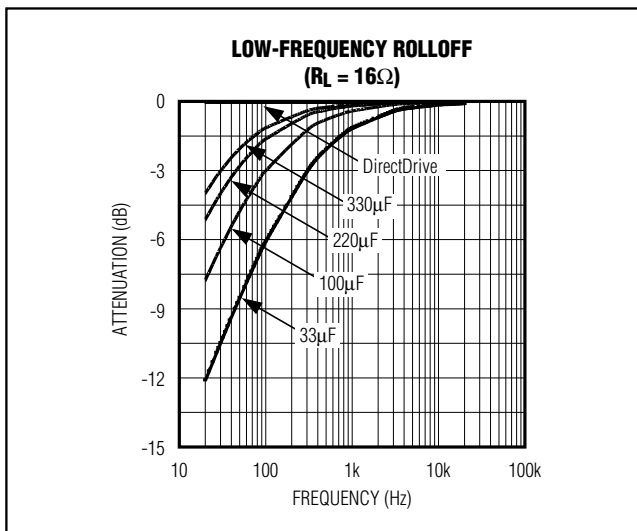

Figure 6. Low-Frequency Attenuation of Common DC-Blocking Capacitor Values

- 3) When using the headphone jack as a line out to other equipment, the bias voltage on the sleeve may conflict with the ground potential from other equipment, resulting in large ground-loop current and possible damage to the amplifiers.

Low-Frequency Response

In addition to the cost and size disadvantages, the DC-blocking capacitors limit the low-frequency response of the amplifier and distort the audio signal:

- 1) The impedance of the headphone load and the DC-blocking capacitor form a highpass filter with the -3dB point determined by:

$$f_{-3dB} = \frac{1}{2\pi R_L C_{OUT}}$$

where R_L is the impedance of the headphone and C_{OUT} is the value of the DC-blocking capacitor.

The highpass filter is required by conventional single-ended, single-supply headphone amplifiers to block the midrail DC component of the audio signal from the headphones. Depending on the -3dB point, the filter can attenuate low-frequency signals within the audio band. Larger values of C_{OUT} reduce the attenuation, but are physically larger, more expensive capacitors. Figure 6 shows the relationship between the size of C_{OUT} and the resulting low-frequency attenuation. Note the -3dB point for a 16 Ω headphone with a 100 μ F blocking capacitor is 100Hz, well within the audio band.

- 2) The voltage coefficient of the capacitor, the change in capacitance due to a change in the voltage across the capacitor, distorts the audio signal. At frequencies around the -3dB point, the reactance of the capacitor dominates, and the voltage coefficient appears as frequency-dependent distortion. Figure 7 shows the THD+N introduced by two different capacitor dielectrics. Note that around the -3dB point, THD+N increases dramatically.

The combination of low-frequency attenuation and frequency-dependent distortion compromises audio reproduction. DirectDrive improves low-frequency reproduction in portable audio equipment that emphasizes low-frequency effects such as multimedia laptops, MP3, CD, and DVD players.

2.2W, Low-EMI, Stereo, Class D Power Amplifiers with DirectDrive Headphone Amplifiers

MAX9752/MAX9753/MAX9754

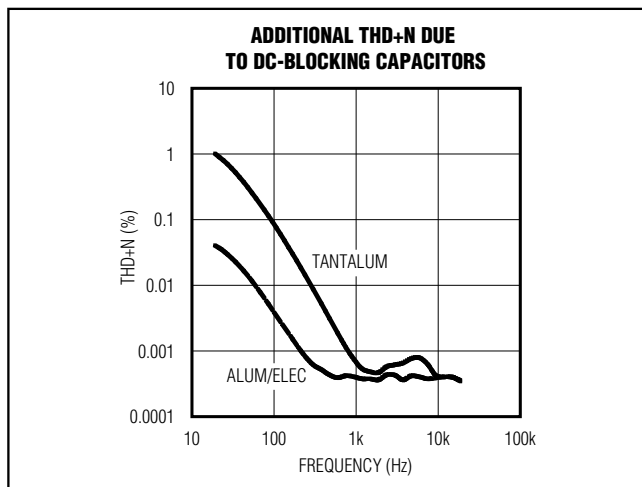

Figure 7. Distortion Contributed by DC-Blocking Capacitors

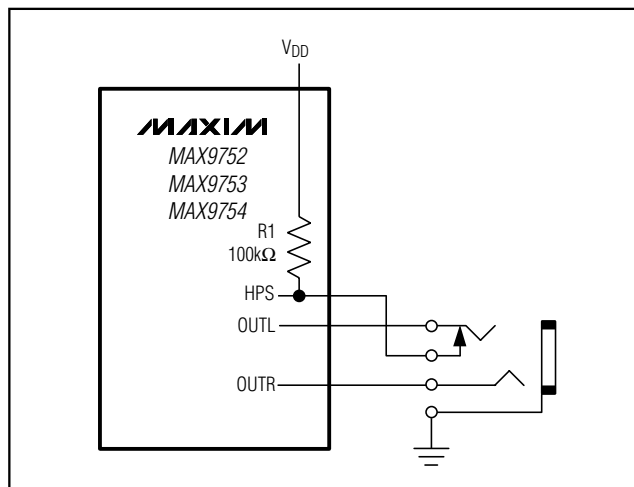

Figure 8. HPS Configuration

Table 1. MAX9752 Gain Settings

GAIN2	GAIN1	SPEAKER MODE GAIN (dB)			HEADPHONE MODE GAIN (dB)
		MAX9752A	MAX9752B	MAX9752C	
0	0	9.0	15.0	6.0	0
0	1	10.5	16.5	7.5	0
1	0	12.0	18.0	9.0	3
1	1	13.5	19.5	10.5	3

Charge Pump

The MAX9752/MAX9753/MAX9754 feature a low-noise charge pump. The 600kHz switching frequency is well beyond the audio range, and does not interfere with the audio signals. The switch drivers feature a controlled switching speed that minimizes noise generated by turn-on and turn-off transients. Limiting the switching speed of the charge pump minimizes the di/dt noise caused by the parasitic bond wire and trace inductance. Although not typically required, additional high-frequency ripple attenuation can be achieved by increasing the size of C2 (see the *Functional Diagrams*).

Headphone Sense Input (HPS)

The headphone sense input (HPS) monitors the headphone jack, and automatically configures the device based upon the voltage applied at HPS. A voltage of less than 0.8V sets the device to speaker mode. A voltage of greater than 2V disables the speaker amplifiers and enables the headphone amplifiers.

For automatic headphone detection, connect HPS to the control pin of a 3-wire headphone jack as shown in Figure 8. With no headphone present, the output imped-

ance of the headphone amplifier pulls HPS low. When a headphone plug is inserted into the jack, the control pin is disconnected from the tip contact and HPS is pulled to V_{DD} through the internal 100kΩ pullup resistor.

Bias

The MAX9752/MAX9753/MAX9754 feature an internally generated, power-supply-independent, common-mode bias voltage referenced to GND. BIAS provides both click-and-pop suppression and sets the DC bias level for the amplifiers. Choose the value of the bypass capacitor as described in the *BIAS Capacitor* section. No external load should be applied to BIAS.

Gain Selection

MAX9752

The MAX9752 features externally controlled gain with four pin-selectable gain ranges. GAIN1 and GAIN2 set the maximum gain of the MAX9752 speaker and headphone amplifiers (Table 1). The voltage at VOL varies the gain of the speaker and headphone amplifiers, providing a user-adjusted volume control, see the *Analog Volume Control (VOL, MAX9752)* section.

2.2W, Low-EMI, Stereo, Class D Power Amplifiers with DirectDrive Headphone Amplifiers

Table 2. MAX9752 Speaker Amplifier Gain Settings for Maximum Output Power

GAIN (dB)	INPUT (V _{RMS})	R _L (Ω)	P _{OUT} (W)
MAX9752A			
9.0	1.004	4	2.0
10.5	0.844	4	2.0
12.0	0.710	4	2.0
13.5	0.598	4	2.0
9.0	1.099	8	1.2
10.5	0.925	8	1.2
12.0	0.778	8	1.2
13.5	0.655	8	1.2
MAX9752B			
15.0	0.503	4	2.0
16.5	0.423	4	2.0
18.0	0.356	4	2.0
19.5	0.300	4	2.0
15.0	0.551	8	1.2
16.5	0.464	8	1.2
18.0	0.390	8	1.2
19.5	0.328	8	1.2
MAX9752C			
6.0	1.418	4	2.0
7.5	1.193	4	2.0
9.0	1.004	4	2.0
10.5	0.844	4	2.0
6.0	1.553	8	1.2
7.5	1.307	8	1.2
9.0	1.099	8	1.2
10.5	0.925	8	1.2

Table 2 shows the amplifier gain settings needed to attain maximum speaker output power from a given input voltage and load.

MAX9753/MAX9754

The gain of the MAX9753/MAX9754 is set by GAIN. Drive GAIN high to set the gain of the speaker amplifiers to 9dB, and the gain of the headphone amplifiers to 0dB. Drive GAIN low to set the gain of the speaker amplifiers to 10.5dB, and the gain of the headphone amplifiers to 3dB (Table 3).

Table 3. MAX9753/MAX9754 Maximum Gain Settings

GAIN	SPEAKER MODE GAIN (dB)	HEADPHONE MODE GAIN (dB)
0	10.5	3
1	9.0	0

Table 4. MAX9753/MAX9754 Input Voltage and Gain Settings for Maximum Output Power

GAIN (dB)	INPUT (V _{RMS})	R _L (Ω)	P _{OUT} (W)
10.5	0.844	4	2.0
9.0	1.004	4	2.0
10.5	0.925	8	1.2
9.0	1.099	8	1.2

Table 4 shows the amplifier input voltage needed to attain maximum speaker output power from a given gain setting and load.

Analog Volume Control (VOL, MAX9752)

The MAX9752 features an analog volume control that varies the speaker and headphone amplifier's gain in 31 discrete steps based upon the DC voltage applied to VOL. The input range of VOL is from 0 (full volume) to 0.858 x HPV_{DD} (full mute). Example step sizes are shown in Table 5. Control VOL with either a DAC or potentiometer as shown in Figure 9. Because the VOL input is high impedance (typically 100MΩ), it can also be driven with an RC-filtered PWM signal. Connect the reference of the DAC or potentiometer to HPV_{DD}. Since the volume control is ratiometric to HPV_{DD}, any changes in HPV_{DD} are negated. The gain step sizes are not constant, the step sizes at the upper extreme are 0.5dB/step, 2.0dB/step in the midrange, and 4.0dB/step at the lower extreme. Figure 10 shows the transfer function of the volume control for HPV_{DD} = 3.3V.

2.2W, Low-EMI, Stereo, Class D Power Amplifiers with DirectDrive Headphone Amplifiers

Table 5a. MAX9752A Volume Levels

V _{VOL} (V)		FRACTION OF HPV _{DD}	SPEAKER MODE GAIN (dB)				HEADPHONE MODE GAIN (dB)	
V _{MIN} *	V _{MAX} *		GAIN1 = 0, GAIN2 = 0	GAIN1 = 1, GAIN2 = 0	GAIN1 = 0, GAIN2 = 1	GAIN1 = 1 GAIN2 = 1	GAIN1 = X, GAIN2 = 0	GAIN1 = X, GAIN2 = 1
0	0.4900	0.074	9	10.5	12	13.5	0	3
0.4900	0.5673	0.160	8	10	11.5	13	-1	2.5
0.5673	0.6447	0.183	7	9	11	12.5	-2	2
0.6447	0.7220	0.207	6	8	10.5	12	-3	1.5
0.7220	0.7994	0.230	4	7	10	11.5	-5	1
0.7994	0.8767	0.253	2	6	9	11	-7	0
0.8767	0.9541	0.277	0	4	8	10.5	-9	-1
0.9541	1.0314	0.300	-2	2	7	10	-11	-2
1.0314	1.1088	0.324	-4	0	6	9	-13	-3
1.1088	1.1861	0.347	-6	-2	4	8	-15	-5
1.1861	1.2635	0.371	-8	-4	2	7	-17	-7
1.2635	1.3408	0.394	-10	-6	0	6	-19	-9
1.3408	1.4182	0.418	-12	-8	-2	4	-21	-11
1.4182	1.4955	0.441	-14	-10	-4	2	-23	-13
1.4955	1.5728	0.464	-16	-12	-6	0	-25	-15
1.5728	1.6502	0.488	-18	-14	-8	-2	-27	-17
1.6502	1.7275	0.511	-20	-16	-10	-4	-29	-19
1.7275	1.8049	0.535	-22	-18	-12	-6	-31	-21
1.8049	1.8822	0.558	-24	-20	-14	-8	-33	-23
1.8822	1.9596	0.582	-26	-22	-16	-10	-35	-25
1.9596	2.0369	0.605	-28	-24	-18	-12	-37	-27
2.0369	2.1143	0.628	-30	-26	-20	-14	-39	-29
2.1143	2.1916	0.652	-32	-28	-22	-16	-41	-31
2.1916	2.2690	0.675	-34	-30	-24	-18	-43	-33
2.2690	2.3463	0.699	-38	-32	-26	-20	-47	-35
2.3463	2.4237	0.722	-42	-34	-28	-22	-51	-37
2.4237	2.5010	0.746	-46	-38	-30	-24	-55	-39
2.5010	2.5783	0.769	-50	-42	-32	-26	-59	-41
2.5783	2.6557	0.793	-54	-46	-34	-28	-63	-43
2.6557	2.7330	0.816	-58	-50	-38	-30	-67	-47
2.7330	2.8104	0.839	-62	-54	-42	-32	-71	-51
2.8104	3.3000	0.858	MUTE	MUTE	MUTE	MUTE	MUTE	MUTE

*Based on HPV_{DD} = 3.3V.

X = Don't care.

MAX9752/MAX9753/MAX9754

2.2W, Low-EMI, Stereo, Class D Power Amplifiers with DirectDrive Headphone Amplifiers

Table 5b. MAX9752B Volume Levels

V _{VOL} (V)		FRACTION OF HPV _{DD}	SPEAKER MODE GAIN (dB)				HEADPHONE MODE GAIN (dB)	
V _{MIN} *	V _{MAX} *		GAIN1 = 0, GAIN2 = 0	GAIN1 = 1, GAIN2 = 0	GAIN1 = 0, GAIN2 = 1	GAIN1 = 1, GAIN2 = 1	GAIN1 = X, GAIN2 = 0	GAIN1 = X, GAIN2 = 1
0	0.4900	0.074	15	16.5	18	19.5	0	3
0.4900	0.5673	0.160	14	16	17.5	19	-1	2.5
0.5673	0.6447	0.183	13	15	17	18.5	-2	2
0.6447	0.7220	0.207	12	14	16.5	18	-3	1.5
0.7220	0.7994	0.230	10	13	16	17.5	-5	1
0.7994	0.8767	0.253	8	12	15	17	-7	0
0.8767	0.9541	0.277	6	10	14	16.5	-9	-1
0.9541	1.0314	0.300	4	8	13	16	-11	-2
1.0314	1.1088	0.324	2	6	12	15	-13	-3
1.1088	1.1861	0.347	0	4	10	14	-15	-5
1.1861	1.2635	0.371	-2	2	8	13	-17	-7
1.2635	1.3408	0.394	-4	0	6	12	-19	-9
1.3408	1.4182	0.418	-6	-2	4	10	-21	-11
1.4182	1.4955	0.441	-8	-4	2	8	-23	-13
1.4955	1.5728	0.464	-10	-6	0	6	-25	-15
1.5728	1.6502	0.488	-12	-8	-2	4	-27	-17
1.6502	1.7275	0.511	-14	-10	-4	2	-29	-19
1.7275	1.8049	0.535	-16	-12	-6	0	-31	-21
1.8049	1.8822	0.558	-18	-14	-8	-2	-33	-23
1.8822	1.9596	0.582	-20	-16	-10	-4	-35	-25
1.9596	2.0369	0.605	-22	-18	-12	-6	-37	-27
2.0369	2.1143	0.628	-24	-20	-14	-8	-39	-29
2.1143	2.1916	0.652	-26	-22	-16	-10	-41	-31
2.1916	2.2690	0.675	-28	-24	-18	-12	-43	-33
2.2690	2.3463	0.699	-32	-26	-20	-14	-47	-35
2.3463	2.4237	0.722	-36	-28	-22	-16	-51	-37
2.4237	2.5010	0.746	-40	-32	-24	-18	-55	-39
2.5010	2.5783	0.769	-44	-36	-26	-20	-59	-41
2.5783	2.6557	0.793	-48	-40	-28	-22	-63	-43
2.6557	2.7330	0.816	-52	-44	-32	-24	-67	-47
2.7330	2.8104	0.839	-56	-48	-36	-26	-71	-51
2.8104	3.3000	0.858	MUTE	MUTE	MUTE	MUTE	MUTE	MUTE

*Based on HPV_{DD} = 3.3V.

X = Don't care.

2.2W, Low-EMI, Stereo, Class D Power Amplifiers with DirectDrive Headphone Amplifiers

MAX9752/MAX9753/MAX9754

Table 5c. MAX9752C Volume Levels

V _{VOL} (V)		FRACTION OF HPV _{DD}	SPEAKER MODE GAIN (dB)				HEADPHONE MODE GAIN (dB)	
V _{MIN} *	V _{MAX} *		GAIN1 = 0, GAIN2 = 0	GAIN1 = 1, GAIN2 = 0	GAIN1 = 0, GAIN2 = 1	GAIN1 = 1 GAIN2 = 1	GAIN1 = X, GAIN2 = 0	GAIN1 = X, GAIN2 = 1
0	0.4900	0.074	6	7.5	9	10.5	0	3
0.4900	0.5673	0.160	5	7	8.5	10	-1	2.5
0.5673	0.6447	0.183	4	6	8	9.5	-2	2
0.6447	0.7220	0.207	3	5	7.5	9	-3	1.5
0.7220	0.7994	0.230	1	4	7	8.5	-5	1
0.7994	0.8767	0.253	-1	3	6	8	-7	0
0.8767	0.9541	0.277	-3	1	5	7.5	-9	-1
0.9541	1.0314	0.300	-5	-1	4	7	-11	-2
1.0314	1.1088	0.324	-7	-3	3	6	-13	-3
1.1088	1.1861	0.347	-9	-5	1	5	-15	-5
1.1861	1.2635	0.371	-11	-7	-1	4	-17	-7
1.2635	1.3408	0.394	-13	-9	-3	3	-19	-9
1.3408	1.4182	0.418	-15	-11	-5	1	-21	-11
1.4182	1.4955	0.441	-17	-13	-7	-1	-23	-13
1.4955	1.5728	0.464	-19	-15	-9	-3	-25	-15
1.5728	1.6502	0.488	-21	-17	-11	-5	-27	-17
1.6502	1.7275	0.511	-23	-19	-13	-7	-29	-19
1.7275	1.8049	0.535	-25	-21	-15	-9	-31	-21
1.8049	1.8822	0.558	-27	-23	-17	-11	-33	-23
1.8822	1.9596	0.582	-29	-25	-9	-13	-35	-25
1.9596	2.0369	0.605	-31	-27	-21	-15	-37	-27
2.0369	2.1143	0.628	-33	-29	-23	-17	-39	-29
2.1143	2.1916	0.652	-35	-31	-2	-19	-41	-31
2.1916	2.2690	0.675	-37	-3	-27	-21	-43	-33
2.2690	2.3463	0.699	-41	-35	-29	-23	-47	-35
2.3463	2.4237	0.722	-45	-37	-31	-25	-51	-37
2.4237	2.5010	0.746	-48	-41	-33	-27	-55	-39
2.5010	2.5783	0.769	-53	-45	-35	-29	-59	-41
2.5783	2.6557	0.793	-57	-49	-37	-31	-63	-43
2.6557	2.7330	0.816	-61	-53	-41	-33	-67	-47
2.7330	2.8104	0.839	-65	-57	-45	-35	-71	-51
2.8104	3.3000	0.858	MUTE	MUTE	MUTE	MUTE	MUTE	MUTE

*Based on HPV_{DD} = 3.3V.
X = Don't care.

2.2W, Low-EMI, Stereo, Class D Power Amplifiers with DirectDrive Headphone Amplifiers

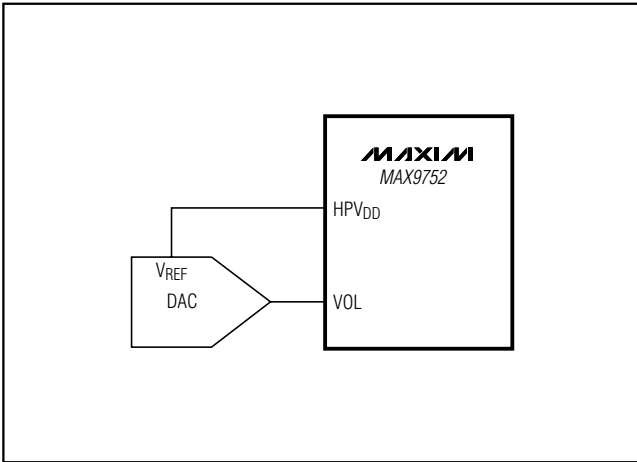

Figure 9. MAX9752 Volume-Control Circuit

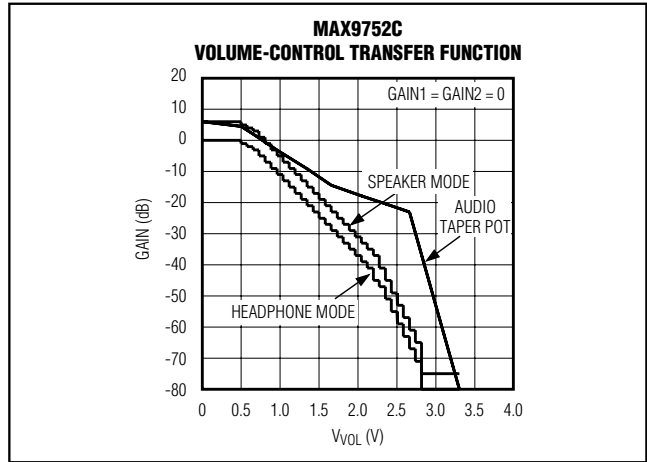

Figure 10c. MAX9752C Volume-Control Transfer Functions

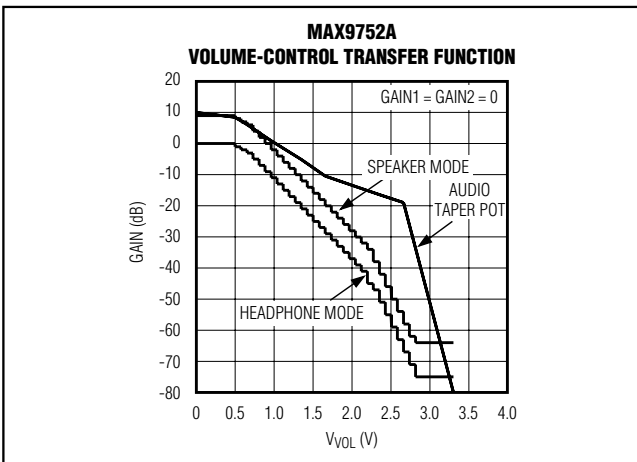

Figure 10a. MAX9752A Volume-Control Transfer Functions

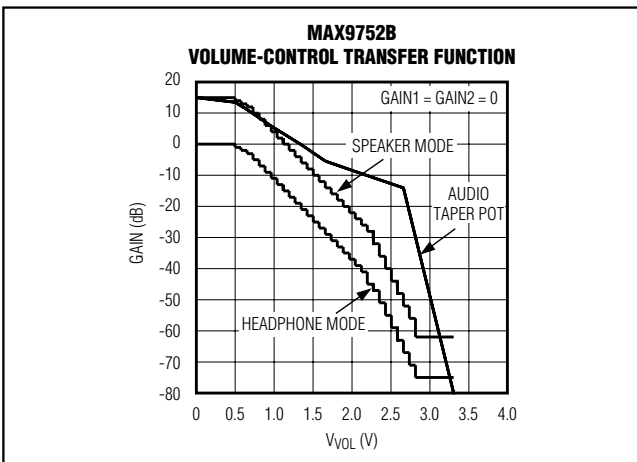

Figure 10b. MAX9752B Volume-Control Transfer Functions

Beep Input (MAX9752)

The MAX9752 features an audible alert beep input (BEEP). BEEP serves as the alert signal detector and the alert input to the amplifiers. AC-couple the alert output of a μC to BEEP. The MAX9752 monitors the signal at BEEP. When a signal exceeding $400\text{mV}_{\text{P-P}}$ with a frequency greater than 300Hz is detected at BEEP, the MAX9752 connects the signal to the amplifiers after eight periods of the input signal. In speaker mode, the alert signal appears at both speaker outputs, mixed with any audio that may be present. In headphone mode, the alert signal appears at the headphone outputs, mixed with any audio that may be present. A signal with less than eight input periods is ignored. Multiple BEEP signals can be summed as shown in Figure 11. Adding external resistors in series with BEEP increase the minimum voltage amplitude sensitivity.

Input Mux (MAX9753)

The MAX9753 features a 2:1 input multiplexer on each amplifier, allowing input selection between two stereo sources. The logic input $\text{IN1}/\overline{2}$ controls both multiplexers. A logic-high selects input IN_1 and a logic-low selects input IN_2 . The unselected inputs are high impedance.

Shutdown

The MAX9752/MAX9753/MAX9754 feature an $8\mu\text{A}$, low-power shutdown mode reducing quiescent current consumption and extending battery life. Driving $\overline{\text{SHDN}}$ low disables the drive amplifiers, bias circuitry, charge pump, and sets the headphone amplifier output impedance to $1\text{k}\Omega$, and drives $\overline{\text{BIAS}}$ to GND. Connect $\overline{\text{SHDN}}$ to V_{DD} for normal operation.

2.2W, Low-EMI, Stereo, Class D Power Amplifiers with DirectDrive Headphone Amplifiers

MAX9752/MAX9753/MAX9754

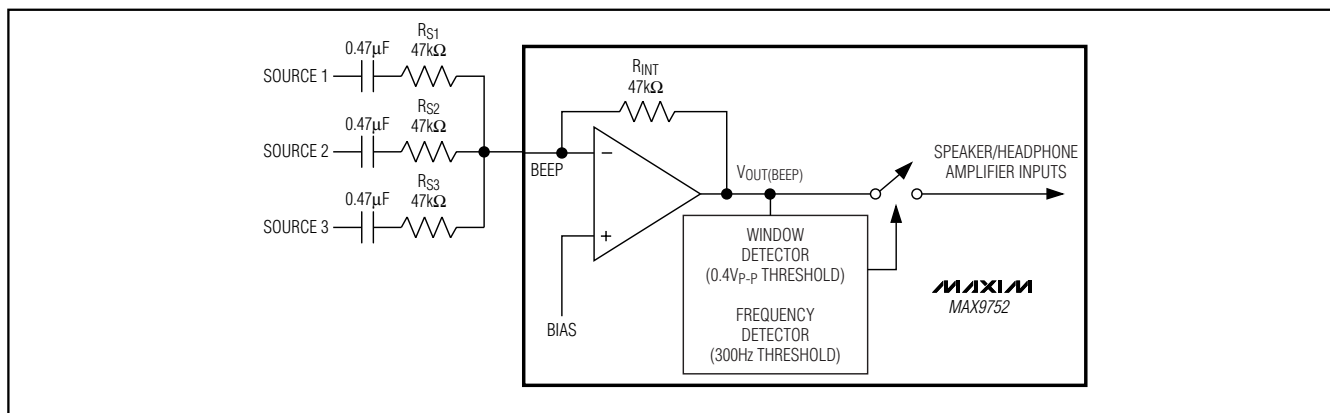

Figure 11. MAX9752 Beep Summing Circuit

Click-and-Pop Suppression

The MAX9752/MAX9753/MAX9754 feature Maxim's comprehensive, industry-leading click-and-pop suppression eliminating audible transients at startup. The Turn-On and Turn-Off Response waveforms in the *Typical Operating Characteristics* show that there are minimal spectral components in the audible range at the output upon startup and shutdown.

Applications Information

Compatibility with MAX9750/MAX9751/MAX9755

The MAX9752/MAX9753/MAX9754 provide a high-efficiency, Class D speaker driver with very low EMI (see the *Typical Operating Characteristics*). If a Class AB output is desired, the MAX9750/MAX9751/MAX9755 can be substituted. The MAX9750, MAX9751, and MAX9755 are pin-for-pin compatible with the MAX9752, MAX9753, and MAX9754, respectively.

Filterless Operation

The MAX9752/MAX9753/MAX9754 do not require an output filter in most applications. The devices rely on the inherent inductance of the speaker coil and the natural filtering of both the speaker and the human ear to recover the audio component of the square-wave output. Eliminating the output filter results in a smaller, less costly, more efficient solution.

Voice coil movement due to the square-wave frequency is very small because the switching frequency is well beyond the bandwidth of speakers. Although this movement is small, a speaker not designed to handle the additional power can be damaged. Use a speaker with a series inductance > 30µH for optimum results. Typical 8Ω speakers exhibit series inductances in the 30µH to 100µH range. Highest efficiency is achieved with speaker inductances > 60µH.

Power Dissipation and Heat Sinking

Because the MAX9752/MAX9753/MAX9754 have high-efficiency, Class D speaker drivers, the intrinsic package power dissipation capabilities are sufficient for cooling. No special heatsinking is needed in normal operating conditions.

Headphone Amplifier Output Power

The headphone amplifiers have been specified for the worst-case scenario—when both inputs are in-phase. Under this condition, the drivers simultaneously draw current from the charge pump, leading to a slight loss in headroom of V_{SS} . In typical stereo audio applications, the left and right signals have differences in both magnitude and phase, subsequently leading to an increase in the maximum attainable output power. Figure 12 shows the two cases for in- and out-of-phase. In reality, the available power lies between these extremes.

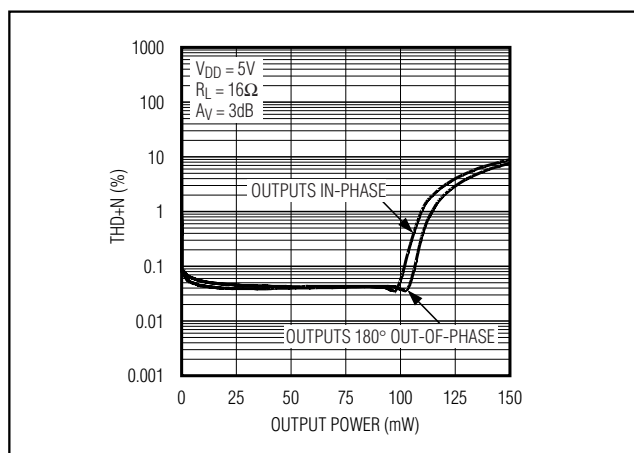

Figure 12. THD+N vs. P_{OUT} with Headphone Output Signals In- and Out-of-Phase

2.2W, Low-EMI, Stereo, Class D Power Amplifiers with DirectDrive Headphone Amplifiers

Power Supplies

The MAX9752/MAX9753/MAX9754 have different supplies for each portion of the device allowing for the optimum combination of headroom, power dissipation, and noise immunity. The speaker amplifiers are powered from PVDD. PVDD ranges from 4.5V to 5.5V. The headphone amplifiers are powered from HPVDD and VSS. HPVDD is the positive supply of the headphone amplifiers and ranges from 3V to 5.5V. VSS is the negative supply input for the headphone amplifiers. Connect VSS to CPVSS. The charge pump is powered by CPVDD, which ranges from 3V to 5.5V. CPVDD should be the same potential as HPVDD. The charge pump inverts the voltage at CPVDD, and the resulting voltage appears at CPVSS. The remainder of the device is powered by VDD.

Component Selection

Input Filtering

The input capacitor (C_{IN}), in conjunction with the amplifier input resistance (R_{IN}), forms a highpass filter that removes the DC bias from an incoming signal (see the *Functional Diagrams*). The AC-coupling capacitor allows the amplifier to bias the signal to an optimum DC level. Assuming zero source impedance, the -3dB point of the highpass filter is given by:

$$f_{-3dB} = \frac{1}{2\pi R_{IN} C_{IN}}$$

R_{IN} is the amplifier's internal input resistance value given in the *Electrical Characteristics* table. Choose C_{IN} so f_{-3dB} is well below the lowest frequency of interest. Setting f_{-3dB} too high affects the amplifier's low-frequency response. Use capacitors with low-voltage coefficient dielectrics, such as tantalum or aluminum electrolytic. Capacitors with high-voltage coefficients, such as ceramics, may result in increased distortion at low frequencies.

Optional Output Filtering

In most applications, the low-EMI, Class D outputs do not require output filters. The device passes FCC emissions standards with 76mm of unshielded speaker cables. Output filtering can be used if lower EMI is desired. Use a ferrite bead filter when radiated frequencies above 10MHz are of concern. Use an LC filter when radiated frequencies below 10MHz are of concern, or when long leads (> 76mm) connect the amplifier to the speaker.

BIAS Capacitor

BIAS is the output of the internally generated DC bias voltage. The BIAS bypass capacitor, C_{BIAS} , improves PSRR and THD+N by reducing power supply and other noise sources at the common-mode bias node, and also generates the clickless/popless, startup/shutdown, DC bias waveforms for the speaker amplifiers. Bypass BIAS with a 1 μ F capacitor to GND.

Charge-Pump Capacitor Selection

Use capacitors with less than 100m Ω of equivalent series resistance (ESR). Low-ESR ceramic capacitors minimize the output impedance of the charge pump. Capacitors with an X7R dielectric provide the best performance over the extended temperature range.

Flying Capacitor (C1)

The value of the flying capacitor (C_1) affects the load regulation and output resistance of the charge pump. Choosing C_1 too small degrades the ability to provide sufficient current drive, which leads to a loss of output voltage. Increasing the value of C_1 improves load regulation and reduces the charge-pump output resistance. See the Output Power vs. Charge-Pump Capacitance and Load Resistance graph in the *Typical Operating Characteristics*. Above 2.2 μ F, the on-resistance of the switches and the ESR of C_1 and C_2 dominate. The recommended range of capacitors is from 0.33 μ F to 3.3 μ F.

Output Capacitor (C2)

The output capacitor value and ESR directly affect the ripple at CPVSS. Increasing the value of C_2 reduces output ripple. Decreasing the ESR of C_2 reduces both ripple and output resistance. Lower capacitance values can be used in systems with low, maximum output power levels. See the Output Power vs. Charge-Pump Capacitance and Load Resistance graph in the *Typical Operating Characteristics*. C_2 must be greater than or equal to C_1 . The recommended range of capacitors is from 0.33 μ F to 3.3 μ F.

CPVDD Bypass Capacitor

The CPVDD bypass capacitor (C_3) lowers the output impedance of the power supply and reduces the impact of the charge-pump switching transients on the headphone driver outputs. Bypass CPVDD with C_3 , the same value as C_1 , and place it physically close to CPVDD and PGND.

Layout and Grounding

Proper layout and grounding are essential for optimum performance. Use large traces for the power-supply inputs and amplifier outputs to minimize losses due to parasitic trace resistance. Large traces also aid in moving heat away from the package. Proper grounding improves audio performance, minimizes crosstalk between channels, and prevents any switching noise from coupling into the audio signal. Connect CPGND, PGND, and GND together at a single point on the PC board. Route CPGND, PGND, and all traces that carry switching transients away from GND and the traces and components in the audio signal path.

2.2W, Low-EMI, Stereo, Class D Power Amplifiers with DirectDrive Headphone Amplifiers

Connect all components associated with the charge pump (C2 and C3) to CPGND. Connect V_{SS} and CPV_{SS} together at C2. Place the charge-pump capacitors (C1, C2, and C3) as close to the device as possible. Bypass HPV_{DD} with 1 μ F to GND. Bypass PV_{DD} with a 0.1 μ F capacitor and a 100 μ F capacitor to PGND. Place the bypass capacitors as close to the device as possible.

Use large, low-resistance output traces. Current drawn from the outputs increases as load impedance decreases. High-output-trace resistance decreases the power delivered to the load. For example, when compared to a 0 Ω trace, a 100m Ω trace reduces the power delivered to a 4 Ω load from 2.1W to 2.0W. Large output, supply, and GND traces allow more heat to move from the MAX9752/MAX9753/MAX9754 to the air, reducing the thermal impedance of the system.

The MAX9752/MAX9753/MAX9754 thin QFN packages feature exposed pads on their undersides. Connect the exposed pad to GND with a large copper pad and multiple vias to the ground plane.

Measuring Class D Outputs with an Analog Analyzer

Filterless Class D amplifiers use the loudspeaker's coil inductance to filter out switching energy. Additionally, the loudspeaker does not respond to the switching frequency of Class D amplifiers, nor could human ears hear these frequencies. However, audio analyzers and oscilloscopes can detect these signals. On an oscilloscope,

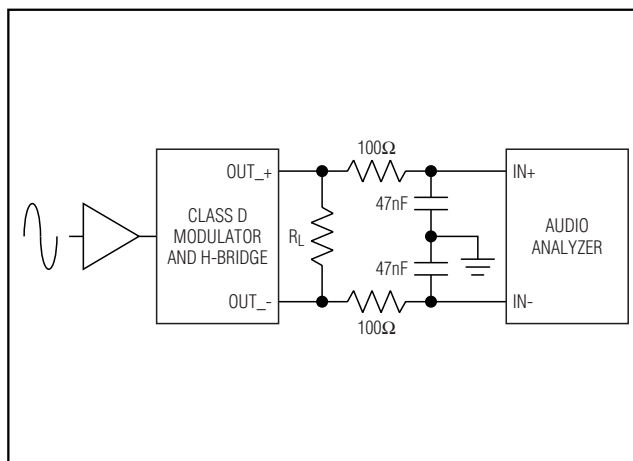
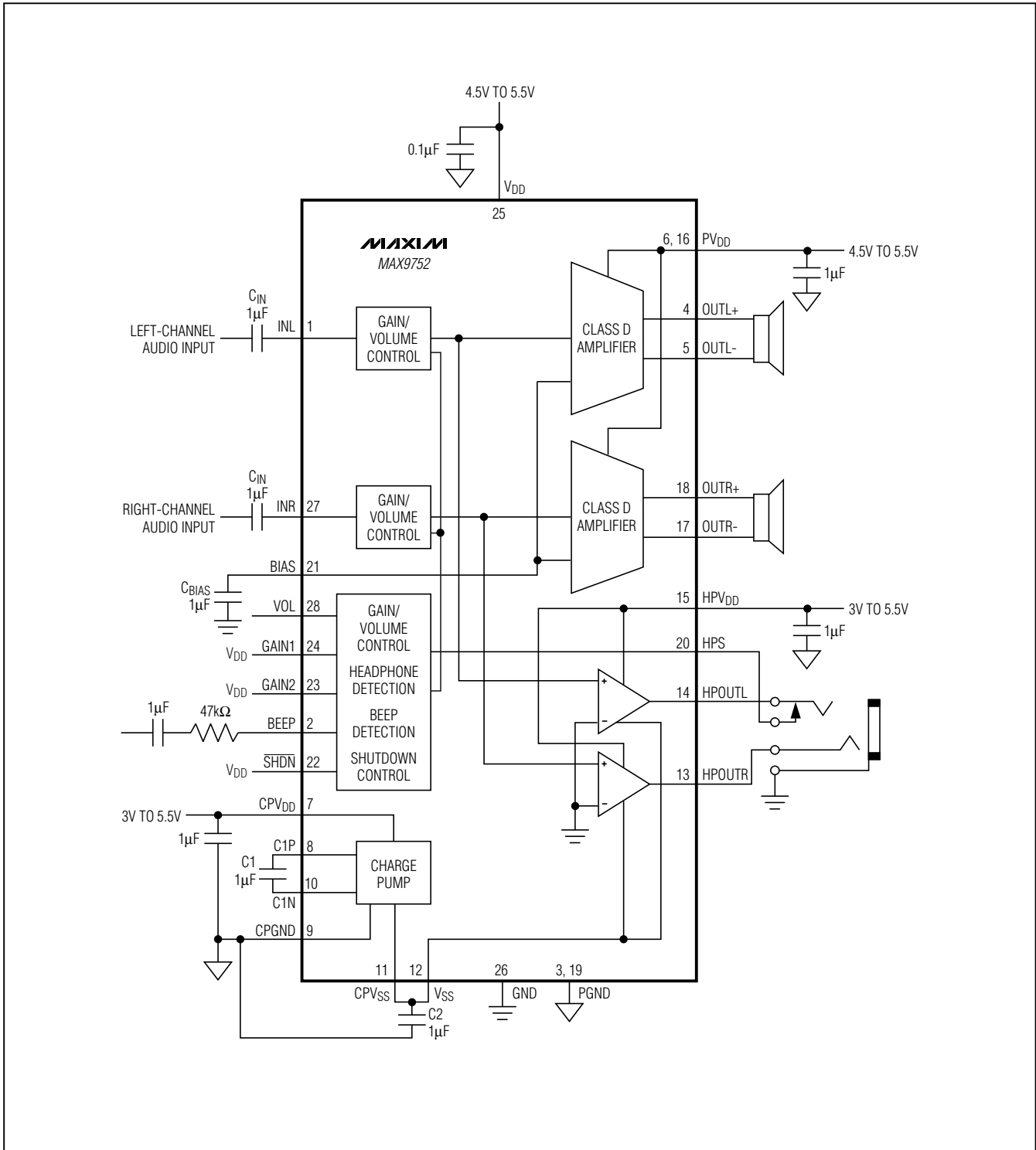

Figure 13. Connecting a Class D Output to an Analog Analyzer

the switching components obscure the audio signal. On an audio analyzer they overload the input signal, degrading the measurement from the true audio performance of the amplifier. A simple RC filter can be used (Figure 13) to aid in evaluation of Class D amplifiers in the lab. This circuit provides a single-pole response at 34kHz, with a minimal insertion loss. More complex designs such as L-C filters can provide more performance, but must be verified to ensure they do not add their own distortion signature to the amplifier's output.

2.2W, Low-EMI, Stereo, Class D Power Amplifiers with DirectDrive Headphone Amplifiers

MAX9752 Functional Diagram



2.2W, Low-EMI, Stereo, Class D Power Amplifiers with DirectDrive Headphone Amplifiers

MAX9753 Functional Diagram

MAX9752/MAX9753/MAX9754

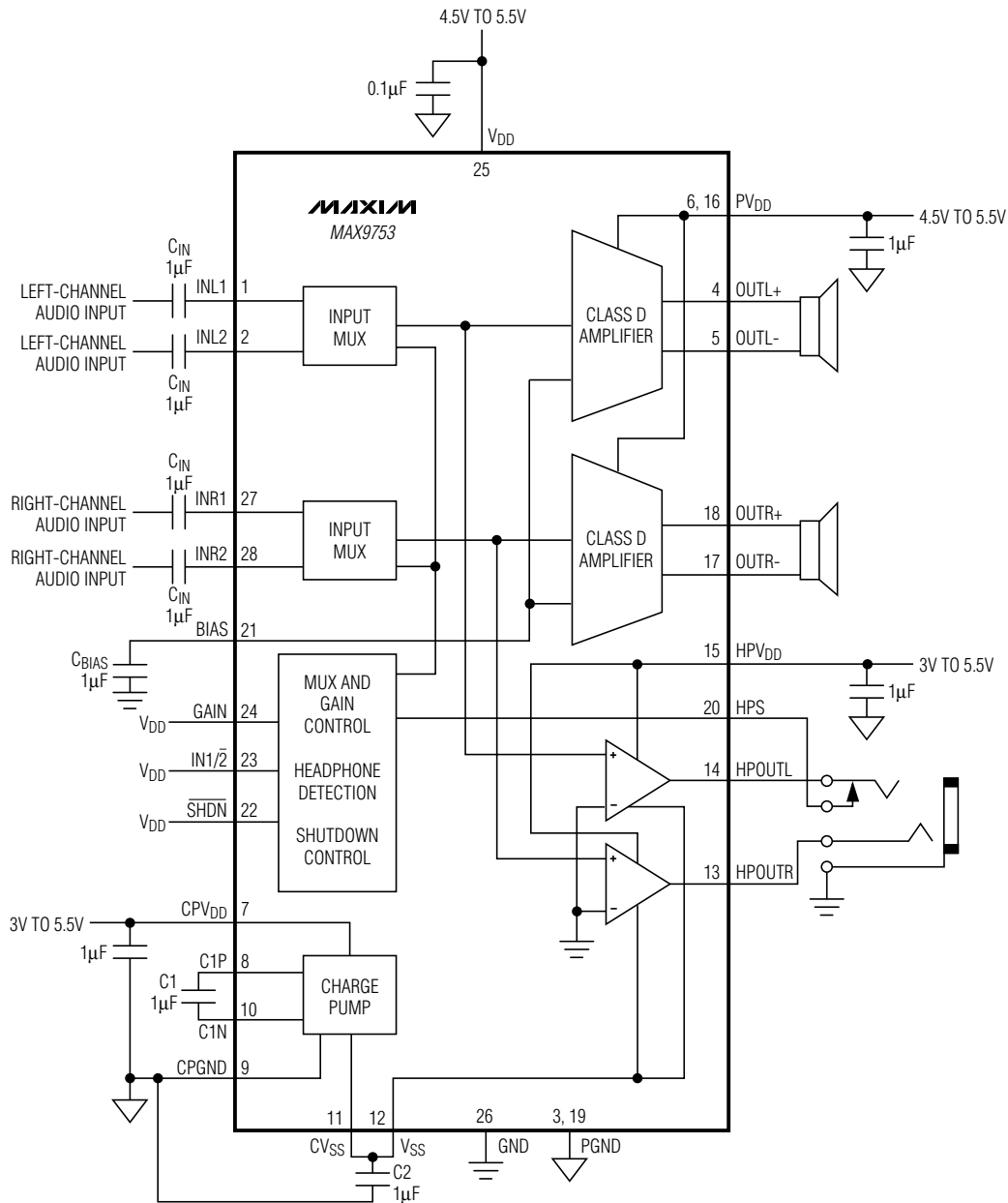

LOGIC PINS CONFIGURED FOR:
 GAIN = 1, 9dB SPEAKER GAIN/0dB HEADPHONE GAIN.
 IN1/2 = 1, SELECTED INPUT LINE 1.
 SHDN = 1, PART ACTIVE.

2.2W, Low-EMI, Stereo, Class D Power Amplifiers with DirectDrive Headphone Amplifiers

MAX9754 Functional Diagram

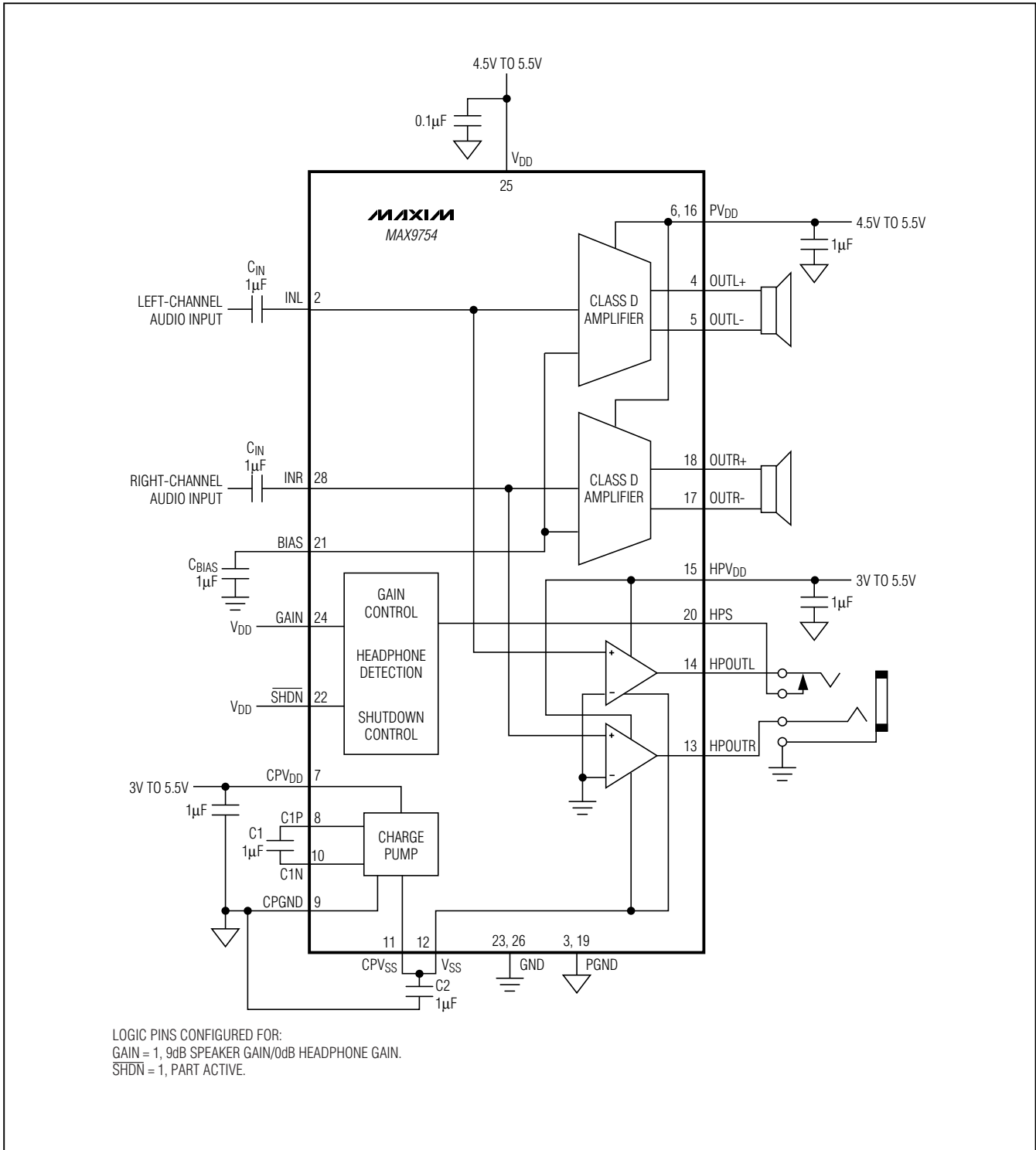

2.2W, Low-EMI, Stereo, Class D Power Amplifiers with DirectDrive Headphone Amplifiers

Pin Configurations

MAX9752/MAX9753/MAX9754

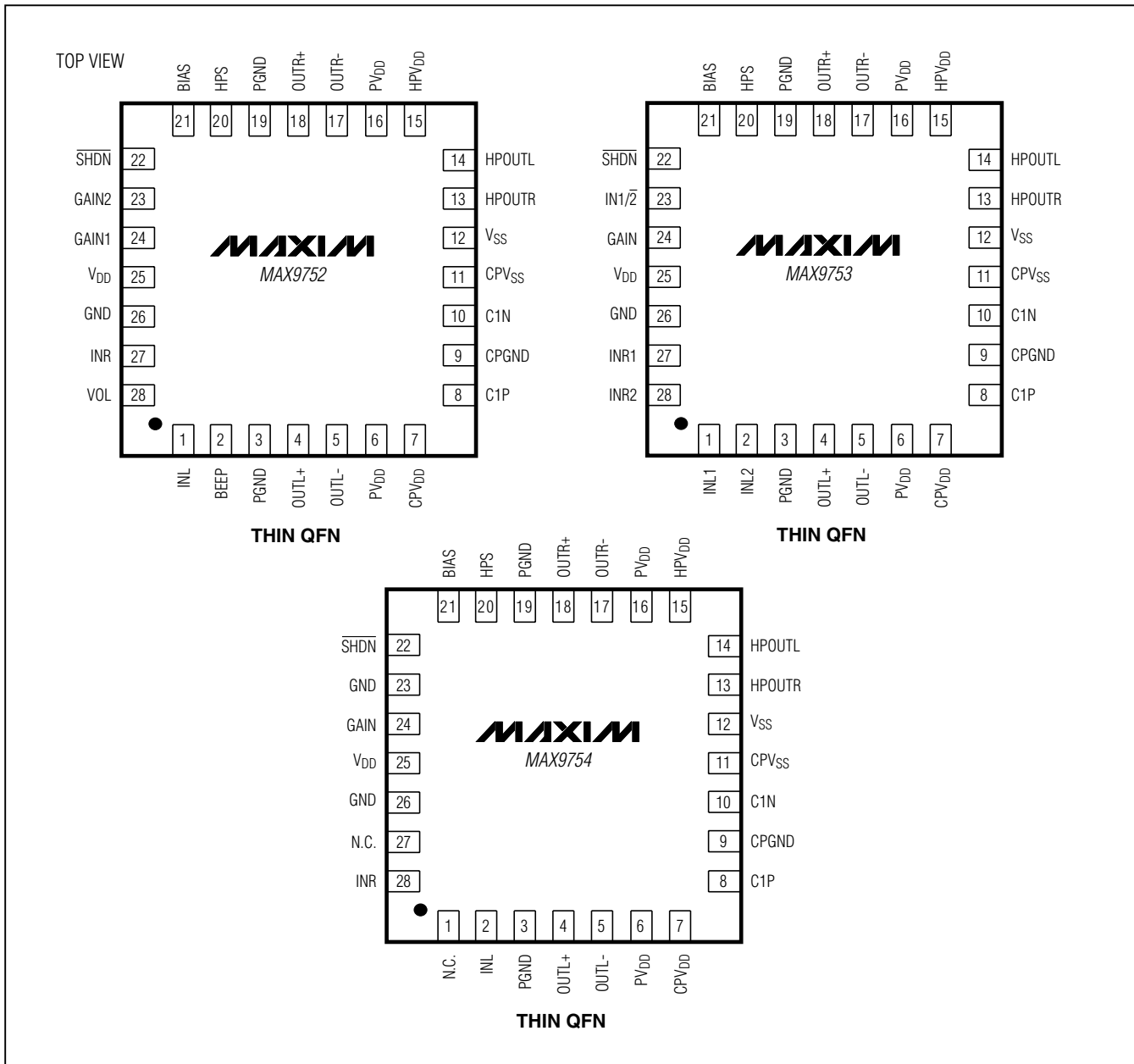

Chip Information

MAX9752 TRANSISTOR COUNT: 12,263

MAX9753/MAX9754 TRANSISTOR COUNT: 12,137

PROCESS: BiCMOS

2.2W, Low-EMI, Stereo, Class D Power Amplifiers with DirectDrive Headphone Amplifiers

Package Information

(The package drawing(s) in this data sheet may not reflect the most current specifications. For the latest package outline information, go to www.maxim-ic.com/packages.)

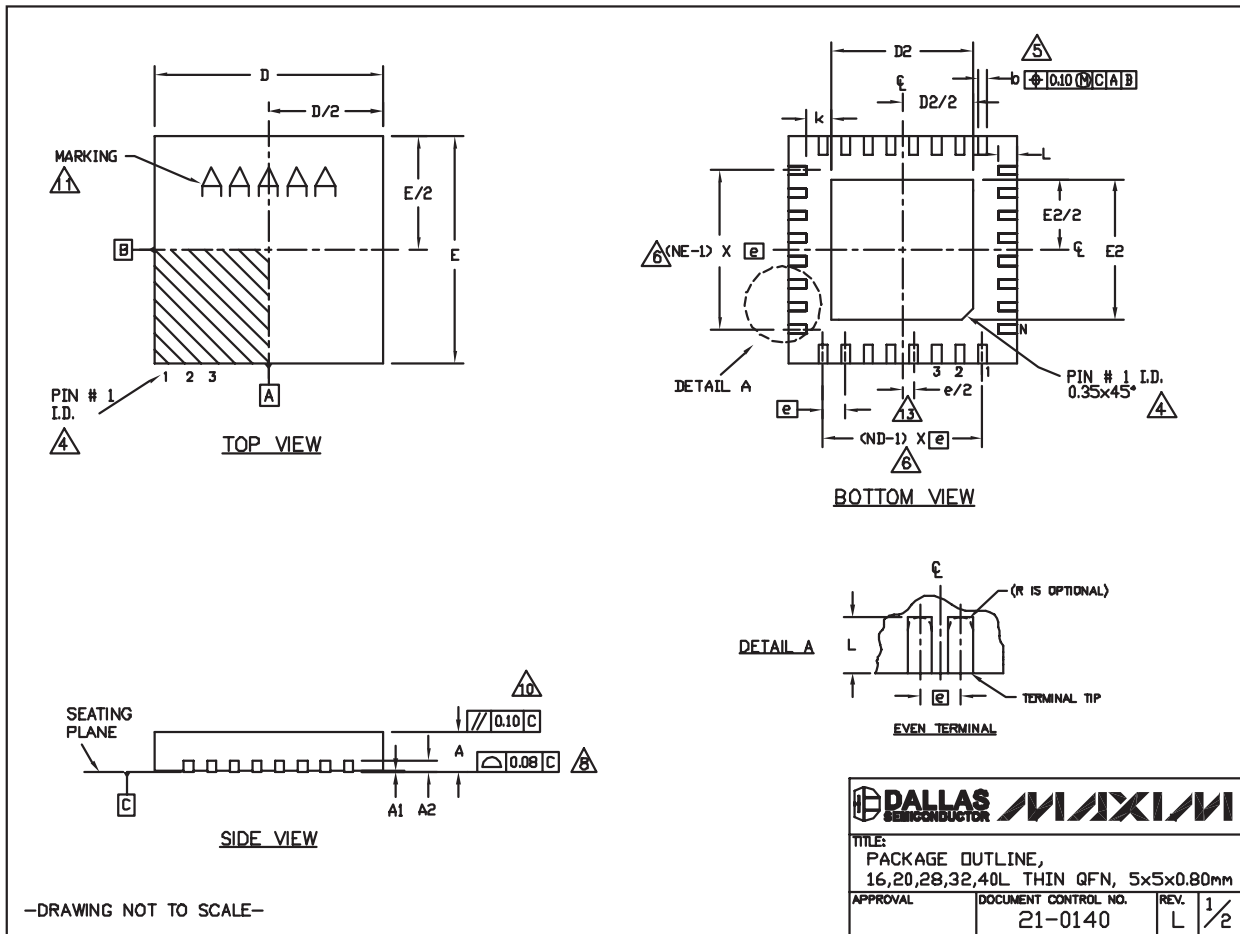

2.2W, Low-EMI, Stereo, Class D Power Amplifiers with DirectDrive Headphone Amplifiers

Package Information (continued)

(The package drawing(s) in this data sheet may not reflect the most current specifications. For the latest package outline information, go to www.maxim-ic.com/packages.)

MAX9752/MAX9753/MAX9754

COMMON DIMENSIONS															
PKG. SYMBOL	16L 5x5			20L 5x5			28L 5x5			32L 5x5			40L 5x5		
	MIN.	NOM.	MAX.	MIN.	NOM.	MAX.	MIN.	NOM.	MAX.	MIN.	NOM.	MAX.	MIN.	NOM.	MAX.
A	0.70	0.75	0.80	0.70	0.75	0.80	0.70	0.75	0.80	0.70	0.75	0.80	0.70	0.75	0.80
A1	0	0.02	0.05	0	0.02	0.05	0	0.02	0.05	0	0.02	0.05	0	0.02	0.05
A2	0.20 REF.			0.20 REF.			0.20 REF.			0.20 REF.			0.20 REF.		
b	0.25	0.30	0.35	0.25	0.30	0.35	0.20	0.25	0.30	0.20	0.25	0.30	0.15	0.20	0.25
D	4.90	5.00	5.10	4.90	5.00	5.10	4.90	5.00	5.10	4.90	5.00	5.10	4.90	5.00	5.10
E	4.90	5.00	5.10	4.90	5.00	5.10	4.90	5.00	5.10	4.90	5.00	5.10	4.90	5.00	5.10
e	0.80 BSC.			0.65 BSC.			0.50 BSC.			0.50 BSC.			0.40 BSC.		
k	0.25	-	-	0.25	-	-	0.25	-	-	0.25	-	-	0.25	-	-
L	0.30	0.40	0.50	0.45	0.55	0.65	0.45	0.55	0.65	0.30	0.40	0.50	0.30	0.40	0.50
N	16			20			28			32			40		
ND	4			5			7			8			10		
NE	4			5			7			8			10		
JEDEC	VHFB			VHHC			VHHD-1			VHHD-2			-----		

EXPOSED PAD VARIATIONS						
PKG. CODES	D2			E2		
	MIN.	NOM.	MAX.	MIN.	NOM.	MAX.
T1655-2	3.00	3.10	3.20	3.00	3.10	3.20
T1655-3	3.00	3.10	3.20	3.00	3.10	3.20
T1655N-1	3.00	3.10	3.20	3.00	3.10	3.20
T2055-3	3.00	3.10	3.20	3.00	3.10	3.20
T2055-4	3.00	3.10	3.20	3.00	3.10	3.20
T2055-5	3.15	3.25	3.35	3.15	3.25	3.35
T2055MN-5	3.15	3.25	3.35	3.15	3.25	3.35
T2855-3	3.15	3.25	3.35	3.15	3.25	3.35
T2855-4	2.60	2.70	2.80	2.60	2.70	2.80
T2855-5	2.60	2.70	2.80	2.60	2.70	2.80
T2855-6	3.15	3.25	3.35	3.15	3.25	3.35
T2855-7	2.60	2.70	2.80	2.60	2.70	2.80
T2855-8	3.15	3.25	3.35	3.15	3.25	3.35
T2855N-1	3.15	3.25	3.35	3.15	3.25	3.35
T3255-3	3.00	3.10	3.20	3.00	3.10	3.20
T3255-4	3.00	3.10	3.20	3.00	3.10	3.20
T3255H-4	3.00	3.10	3.20	3.00	3.10	3.20
T3255-5	3.00	3.10	3.20	3.00	3.10	3.20
T3255N-1	3.00	3.10	3.20	3.00	3.10	3.20
T4055-1	3.40	3.50	3.60	3.40	3.50	3.60
T4055-2	3.40	3.50	3.60	3.40	3.50	3.60
T4055MN-1	3.40	3.50	3.60	3.40	3.50	3.60

NOTES:

- DIMENSIONING & TOLERANCING CONFORM TO ASME Y14.5M-1994.
- ALL DIMENSIONS ARE IN MILLIMETERS. ANGLES ARE IN DEGREES.
- N IS THE TOTAL NUMBER OF TERMINALS.
- THE TERMINAL #1 IDENTIFIER AND TERMINAL NUMBERING CONVENTION SHALL CONFORM TO JEDEC 95-1 SPP-012. DETAILS OF TERMINAL #1 IDENTIFIER ARE OPTIONAL, BUT MUST BE LOCATED WITHIN THE ZONE INDICATED. THE TERMINAL #1 IDENTIFIER MAY BE EITHER A MOLD OR MARKED FEATURE.
- DIMENSION b APPLIES TO METALLIZED TERMINAL AND IS MEASURED BETWEEN 0.25 mm AND 0.30 mm FROM TERMINAL TIP.
- ND AND NE REFER TO THE NUMBER OF TERMINALS ON EACH D AND E SIDE RESPECTIVELY.
- DEPOPULATION IS POSSIBLE IN A SYMMETRICAL FASHION.
- COPLANARITY APPLIES TO THE EXPOSED HEAT SINK SLUG AS WELL AS THE TERMINALS.
- DRAWING CONFORMS TO JEDEC MO220, EXCEPT EXPOSED PAD DIMENSION FOR T2855-3, T2855-6, T4055-1 AND T4055-2.
- WARPAGE SHALL NOT EXCEED 0.10 mm.
- MARKING IS FOR PACKAGE ORIENTATION REFERENCE ONLY.
- NUMBER OF LEADS SHOWN ARE FOR REFERENCE ONLY.
- LEAD CENTERLINES TO BE AT TRUE POSITION AS DEFINED BY BASIC DIMENSION 'e', ±0.05.
- ALL DIMENSIONS APPLY TO BOTH LEADED AND PbFREE PARTS.

—DRAWING NOT TO SCALE—

		
TITLE: PACKAGE OUTLINE, 16,20,28,32,40L THIN QFN, 5x5x0.80mm		
APPROVAL	DOCUMENT CONTROL NO.	REV.
	21-0140	L 2/2

Maxim cannot assume responsibility for use of any circuitry other than circuitry entirely embodied in a Maxim product. No circuit patent licenses are implied. Maxim reserves the right to change the circuitry and specifications without notice at any time.

Maxim Integrated Products, 120 San Gabriel Drive, Sunnyvale, CA 94086 408-737-7600

29