

# PRODUCT SPECIFICATION

DATE : 05/21/2007

<b>cosmo</b> ELECTRONICS CORPORATION	Power Photo TRIAC :	62P46002	REV.
	<b>KTLP3507H</b>	SHEET 1 OF 6	2

## Photo Coupler for Power Photo TRIAC Output

### ● Features

1. Compact dual-in-line package.
2. 600V peak blocking voltage.
3. Isolation voltage between input and output 5000Vrms.

### ● Application :

1. TRIAC Driver.
2. Programmable Controllers.
3. AC-Output Module.
4. Solid State Relay.

# PRODUCT SPECIFICATION

DATE : 05/21/2007

<b>cosmo</b> ELECTRONICS CORPORATION	Power Photo TRIAC :	62P46002	REV.
	<b>KTLP3507H</b>	SHEET 2 OF 6	2

## ● Outside dimension : Unit ( mm )

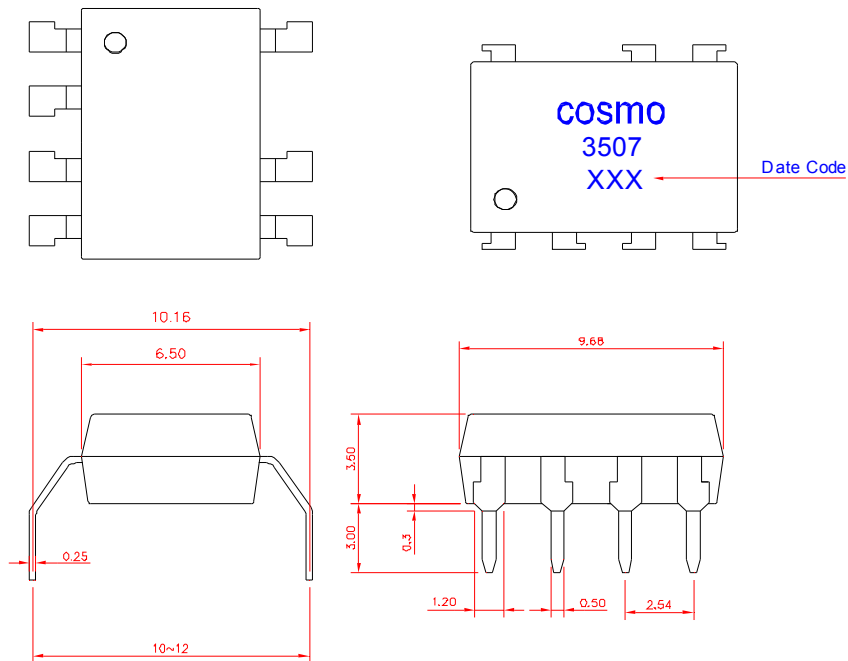

Tolerance :  $\pm 0.2\text{mm}$

## ● Schematic : Top View

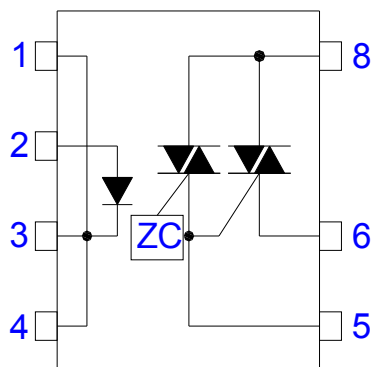

1. Cathode
2. Anode
3. Cathode
4. Cathode
5. Gate
6. T1
8. T2

# PRODUCT SPECIFICATION

DATE : 05/21/2007

<b>cosmo</b> ELECTRONICS CORPORATION	Power Photo TRIAC :	<b>62P46002</b>	REV. 2
	<b>KTLP3507H</b>	SHEET 3 OF 6	

## ● Absolute Maximum Ratings

Parameter		Symbol	Rating	Unit
Input	Forward current	$I_F$	50	mA
	Peak forward current	$I_{FP}$	1	A
	Reverse voltage	$V_R$	6	V
Output	Off-State Output Terminal voltage	$V_{DRM}$	600	V
	On-State R.M.S. Current	$I_{T(RMS)}$	0.5	A
	Peak Nonrepetitive Surge Current ( 60Hz, Peak )	$I_{TSM}$	10	A
Isolation voltage ( AC, 1 minute )		$V_{iso}$	5000	$V_{rms}$
Operating temperature		$T_{opr}$	-40 to +85	°C
Storage temperature		$T_{stg}$	-40 to +125	°C
Soldering temperature 10 second		$T_{sol}$	260	°C

## ● Electro-optical Characteristics

Parameter		Symbol	Conditions	MIN.	TYP.	MAX.	Unit
Input	Forward voltage	$V_F$	$I_F = 10mA$	-	1.2	1.4	V
	Reverse current	$I_R$	$V_R = 6V$	-	-	10	$\mu A$
Output	Peak Blocking Current	$I_{DRM}$	$V_{DRM} = \text{Rated}$	-	-	100	$\mu A$
	On-State Voltage	$V_{TM}$	$I_T = 0.75A$	-	-	3	V
	Holding Current	$I_H$	$V_D = 5V$	-	-	25	mA
	Critical rate of rise of Off-state voltage	dV/dt	$V_{DRM} = (1/\sqrt{2}) \cdot \text{Rated}$	-	1000	-	V/ $\mu s$
Transfer characteristics	Inhibit voltage ( MT1-MT2 Voltage above which device not trigger )	$V_{INH}$	$I_F = \text{Rated } I_{FT}$	-	-	50	V
	Leakage in Inhibited State	$I_{DRM2}$	$I_F = \text{Rated } I_{FT}, \text{ Rated } V_{DRM},$ Off State	-	200	-	$\mu A$
	Isolation resistance	$R_{iso}$	DC500V	$5 \times 10^{10}$	-	-	$\Omega$
	Minimum trigger current	$I_{FT}$	$V_D = 5V$	-	-	10	mA

# PRODUCT SPECIFICATION

DATE : 05/21/2007

<b>cosmo</b> ELECTRONICS CORPORATION	Power Photo TRIAC :	62P46002	REV.
	<b>KTLP3507H</b>	SHEET 4 OF 6	2

$I_F$  VS.  $T_a$

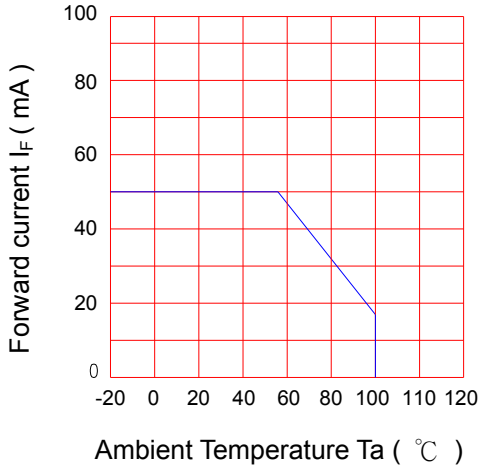

$I_T$  VS.  $T_a$

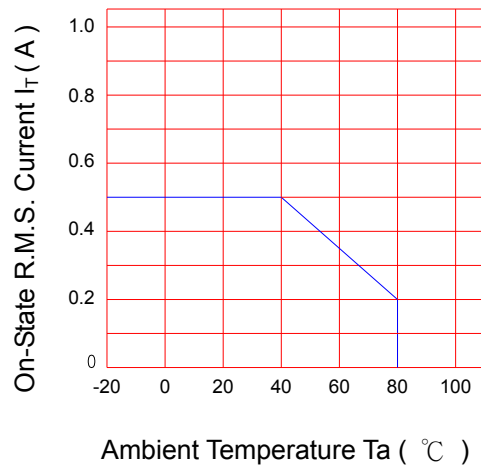

$I_{FP}$  vs. Duty Ratio

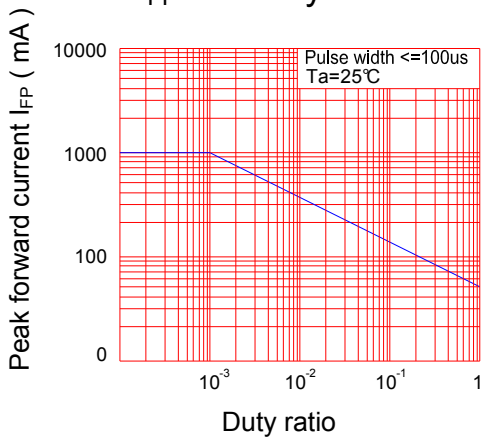

$I_F$  vs.  $V_F$

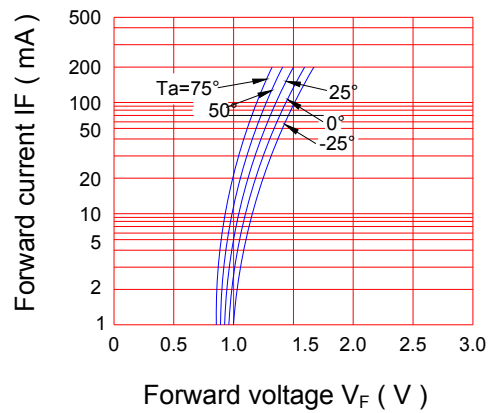

$I_{FT}$  VS.  $T_a$

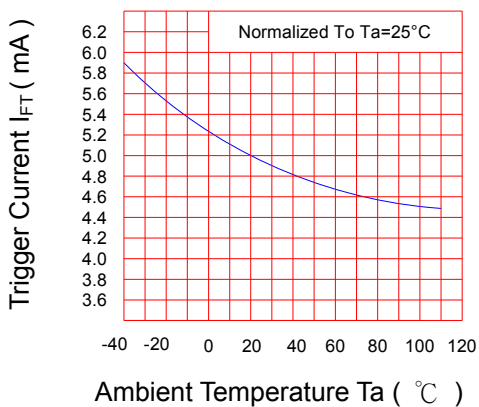

$V_{INH}$  VS.  $T_a$

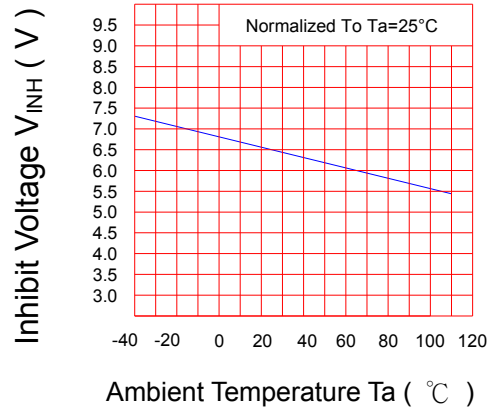

# PRODUCT SPECIFICATION

DATE : 05/21/2007

<b>cosmo</b> ELECTRONICS CORPORATION	Power Photo TRIAC : <b>KTLP3507H</b>	62P46002	REV. 2
		SHEET 5 OF 6	

$I_{TM}$  VS.  $V_{TM}$

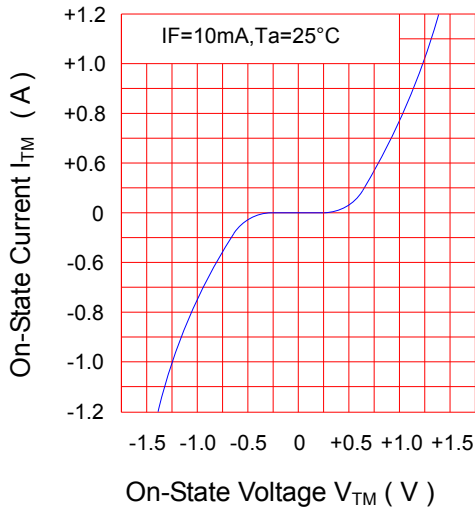

$I_{DRM}$  VS.  $T_a$

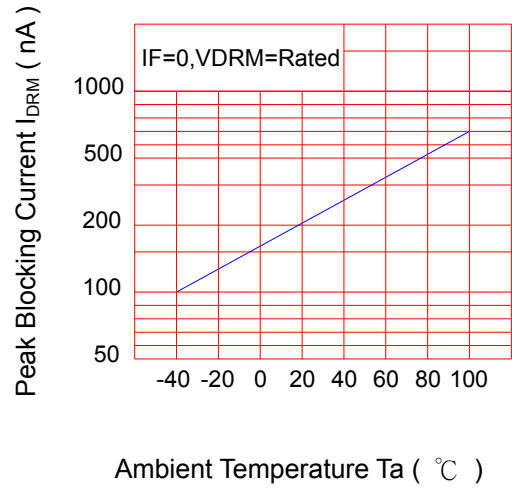

# PRODUCT SPECIFICATION

DATE : 05/21/2007

<b>cosmo</b> ELECTRONICS CORPORATION	Power Photo TRIAC :	62P46002	REV.
	<b>KTLP3507H</b>	SHEET 6 OF 6	2

## ● NOTICE

The information contained in this document is intended to be a general product description and is subject to change without notice. Please contact cosmo in order to obtain the latest device data sheets before using any cosmo device. cosmo does not assume any responsibility for use of any circuitry described. No circuit patent licenses are implied. This publication is the property of cosmo. No part of this publication may be reproduced or copied in any form or by any means, or transferred to any third party without the prior written consent of cosmo Electronics Corporation.

The devices listed in this document are designed for general applications only in electronic equipment. No devices shall be deployed which require higher level of reliability such as :

- Medical and other life support equipments.
- Space application.
- Telecommunication equipment ( trunk lines ).
- Nuclear power control equipment.

Unless it received prior written approval from cosmo.

cosmo takes no responsibility for damages arise form the improper usage of our device. Please contact cosmo for further information regarding the above notices.