

BCR16HM

MEDIUM POWER USE
INSULATED TYPE, GLASS PASSIVATION TYPE

BCR16HM

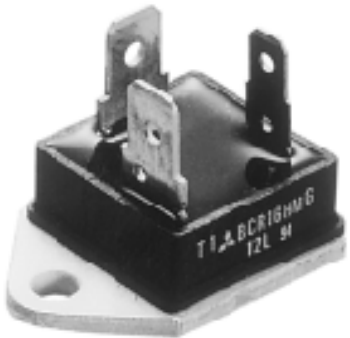

- **IT (RMS)** 16A
- **VDRM** 400V/600V
- **IFGT I , IRGT I , IRGT III** 30mA
- **Viso**..... 2200V
- **UL Recognized: File No. E80276**

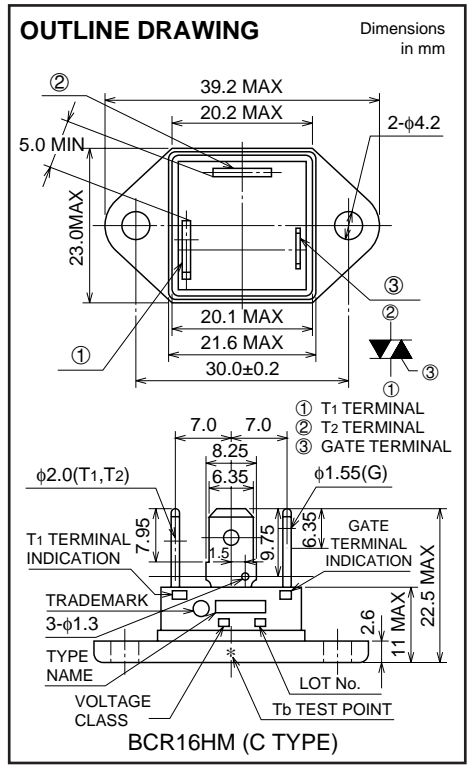

APPLICATION

Contactless AC switches, light dimmer,
on/off and speed control of small induction motors, on/off control of copier lamps,
microwave ovens

MAXIMUM RATINGS

Symbol	Parameter	Voltage class		Unit
		8	12	
VDRM	Repetitive peak off-state voltage*1	400	600	V
VDSM	Non-repetitive peak off-state voltage*1	500	720	V

Symbol	Parameter	Conditions	Ratings	Unit
IT (RMS)	RMS on-state current	Commercial frequency, sine full wave, 360° conduction, Tb=82°C	16	A
ITSM	Surge on-state current	60Hz sinewave 1 full cycle, peak value, non-repetitive	170	A
I ² t	I ² t for fusing	Value corresponding to 1 cycle of half wave 60Hz, surge on-state current	121	A ² s
PGM	Peak gate power dissipation		5	W
PG (AV)	Average gate power dissipation		0.5	W
VGM	Peak gate voltage		10	V
IGM	Peak gate current		2	A
Tj	Junction temperature		-40 ~ +125	°C
Tstg	Storage temperature		-40 ~ +125	°C
—	Mounting torque	Screw M4	15 1.47	kg-cm N-m
—	Weight		26	g
Viso	Isolation voltage	Ta=25°C, AC 1 minute, T2 · T1 · G terminal to base	2200	V

*1. Gate open.

BCR16HM

MEDIUM POWER USE
INSULATED TYPE, GLASS PASSIVATION TYPE

ELECTRICAL CHARACTERISTICS

Symbol	Parameter	Test conditions	Limits			Unit	
			Min.	Typ.	Max.		
IDRM	Repetitive peak off-state current	T _j =125°C, V _{DRM} applied	—	—	3.0	mA	
V _{TM}	On-state voltage	T _b =25°C, I _{TM} =25A, Instantaneous measurement	—	—	1.6	V	
V _{FGT I}	Gate trigger voltage *2	T _j =25°C, V _D =6V, R _L =6Ω, R _G =330Ω	I	—	—	1.5	V
V _{RGT I}			II	—	—	1.5	V
V _{RGT III}			III	—	—	1.5	V
I _{FGT I}	Gate trigger current *2	T _j =25°C, V _D =6V, R _L =6Ω, R _G =330Ω	I	—	—	30	mA
I _{RGT I}			II	—	—	30	mA
I _{RGT III}			III	—	—	30	mA
V _{GD}	Gate non-trigger voltage	T _j =125°C, V _D =1/2V _{DRM}	0.2	—	—	V	
R _{th (j-b)}	Thermal resistance	Junction to base *4	—	—	2.0	°C/W	
(dv/dt) _c	Critical-rate of rise of off-state commutating voltage		*3	—	—	V/μs	

*2. Measurement using the gate trigger characteristics measurement circuit.
 *3. The critical-rate of rise of the off-state commutating voltage is shown in the table below.
 *4. The contact thermal resistance R_{th (b-f)} in case of greasing is 0.5°C/W.

Voltage class	V _{DRM} (V)	(dv/dt) _c			Test conditions	Commutating voltage and current waveforms (inductive load)
		Symbol	Min.	Unit		
8	400	R	—	V/μs	1. Junction temperature T _j =125°C 2. Rate of decay of on-state commutating current (di/dt) _c =-8A/ms 3. Peak off-state voltage V _D =400V	
		L	10			
12	600	R	—			
		L	10			

PERFORMANCE CURVES

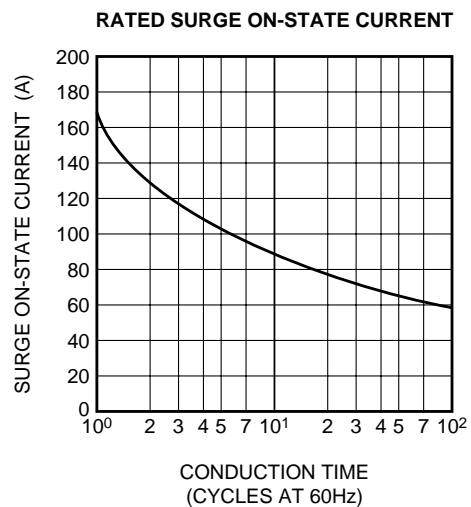
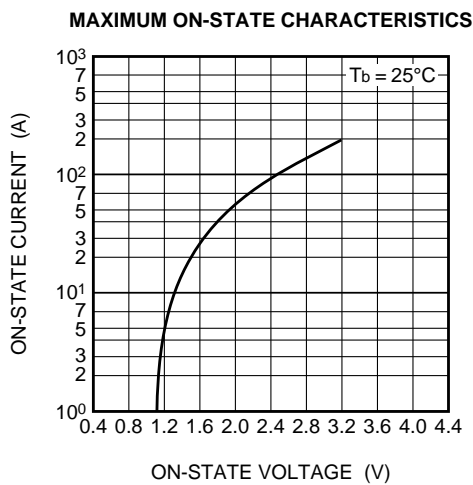

BCR16HM

MEDIUM POWER USE
INSULATED TYPE, GLASS PASSIVATION TYPE

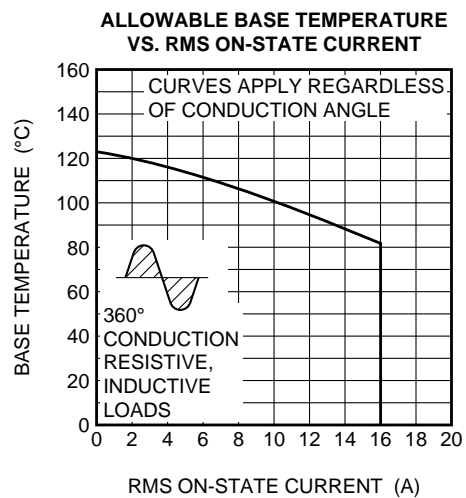
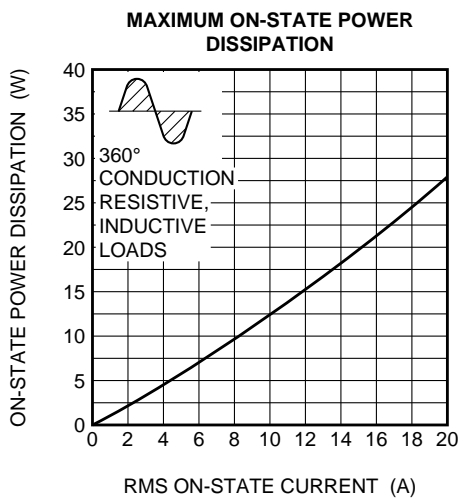
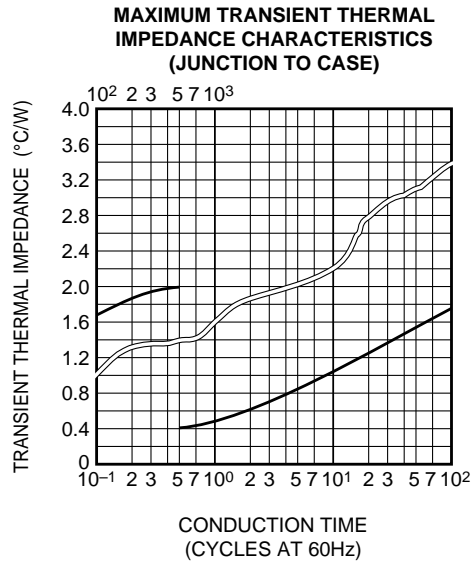
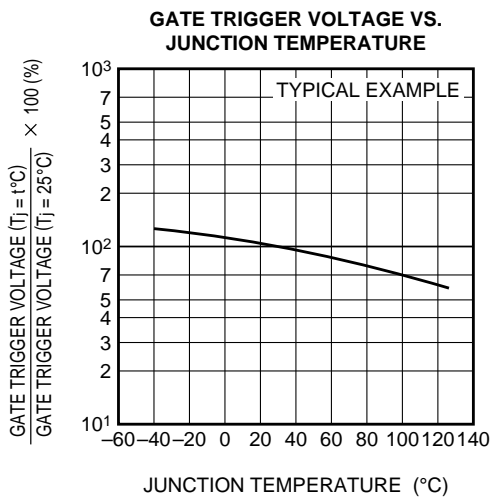
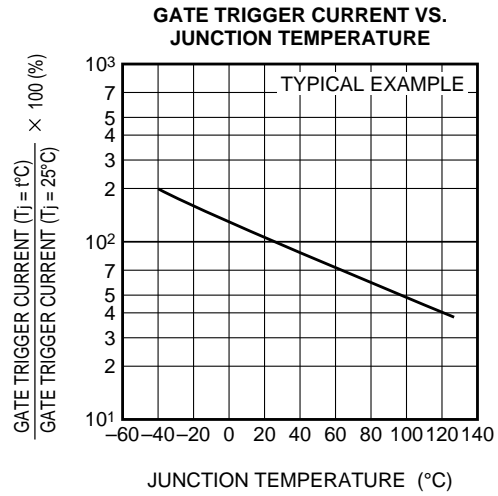
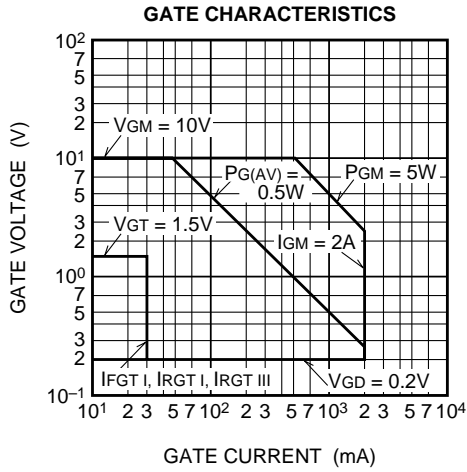

BCR16HM

MEDIUM POWER USE
INSULATED TYPE, GLASS PASSIVATION TYPE

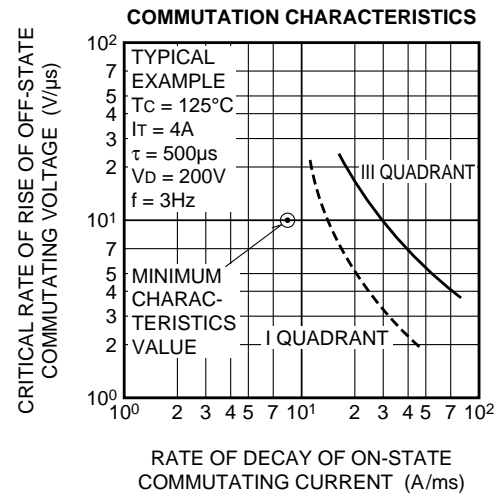
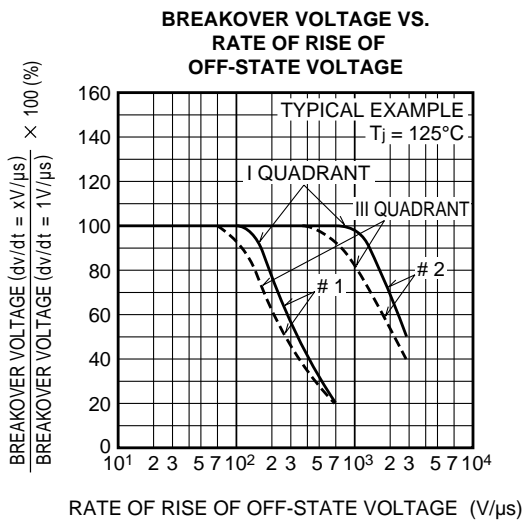
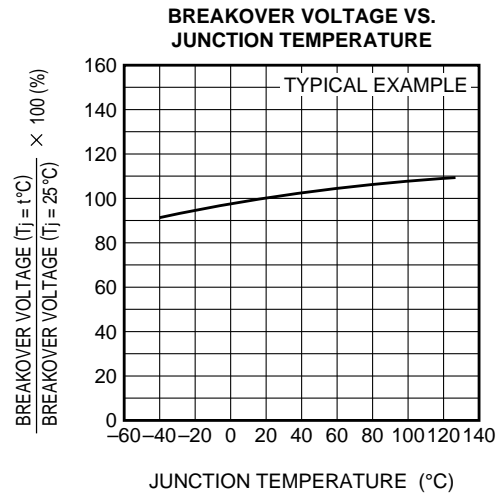
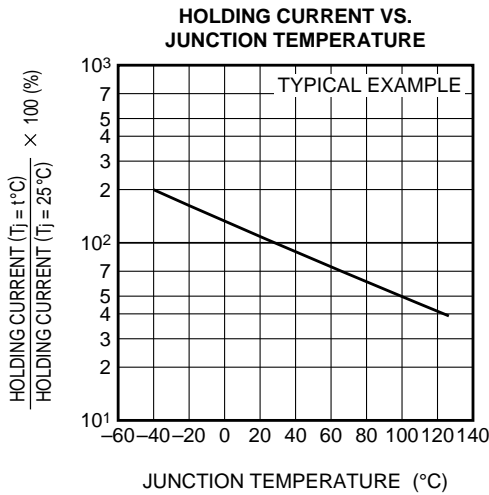
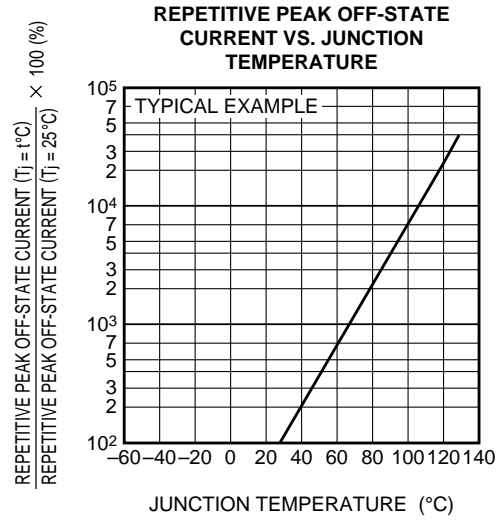
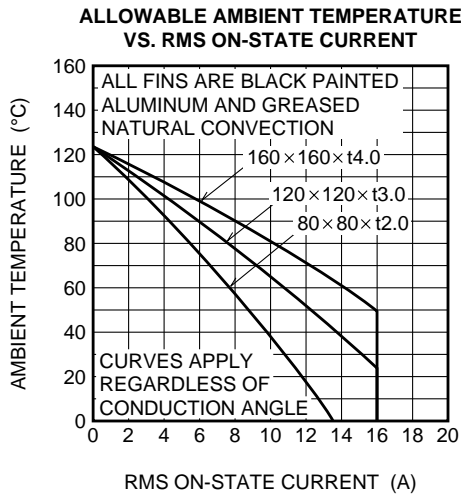

BCR16HM

MEDIUM POWER USE
INSULATED TYPE, GLASS PASSIVATION TYPE

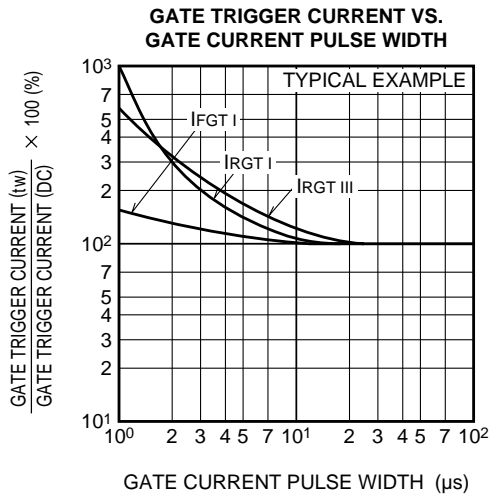

GATE TRIGGER CHARACTERISTICS TEST CIRCUITS

