

6

5

4

3



2

1

MATERIAL AND FINISH:

Insulator: Polycarbonate, UL-94V-0 rated
Contacts: Brass, Nickel plated

ELECTRICAL SPECIFICATIONS:

Current rating: 16 A 
Voltage rating: 250 VAC
Current rating: 20 A  
Voltage rating: 250 VAC
Insulation resistance: 100 Mohm min. at 500 VDC
Dielectric withstanding voltage: 2000 VAC for one minute

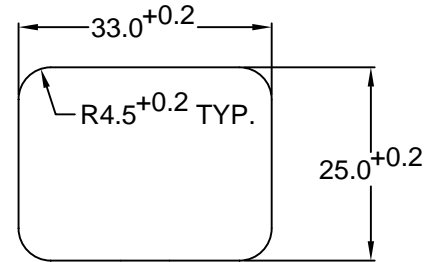
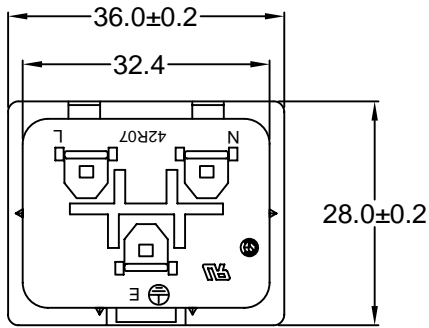

RECOMMENDED PANEL CUTOUT

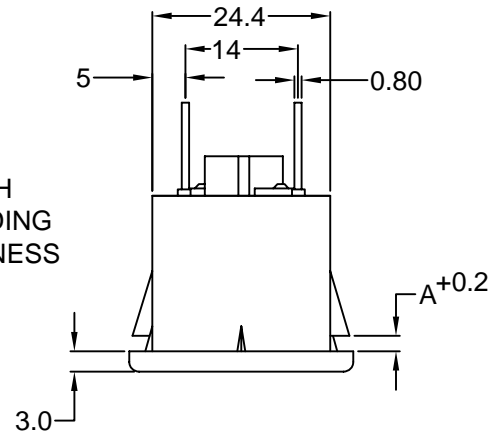
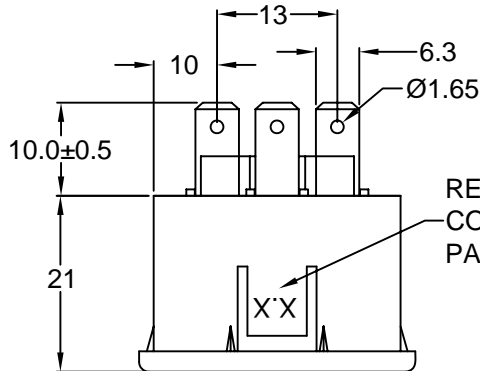



ORDERING CODE:

42R07-3 2 -
 1 2 3

1) COLOR

- 1 = BLACK
- 2 = GRAY

2) ELECTRICAL CIRCUIT CONFIGURATION

- 1 = 20A 250V 70°C 2+GROUND 
- 2 = 20A 250V 155°C 2+GROUND 
- 3 = 20A 250V 70°C 2 POLE 

3) PANEL THICKNESS

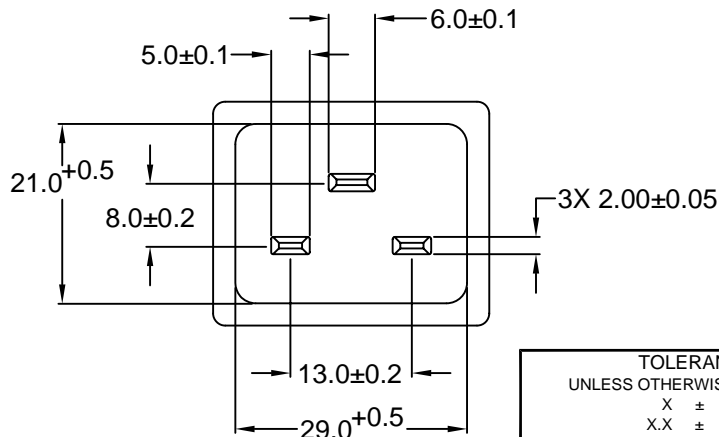

P/N	A	MAX. PANEL THICKNESS
42R07-3X2X-150	1.5	1.5
42R07-3X2X-200	2.0	2.0
42R07-3X2X-250	2.5	2.5

ADDITIONAL PANEL THICKNESS AVAILABLE ON REQUEST

TOLERANCE UNLESS OTHERWISE SPECIFIED	
X	± 1
X.X	± 0.4
X.XX	± 0.20

Power Dynamics, Inc.

Phone: 973 560-0019 Whippany, New Jersey Fax: 973 560-0076

PART: 16/20A IEC 60320 APPL. INLET; QC TERMINALS; SNAP-IN, PANEL MOUNT

DRAWN BY	GQ	DATE:	08/24/01
CHECK BY	TD	DATE:	08/29/01
APPR BY	PB	DATE:	08/29/01

PART #:	42R07-3X2X-XXX	SHEET	1 of 1
SIZE:	A	ALL DIMENSIONS FOR REFERENCE ONLY DIMENSIONS ARE IN MILLIMETERS	REV: C
SCALE:	NTS		

RoHS COMPLIANT

D

C

B

A

REV	DATE	CHANGE	CHNG CHECK	APPR	PB
A	11/24/04	ADD 13.0, 9.7, 13.6, 5.0 DIM	TD		

B	C	CHG REF DIM TO DIM	P POLE ORDERING CODE WAS 4	PB

PB	TD	PB