

8A, 600V Ultrafast Single Diode
Features

- Ultrafast recovery time $t_r < 23\text{ns}$
- Low forward voltage drop
- Low leakage current
- High reliability by planer design
- Maximum Junction Temperature Range(150°C)

General Description

Winsemi's FRD.. series are the state of the are Ultra fast recovery rectifiers specifically designed with optimized performance of forward voltage drop and ultra fast recovery time The planar structure and the platinum doped life time control, guarantee the best overall performance, ruggedness and reliability characteristics.

Applications

- Freewheeling, Snubber, Clamp
- Inversion Welder
- PFC
- Plating Power Supply
- Ultrasonic Cleaner and Welder
- Converter & Chopper
- UPS

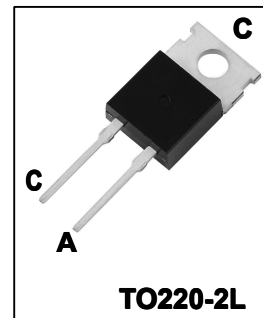
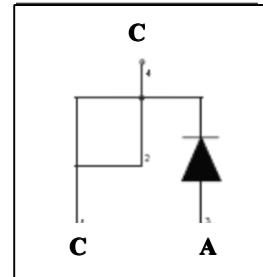
Absolute Maximum Ratings

Symbol	Parameter	Value	Units
V_{RRM}	Peak Repetitive Reverse Voltage	600	V
$I_{F(AV)}$	Average Forward Current Square wave, duty=1/2, $T_c=115^\circ\text{C}$	8	A
I_{FM}	Repetitive Peak Forward Current Square wave, 20kHz, $T_c=115^\circ\text{C}$	16	A
I_{FSM}	No-Repetitive Peak Surge Current	80	A
P_D	Power Dissipation	42	W
T_{STG}, T_J	Operating Junction Temperature & Storage Temperature	-40 to 150	$^\circ\text{C}$
Torque	Module-to-Sink , Recommended (M3)	1.1	N.m

Electrical Characteristics ($T_c=25^\circ\text{C}$ unless otherwise noted)

Symbol	Parameter	Test Conditions	Value			Units
			Min	Typ	Max	
V_F	Forward Voltage Drop	$I_F=8\text{A}$	-	1.3	1.7	V
		$I_F=8\text{A}, T_c=125^\circ\text{C}$	-	1.0	-	V
I_{RRM}	Reverse Current	$V_R=600\text{V}$	-	-	15	μA
		$V_R=600\text{V}, T_c=125^\circ\text{C}$	-	-	250	μA
t_r	Reverse Recovery Time	$I_F=1.0\text{A}, V_R=30\text{V}, di_F/dt=200\text{A}/\mu\text{s}$	-	30	-	ns
		$I_F=8.0\text{A}, V_R=300\text{V}$	-	50	-	
$R_{th(J-C)}$	Thermal Resistance		-	-	2.5	$^\circ\text{C}/\text{W}$

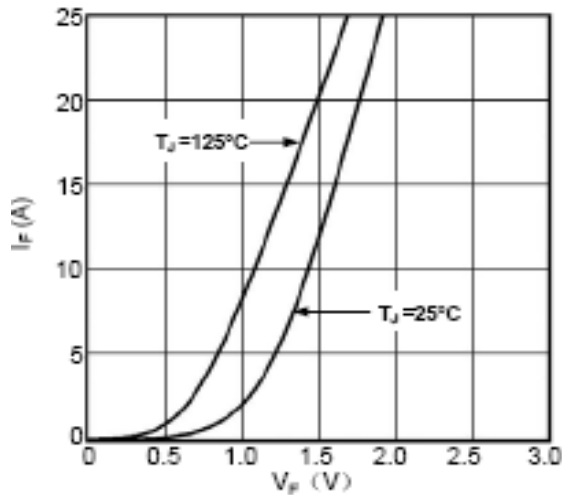

Fig1. Forward Voltage Drop vs Forward Current

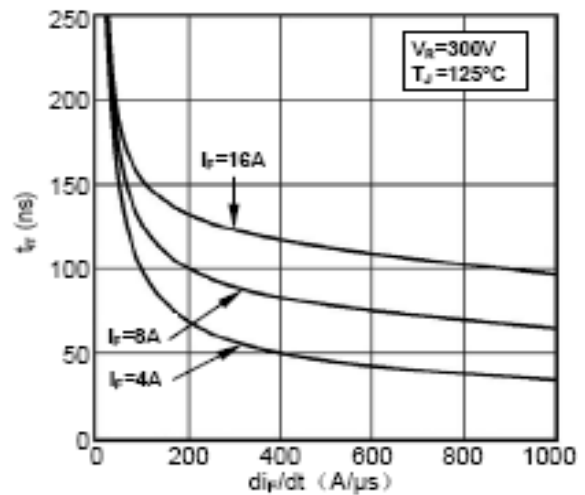

Fig2. Reverse Recovery Time vs di_F/dt

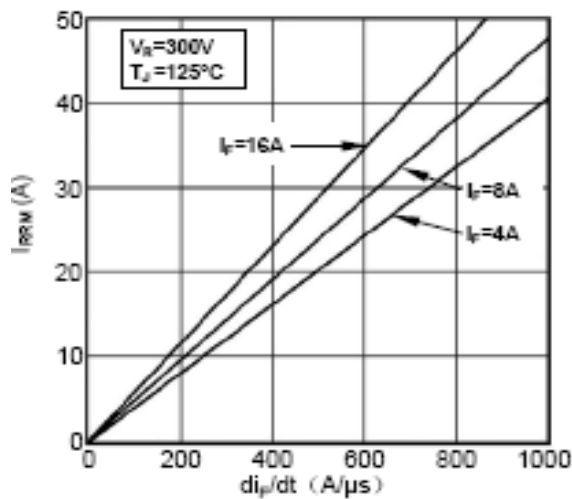

Fig3. Reverse Recovery Current vs di_F/dt

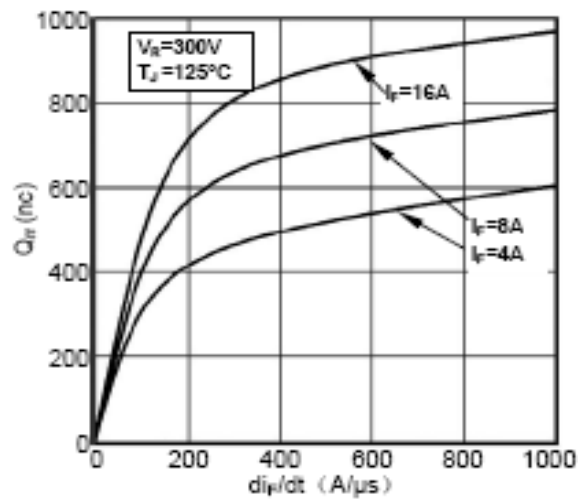

Fig4. Reverse Recovery Charge vs di_F/dt

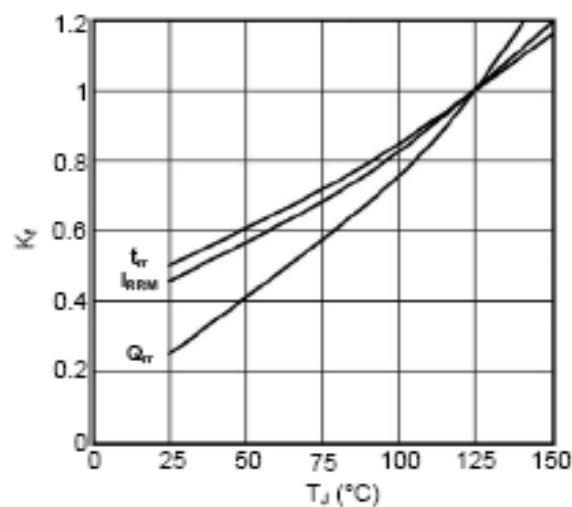

Fig5. Dynamic Parameters vs Junction Temperature

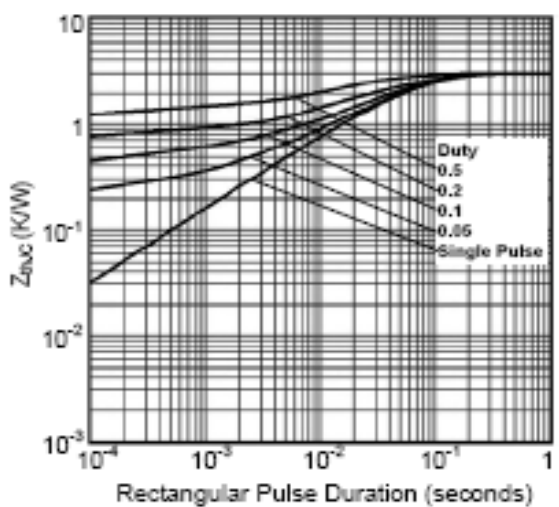

Fig6. Transient Thermal Impedance

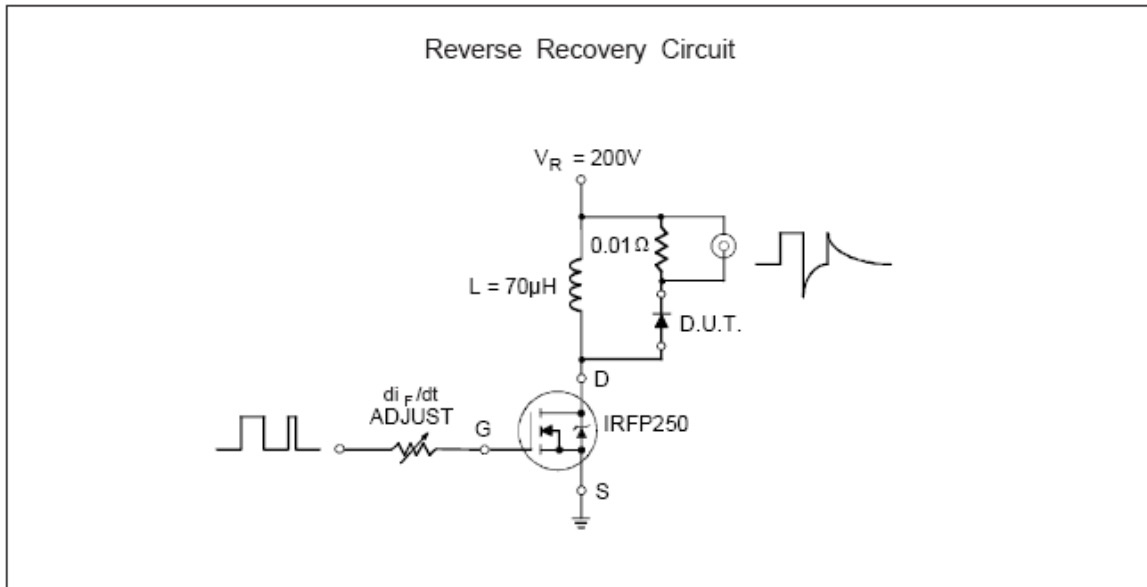

Fig.7 Reverse Recovery Parameter Test Circuit

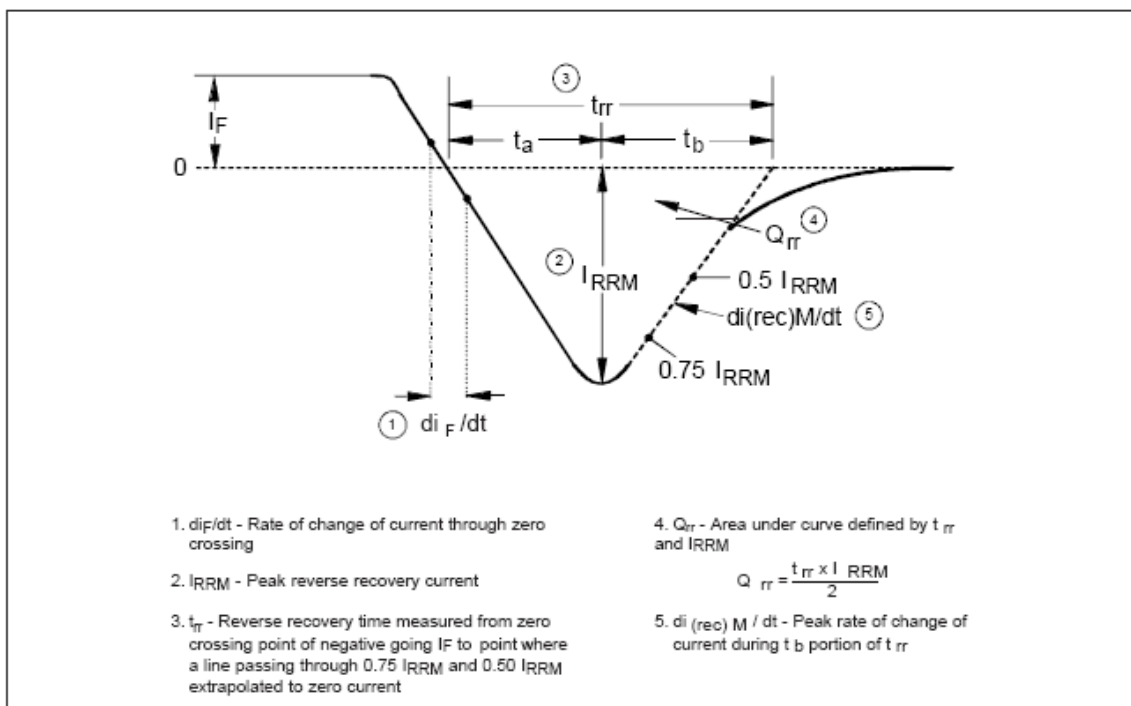

Fig.8 Reverse Recovery Waveform and Definitions

TO220-2L Package Dimension

