

## Thyristor/Diode and Thyristor/Thyristor (SUPER MAGN-A-PAK Power Modules), 430 A

**SUPER MAGN-A-PAK**
**FEATURES**

- High current capability
- High surge capability
- High voltage ratings up to 2000 V
- 3000  $V_{RMS}$  isolating voltage with non-toxic substrate
- Industrial standard package
- UL approved file E78996
- Compliant to RoHS directive 2002/95/EC

**RoHS  
COMPLIANT**
**TYPICAL APPLICATIONS**

- Motor starters
- DC motor controls - AC motor controls
- Uninterruptable power supplies
- Wind mill

**PRODUCT SUMMARY**

$I_{T(AV)}$	430 A
-------------	-------

**MAJOR RATINGS AND CHARACTERISTICS**

SYMBOL	CHARACTERISTICS	VALUES	UNITS
$I_{T(AV)}$	82 °C	430	A
$I_{T(RMS)}$		675	A
	$T_C$	82	°C
$I_{TSM}$	50 Hz	15.7	kA
	60 Hz	16.4	
$I^2t$	50 Hz	1232	kA <sup>2</sup> s
	60 Hz	1125	
$I^2\sqrt{t}$		12 320	kA <sup>2</sup> √s
$V_{RRM}$	Range	1600 to 2000	V
$T_J$	Range	- 40 to 150	°C
$T_{Stg}$		- 40 to 130	

**ELECTRICAL SPECIFICATIONS**
**VOLTAGE RATINGS**

TYPE NUMBER	VOLTAGE CODE	$V_{RRM}/V_{DRM}$ , MAXIMUM REPETITIVE PEAK REVERSE VOLTAGE V	$V_{RSM}$ , MAXIMUM NON-REPETITIVE PEAK REVERSE VOLTAGE V	$I_{RRM}/I_{DRM}$ MAXIMUM AT $T_J = T_J$ MAXIMUM mA
VSK.430..	16	1600	1700	100
	18	1800	1900	
	20	2000	2100	

ON-STATE CONDUCTION					
PARAMETER	SYMBOL	TEST CONDITIONS		VALUES	UNITS
Maximum average on-state current at case temperature	$I_{T(AV)}$ , $I_{F(AV)}$	180° conduction, half sine wave		430	A
				82	°C
Maximum RMS on-state current	$I_{T(RMS)}$	180° conduction, half sine wave at $T_C = 82\text{ °C}$		675	A
Maximum peak, one-cycle, non-repetitive surge current	$I_{TSM}$ , $I_{FSM}$	$t = 10\text{ ms}$	No voltage reapplied	Sinusoidal half wave, initial $T_J = T_J$ maximum	kA
		$t = 8.3\text{ ms}$			
		$t = 10\text{ ms}$	100 % $V_{RRM}$ reapplied		
		$t = 8.3\text{ ms}$			
Maximum $I^2t$ for fusing	$I^2t$	$t = 10\text{ ms}$	No voltage reapplied		kA <sup>2</sup> s
		$t = 8.3\text{ ms}$			
		$t = 10\text{ ms}$	100 % $V_{RRM}$ reapplied		
		$t = 8.3\text{ ms}$			
Maximum $I^2\sqrt{t}$ for fusing	$I^2\sqrt{t}$	$t = 0.1\text{ ms}$ to $10\text{ ms}$ , no voltage reapplied		12 320	kA <sup>2</sup> √s
Low level value of threshold voltage	$V_{F(TO)1}$	$(16.7\% \times \pi \times I_{T(AV)} < I < \pi \times I_{T(AV)})$ , $T_J = T_J$ maximum		0.96	V
High level value of threshold voltage	$V_{F(TO)2}$	$(I > \pi \times I_{T(AV)})$ , $T_J = T_J$ maximum		1.06	
Low level value of on-state slope resistance	$r_{f1}$	$(16.7\% \times \pi \times I_{T(AV)} < I < \pi \times I_{T(AV)})$ , $T_J = T_J$ maximum		0.51	mΩ
High level value of on-state slope resistance	$r_{f2}$	$(I > \pi \times I_{T(AV)})$ , $T_J = T_J$ maximum		0.45	
Maximum on-state voltage drop	$V_{TM}$	$I_{pk} = 1500\text{ A}$ , $T_J = 25\text{ °C}$ , $t_p = 10\text{ ms}$ sine pulse		1.65	V
Maximum forward voltage drop	$V_{FM}$	$I_{pk} = 1500\text{ A}$ , $T_J = 25\text{ °C}$ , $t_p = 10\text{ ms}$ sine pulse		1.65	V
Maximum holding current	$I_H$	$T_J = 25\text{ °C}$ , anode supply 12 V resistive load		500	mA
Typical latching current	$I_L$			1000	

SWITCHING					
PARAMETER	SYMBOL	TEST CONDITIONS		VALUES	UNITS
Maximum rate of rise of turned-on current	$di/dt$	$T_J = T_J$ maximum, $I_{TM} = 400\text{ A}$ , $V_{DRM}$ applied		1000	A/μs
Typical delay time	$t_d$	Gate current 1 A, $di_g/dt = 1\text{ A}/\mu\text{s}$ $V_d = 0.67\% V_{DRM}$ , $T_J = 25\text{ °C}$		2.0	μs
Typical turn-off time	$t_q$	$I_{TM} = 750\text{ A}$ , $T_J = T_J$ maximum, $di/dt = -60\text{ A}/\mu\text{s}$ $V_R = 50$ , $dV/dt = 20\text{ V}/\mu\text{s}$ , Gate 0 V 100 Ω		200	

BLOCKING					
PARAMETER	SYMBOL	TEST CONDITIONS		VALUES	UNITS
Maximum critical rate of rise of off-state voltage	$dV/dt$	$T_J = 130\text{ °C}$ , linear to $V_D = 80\% V_{DRM}$		1000	V/μs
RMS insulation voltage	$V_{INS}$	$t = 1\text{ s}$		3000	V
Maximum peak reverse and off-state leakage current	$I_{RRM}$ , $I_{DRM}$	$T_J = T_J$ maximum, rated $V_{DRM}/V_{RRM}$ applied		100	mA



<b>THERMAL AND MECHANICAL SPECIFICATIONS</b>				
PARAMETER	SYMBOL	TEST CONDITIONS	VALUES	UNITS
Maximum junction operating temperature range	$T_J$		- 40 to 130	°C
Maximum storage temperature range	$T_{Stg}$		- 40 to 150	
Maximum thermal resistance, junction to case per junction	$R_{thJC}$	DC operation	0.065	K/W
Maximum thermal resistance, case to heatsink	$R_{thC-hs}$		0.02	
Mounting torque $\pm 10\%$	SMAP to heatsink	A mounting compound is recommended and the torque should be rechecked after a period of 3 hours to allow for the spread of the compound.	6 to 8	Nm
	busbar to SMAP		12 to 15	
Approximate weight			1500	g
Case style		See dimensions - link at the end of datasheet	SUPER MAGN-A-PAK	

<b><math>\Delta R_{thJC}</math> CONDUCTION</b>				
CONDUCTION ANGLE	SINUSOIDAL CONDUCTION	RECTANGULAR CONDUCTION	TEST CONDITIONS	UNITS
180°	0.009	0.006	$T_J = T_J$ maximum	K/W
120°	0.011	0.011		
90°	0.014	0.015		
60°	0.021	0.022		
30°	0.037	0.038		

**Note**

- The table above shows the increment of thermal resistance  $R_{thJC}$  when devices operate at different conduction angles than DC

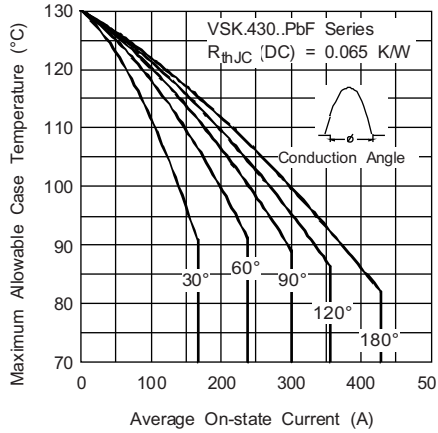

Fig. 1 - Current Ratings Characteristics

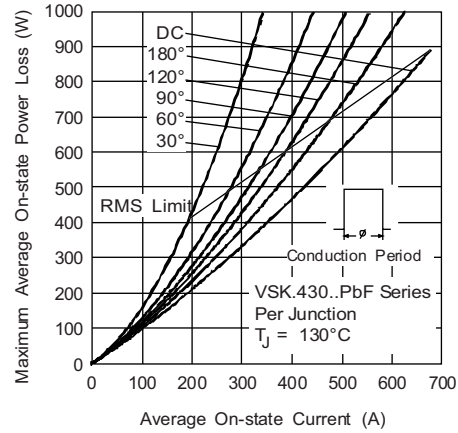

Fig. 4 - On-State Power Loss Characteristics

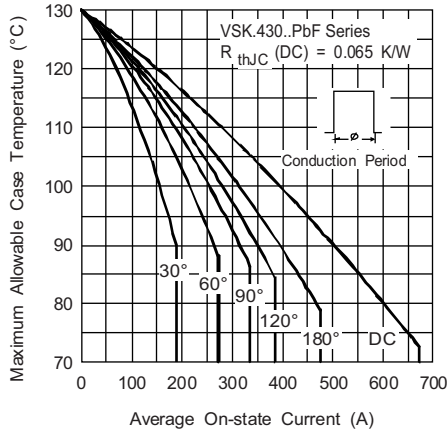

Fig. 2 - Current Ratings Characteristics

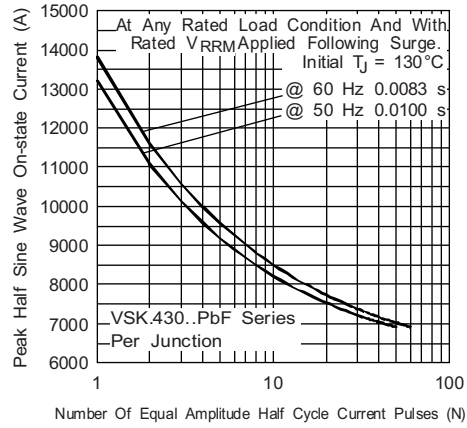

Fig. 5 - Maximum Non-Repetitive Surge Current

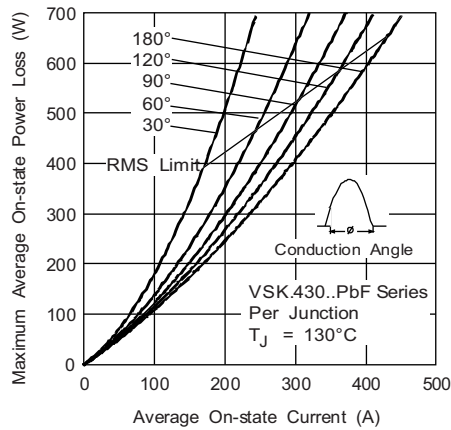

Fig. 3 - On-State Power Loss Characteristics

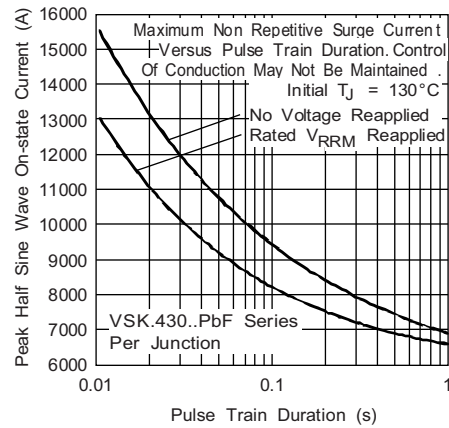

Fig. 6 - Maximum Non-Repetitive Surge Current

## Thyristor/Diode and Thyristor/Thyristor Vishay Semiconductors (SUPER MAGN-A-PAK Power Modules), 430 A

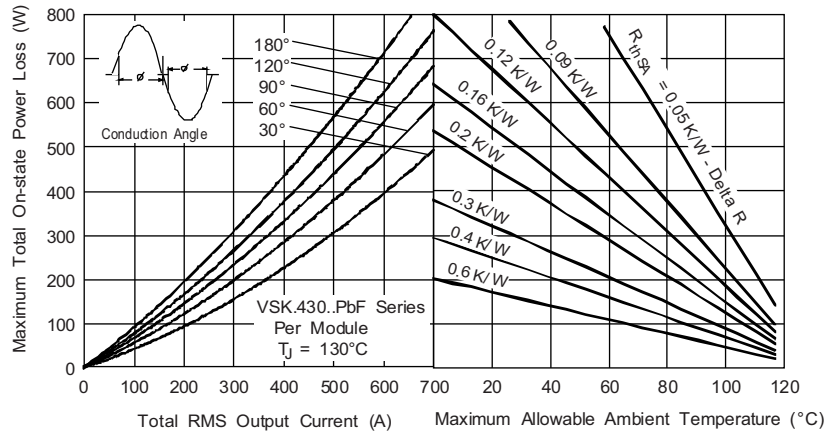

Fig. 7 - On-State Power Loss Characteristics

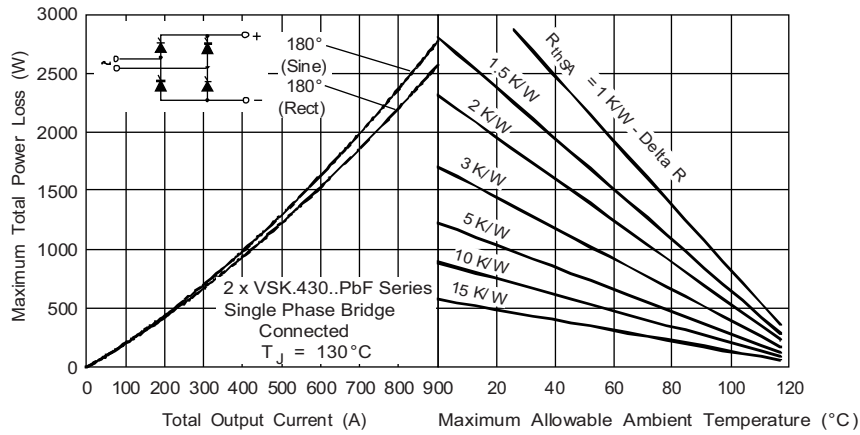

Fig. 8 - On-State Power Loss Characteristics

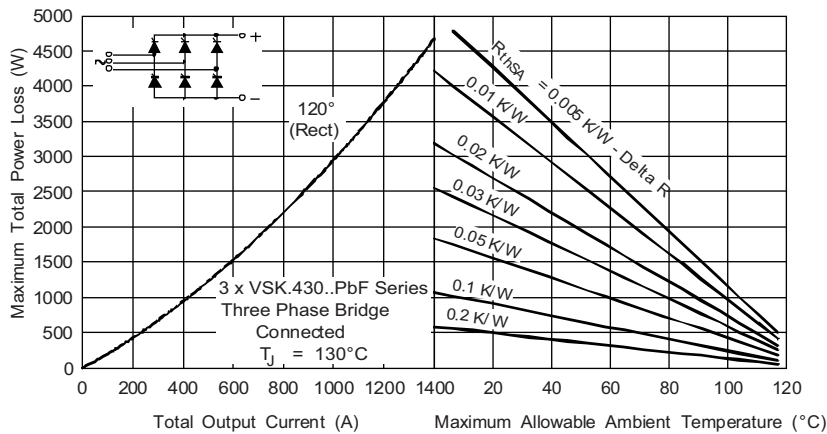

Fig. 9 - On-State Power Loss Characteristics

# VSK.430..PbF Series



Vishay Semiconductors Thyristor/Diode and Thyristor/Thyristor  
(SUPER MAGN-A-PAK Power Modules), 430 A

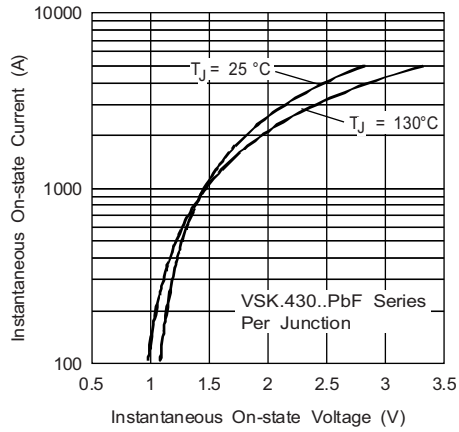

Fig. 10 - On-State Voltage Drop Characteristics

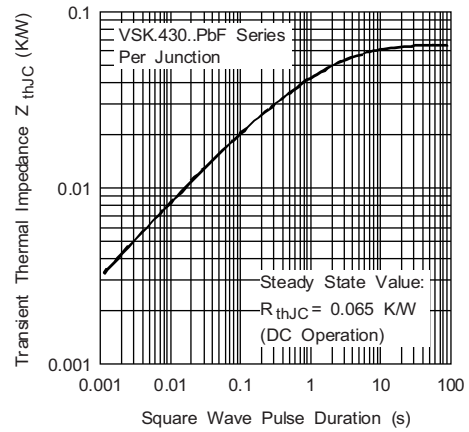

Fig. 11 - Thermal Impedance  $Z_{thJC}$  Characteristics

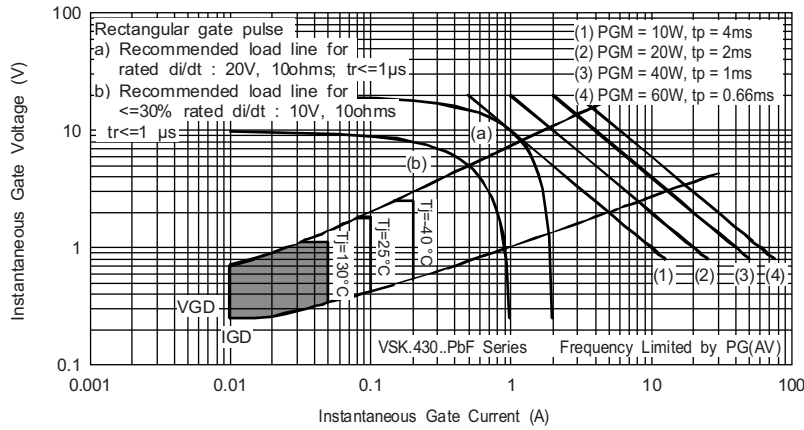

Fig. 12 - Gate Characteristics

## ORDERING INFORMATION TABLE

Device code	<b>VSK</b>	<b>T</b>	<b>430</b>	<b>-</b>	<b>20</b>	<b>PbF</b>	
	①	②	③		④	⑤	
	1	-	Module type		2	-	
		2	-	Circuit configuration (see end of datasheet)		3	-
			3	-	4	-	
				4	-	Voltage code x 100 = $V_{RRM}$ (see Voltage Ratings table)	
					5	-	
						Lead (Pb)-free	

### Note

- To order the optional hardware go to [www.vishay.com/doc?95172](http://www.vishay.com/doc?95172)



**CIRCUIT CONFIGURATION**

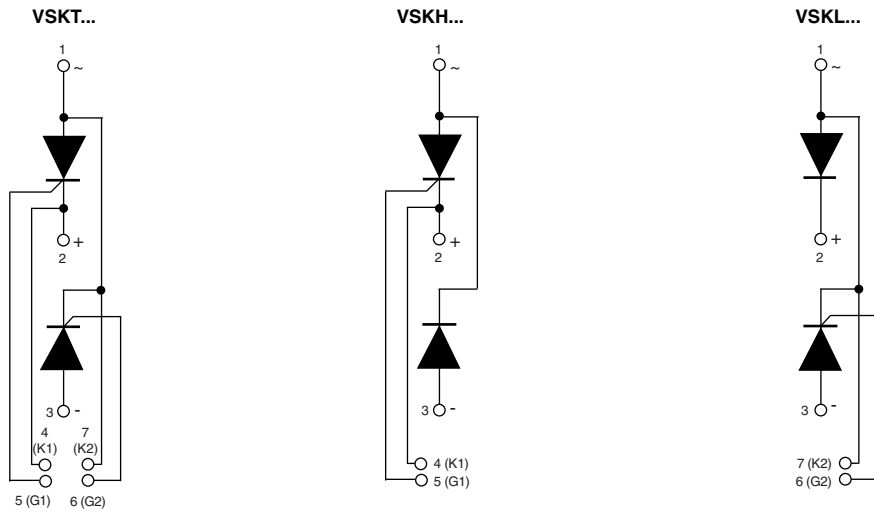

LINKS TO RELATED DOCUMENTS	
Dimensions	<a href="http://www.vishay.com/doc?95283">www.vishay.com/doc?95283</a>

## Super MAGN-A-PAK Thyristor/Diode

**DIMENSIONS** in millimeters (inches)

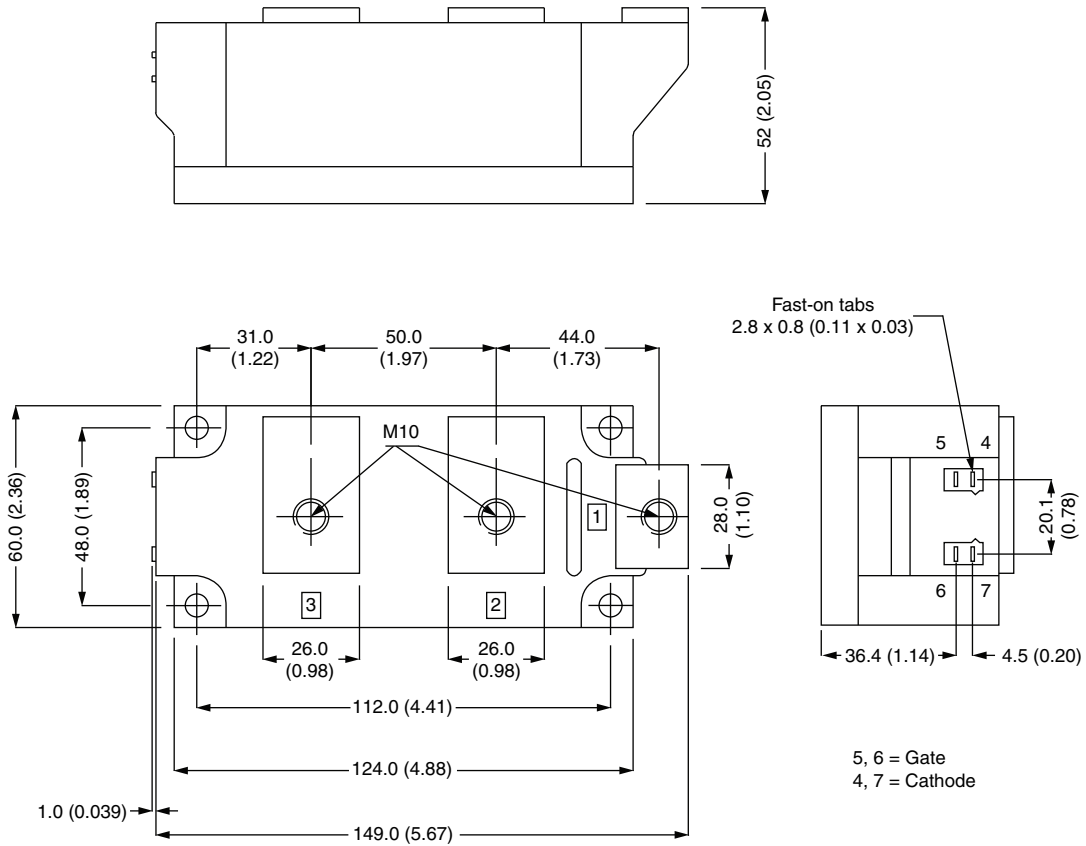





## Disclaimer

ALL PRODUCT, PRODUCT SPECIFICATIONS AND DATA ARE SUBJECT TO CHANGE WITHOUT NOTICE TO IMPROVE RELIABILITY, FUNCTION OR DESIGN OR OTHERWISE.

Vishay Intertechnology, Inc., its affiliates, agents, and employees, and all persons acting on its or their behalf (collectively, "Vishay"), disclaim any and all liability for any errors, inaccuracies or incompleteness contained in any datasheet or in any other disclosure relating to any product.

Vishay makes no warranty, representation or guarantee regarding the suitability of the products for any particular purpose or the continuing production of any product. To the maximum extent permitted by applicable law, Vishay disclaims (i) any and all liability arising out of the application or use of any product, (ii) any and all liability, including without limitation special, consequential or incidental damages, and (iii) any and all implied warranties, including warranties of fitness for particular purpose, non-infringement and merchantability.

Statements regarding the suitability of products for certain types of applications are based on Vishay's knowledge of typical requirements that are often placed on Vishay products in generic applications. Such statements are not binding statements about the suitability of products for a particular application. It is the customer's responsibility to validate that a particular product with the properties described in the product specification is suitable for use in a particular application. Parameters provided in datasheets and/or specifications may vary in different applications and performance may vary over time. All operating parameters, including typical parameters, must be validated for each customer application by the customer's technical experts. Product specifications do not expand or otherwise modify Vishay's terms and conditions of purchase, including but not limited to the warranty expressed therein.

Except as expressly indicated in writing, Vishay products are not designed for use in medical, life-saving, or life-sustaining applications or for any other application in which the failure of the Vishay product could result in personal injury or death. Customers using or selling Vishay products not expressly indicated for use in such applications do so at their own risk and agree to fully indemnify and hold Vishay and its distributors harmless from and against any and all claims, liabilities, expenses and damages arising or resulting in connection with such use or sale, including attorneys fees, even if such claim alleges that Vishay or its distributor was negligent regarding the design or manufacture of the part. Please contact authorized Vishay personnel to obtain written terms and conditions regarding products designed for such applications.

No license, express or implied, by estoppel or otherwise, to any intellectual property rights is granted by this document or by any conduct of Vishay. Product names and markings noted herein may be trademarks of their respective owners.