

PDTC123T series

NPN resistor-equipped transistors; R1 = 2.2 k Ω , R2 = open

Rev. 01 — 10 March 2006

Product data sheet

1. Product profile

1.1 General description

NPN Resistor-Equipped Transistors (RET) family in Surface Mounted Device (SMD) plastic packages.

Table 1. Product overview

Type number	Package			PNP complement
	Philips	JEITA	JEDEC	
PDTC123TE	SOT416	SC-75	-	PDTA123TE
PDTC123TK	SOT346	SC-59A	TO-236	PDTA123TK
PDTC123TM	SOT883	SC-101	-	PDTA123TM
PDTC123TS ^[1]	SOT54	SC-43A	TO-92	PDTA123TS
PDTC123TT	SOT23	-	TO-236AB	PDTA123TT
PDTC123TU	SOT323	SC-70	-	PDTA123TU

[1] Also available in SOT54A and SOT54 variant packages (see [Section 2](#)).

1.2 Features

- Built-in bias resistors
- Simplifies circuit design
- 100 mA output current capability
- Reduces component count
- Reduces pick and place costs

1.3 Applications

- Digital applications
- Control of IC inputs
- Cost-saving alternative for BC847 series in digital applications
- Switching loads

1.4 Quick reference data

Table 2. Quick reference data

Symbol	Parameter	Conditions	Min	Typ	Max	Unit
V _{CEO}	collector-emitter voltage	open base	-	-	50	V
I _O	output current		-	-	100	mA
R1	bias resistor 1 (input)		1.54	2.2	2.86	k Ω

PHILIPS

2. Pinning information

Table 3. Pinning

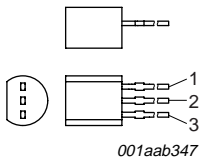
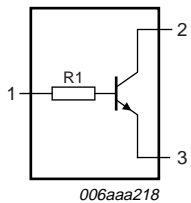
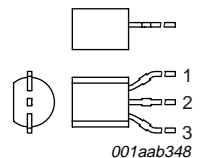
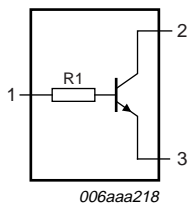
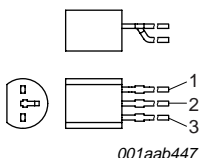
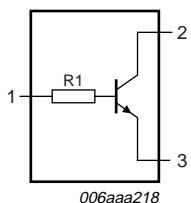
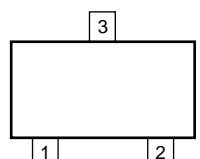
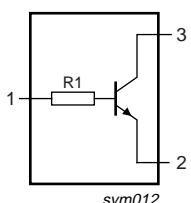
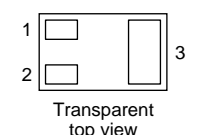
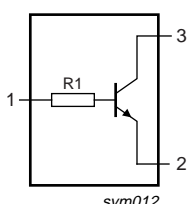
Pin	Description	Simplified outline	Symbol
SOT54			
1	input (base)	 <p>001aab347</p>	 <p>006aaa218</p>
2	output (collector)		
3	GND (emitter)		
SOT54A			
1	input (base)	 <p>001aab348</p>	 <p>006aaa218</p>
2	output (collector)		
3	GND (emitter)		
SOT54 variant			
1	input (base)	 <p>001aab447</p>	 <p>006aaa218</p>
2	output (collector)		
3	GND (emitter)		
SOT23; SOT323; SOT346; SOT416			
1	input (base)	 <p>006aaa144</p>	 <p>sym012</p>
2	GND (emitter)		
3	output (collector)		
SOT883			
1	input (base)	 <p>Transparent top view</p>	 <p>sym012</p>
2	GND (emitter)		
3	output (collector)		

3. Ordering information

Table 4. Ordering information

Type number	Package		Version
	Name	Description	
PDTC123TE	SC-75	plastic surface mounted package; 3 leads	SOT416
PDTC123TK	SC-59A	plastic surface mounted package; 3 leads	SOT346
PDTC123TM	SC-101	leadless ultra small plastic package; 3 solder lands; body 1.0 × 0.6 × 0.5 mm	SOT883
PDTC123TS ^[1]	SC-43A	plastic single-ended leaded (through hole) package; 3 leads	SOT54
PDTC123TT	-	plastic surface mounted package; 3 leads	SOT23
PDTC123TU	SC-70	plastic surface mounted package; 3 leads	SOT323

[1] Also available in SOT54A and SOT54 variant packages (see [Section 2](#) and [Section 9](#)).

4. Marking

Table 5. Marking codes

Type number	Marking code ^[1]
PDTC123TE	2B
PDTC123TK	GB
PDTC123TM	FB
PDTC123TS	TC123T
PDTC123TT	ZM*
PDTC123TU	*1T

[1] * = -: made in Hong Kong
 * = p: made in Hong Kong
 * = t: made in Malaysia
 * = W: made in China

5. Limiting values

Table 6. Limiting values

In accordance with the Absolute Maximum Rating System (IEC 60134).

Symbol	Parameter	Conditions	Min	Max	Unit
V_{CBO}	collector-base voltage	open emitter	-	50	V
V_{CEO}	collector-emitter voltage	open base	-	50	V
V_{EBO}	emitter-base voltage	open collector	-	5	V
I_O	output current		-	100	mA
I_{CM}	peak collector current	single pulse; $t_p \leq 1$ ms	-	100	mA
P_{tot}	total power dissipation	$T_{amb} \leq 25$ °C			
	SOT416		[1] -	150	mW
	SOT346		[1] -	250	mW
	SOT883		[2][3] -	250	mW
	SOT54		[1] -	500	mW
	SOT23		[1] -	250	mW
	SOT323		[1] -	200	mW
T_{stg}	storage temperature		-65	+150	°C
T_j	junction temperature		-	150	°C
T_{amb}	ambient temperature		-65	+150	°C

[1] Device mounted on an FR4 Printed-Circuit Board (PCB), single-sided copper, tin-plated and standard footprint.

[2] Reflow soldering is the only recommended soldering method.

[3] Device mounted on an FR4 PCB with 60 μm copper strip line, standard footprint.

6. Thermal characteristics

Table 7. Thermal characteristics

Symbol	Parameter	Conditions	Min	Typ	Max	Unit
$R_{th(j-a)}$	thermal resistance from junction to ambient	in free air				
	SOT416		[1] -	-	833	K/W
	SOT346		[1] -	-	500	K/W
	SOT883		[2][3] -	-	500	K/W
	SOT54		[1] -	-	250	K/W
	SOT23		[1] -	-	500	K/W
	SOT323		[1] -	-	625	K/W

[1] Device mounted on an FR4 PCB, single-sided copper, tin-plated and standard footprint.

[2] Reflow soldering is the only recommended soldering method.

[3] Device mounted on an FR4 PCB with 60 μm copper strip line, standard footprint.

7. Characteristics

Table 8. Characteristics

T_{amb} = 25 °C unless otherwise specified.

Symbol	Parameter	Conditions	Min	Typ	Max	Unit
I _{CBO}	collector-base cut-off current	V _{CB} = 50 V; I _E = 0 A	-	-	100	nA
I _{CEO}	collector-emitter cut-off current	V _{CE} = 30 V; I _B = 0 A	-	-	1	μA
		V _{CE} = 30 V; I _B = 0 A; T _J = 150 °C	-	-	50	μA
I _{EBO}	emitter-base cut-off current	V _{EB} = 5 V; I _C = 0 A	-	-	100	nA
h _{FE}	DC current gain	V _{CE} = 5 V; I _C = 20 mA	30	-	-	
V _{CEsat}	collector-emitter saturation voltage	I _C = 10 mA; I _B = 0.5 mA	-	-	150	mV
R1	bias resistor 1 (input)		1.54	2.2	2.86	kΩ
C _c	collector capacitance	V _{CB} = 10 V; I _E = i _e = 0 A; f = 1 MHz	-	-	2.5	pF

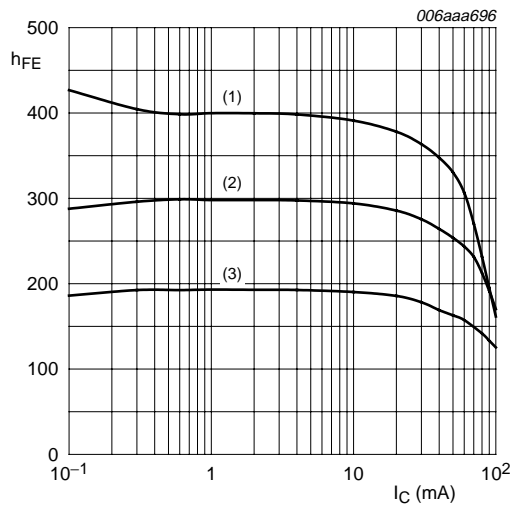

V_{CE} = 5 V
 (1) T_{amb} = 100 °C
 (2) T_{amb} = 25 °C
 (3) T_{amb} = -40 °C

Fig 1. DC current gain as a function of collector current; typical values

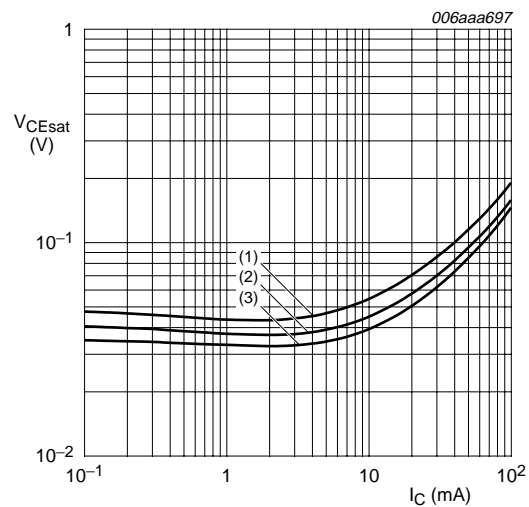

I_C/I_B = 20
 (1) T_{amb} = 100 °C
 (2) T_{amb} = 25 °C
 (3) T_{amb} = -40 °C

Fig 2. Collector-emitter saturation voltage as a function of collector current; typical values

8. Package outline

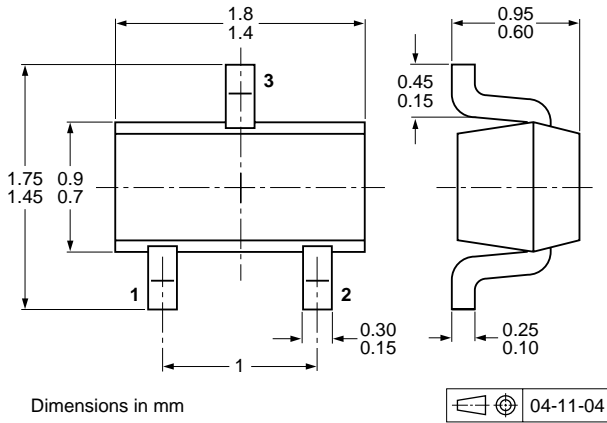

Fig 3. Package outline SOT416 (SC-75)

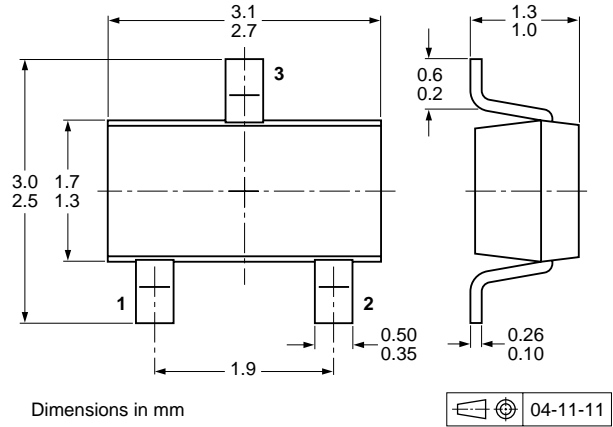

Fig 4. Package outline SOT346 (SC-59A/TO-236)

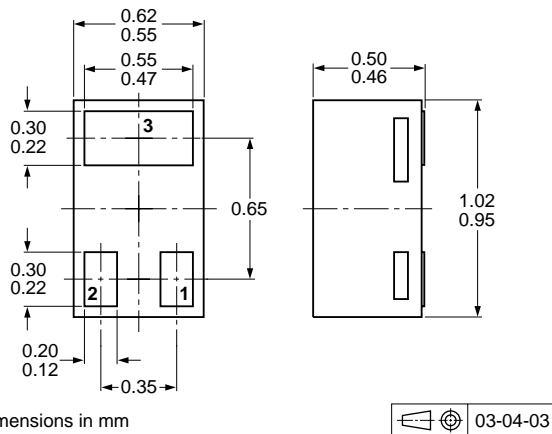

Fig 5. Package outline SOT883 (SC-101)

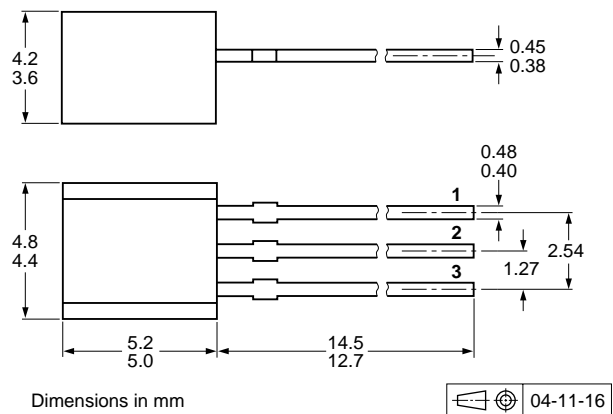

Fig 6. Package outline SOT54 (SC-43A/TO-92)

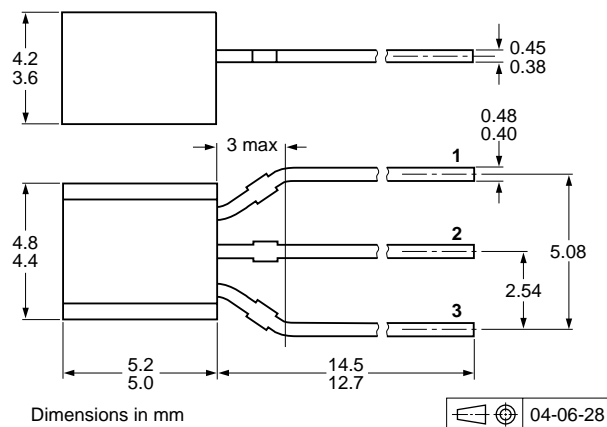

Fig 7. Package outline SOT54A

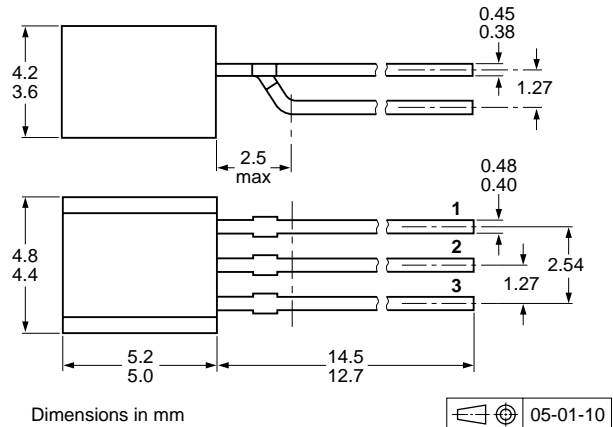
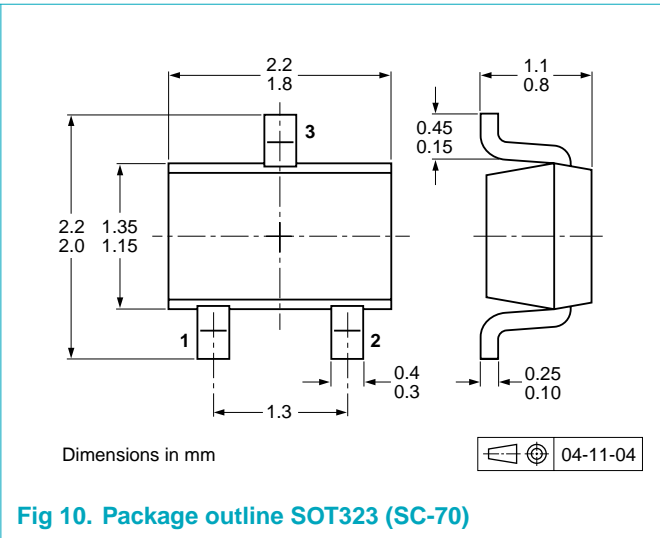
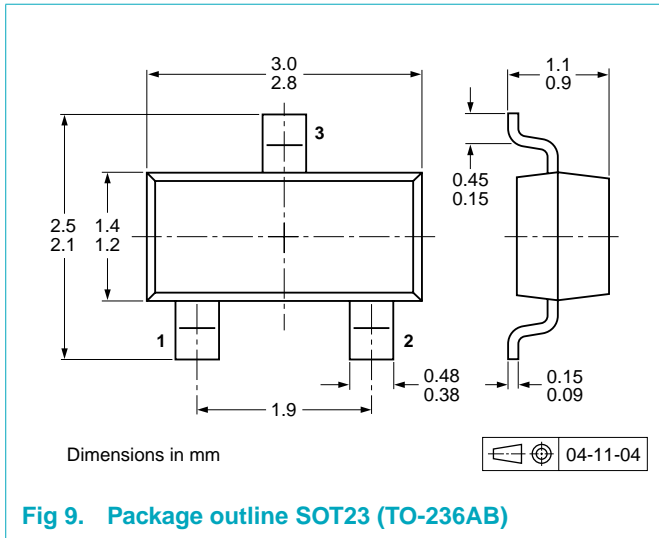

Fig 8. Package outline SOT54 variant



9. Packing information

Table 9. Packing methods

The indicated -xxx are the last three digits of the 12NC ordering code.^[1]

Type number	Package	Description	Packing quantity		
			3000	5000	10000
PDTC123TE	SOT416	4 mm pitch, 8 mm tape and reel	-115	-	-135
PDTC123TK	SOT346	4 mm pitch, 8 mm tape and reel	-115	-	-135
PDTC123TM	SOT883	2 mm pitch, 8 mm tape and reel	-	-	-315
PDTC123TS	SOT54	bulk, straight leads	-	-412	-
	SOT54A	tape and reel, wide pitch	-	-	-116
		tape ammpack, wide pitch	-	-	-126
	SOT54 variant	bulk, delta pinning	-	-112	-
PDTC123TT	SOT23	4 mm pitch, 8 mm tape and reel	-215	-	-235
PDTC123TU	SOT323	4 mm pitch, 8 mm tape and reel	-115	-	-135

[1] For further information and the availability of packing methods, see [Section 12](#).

10. Revision history

Table 10. Revision history

Document ID	Release date	Data sheet status	Change notice	Supersedes
PDTC123T_SER_1	20060310	Product data sheet	-	-

11. Legal information

11.1 Data sheet status

Document status ^{[1][2]}	Product status ^[3]	Definition
Objective [short] data sheet	Development	This document contains data from the objective specification for product development.
Preliminary [short] data sheet	Qualification	This document contains data from the preliminary specification.
Product [short] data sheet	Production	This document contains the product specification.

[1] Please consult the most recently issued document before initiating or completing a design.

[2] The term 'short data sheet' is explained in section "Definitions".

[3] The product status of device(s) described in this document may have changed since this document was published and may differ in case of multiple devices. The latest product status information is available on the Internet at URL <http://www.semiconductors.philips.com>.

11.2 Definitions

Draft — The document is a draft version only. The content is still under internal review and subject to formal approval, which may result in modifications or additions. Philips Semiconductors does not give any representations or warranties as to the accuracy or completeness of information included herein and shall have no liability for the consequences of use of such information.

Short data sheet — A short data sheet is an extract from a full data sheet with the same product type number(s) and title. A short data sheet is intended for quick reference only and should not be relied upon to contain detailed and full information. For detailed and full information see the relevant full data sheet, which is available on request via the local Philips Semiconductors sales office. In case of any inconsistency or conflict with the short data sheet, the full data sheet shall prevail.

11.3 Disclaimers

General — Information in this document is believed to be accurate and reliable. However, Philips Semiconductors does not give any representations or warranties, expressed or implied, as to the accuracy or completeness of such information and shall have no liability for the consequences of use of such information.

Right to make changes — Philips Semiconductors reserves the right to make changes to information published in this document, including without limitation specifications and product descriptions, at any time and without notice. This document supersedes and replaces all information supplied prior to the publication hereof.

Suitability for use — Philips Semiconductors products are not designed, authorized or warranted to be suitable for use in medical, military, aircraft, space or life support equipment, nor in applications where failure or

malfunction of a Philips Semiconductors product can reasonably be expected to result in personal injury, death or severe property or environmental damage. Philips Semiconductors accepts no liability for inclusion and/or use of Philips Semiconductors products in such equipment or applications and therefore such inclusion and/or use is for the customer's own risk.

Applications — Applications that are described herein for any of these products are for illustrative purposes only. Philips Semiconductors makes no representation or warranty that such applications will be suitable for the specified use without further testing or modification.

Limiting values — Stress above one or more limiting values (as defined in the Absolute Maximum Ratings System of IEC 60134) may cause permanent damage to the device. Limiting values are stress ratings only and operation of the device at these or any other conditions above those given in the Characteristics sections of this document is not implied. Exposure to limiting values for extended periods may affect device reliability.

Terms and conditions of sale — Philips Semiconductors products are sold subject to the general terms and conditions of commercial sale, as published at <http://www.semiconductors.philips.com/profile/terms>, including those pertaining to warranty, intellectual property rights infringement and limitation of liability, unless explicitly otherwise agreed to in writing by Philips Semiconductors. In case of any inconsistency or conflict between information in this document and such terms and conditions, the latter will prevail.

No offer to sell or license — Nothing in this document may be interpreted or construed as an offer to sell products that is open for acceptance or the grant, conveyance or implication of any license under any copyrights, patents or other industrial or intellectual property rights.

11.4 Trademarks

Notice: All referenced brands, product names, service names and trademarks are the property of their respective owners.

12. Contact information

For additional information, please visit: <http://www.semiconductors.philips.com>

For sales office addresses, send an email to: sales.addresses@www.semiconductors.philips.com

13. Contents

1	Product profile	1
1.1	General description	1
1.2	Features	1
1.3	Applications	1
1.4	Quick reference data	1
2	Pinning information	2
3	Ordering information	3
4	Marking	3
5	Limiting values	4
6	Thermal characteristics	4
7	Characteristics	5
8	Package outline	6
9	Packing information	7
10	Revision history	8
11	Legal information	9
11.1	Data sheet status	9
11.2	Definitions	9
11.3	Disclaimers	9
11.4	Trademarks	9
12	Contact information	9
13	Contents	10

Please be aware that important notices concerning this document and the product(s) described herein, have been included in section 'Legal information'.



© Koninklijke Philips Electronics N.V. 2006. All rights reserved.

For more information, please visit: <http://www.semiconductors.philips.com>.

For sales office addresses, email to: sales.addresses@www.semiconductors.philips.com.

Date of release: 10 March 2006

Document identifier: PDTC123T_SER_1