

M52003AFP

PAL VIDEO CHROMA INTERFACE

DESCRIPTION

The M52003AFP is a semiconductor integrated circuit with video signal processing functions ideal for PAL color LCD TV. From luminance and color signals, it produces RGB signals suitable for driving an LCD panel.

FEATURES

- Two power supply lines, for large output amplitude
- Low power dissipation (240mW)
- On-screen signal input SW applicable to external analog input signals
- Video AGC to increase contrast
- γ correction circuit to correct nonlinearity of luminance characteristics with respect to applied voltage — a characteristic peculiar to LCD panels
- Multiple control functions such as color contrast control, picture quality control, luminance control, driver circuit, bias control, γ control, and common electrode polarity selector.
- Combinable with SECAM chroma IC (M51404AFP) to make PAL/SECAM system

APPLICATION

Active matrix color LCD TV

RECOMMENDED OPERATING CONDITION

Rated supply voltage $V_{CC} = +4.5 \pm 0.5V$
 $V_{EE} = -7.5 \pm 0.5V$
 Video input $0.5V_{P-P}$
 Chroma input $100mV_{P-P}$ (burst level)
 External RGB input $0.8V_{P-P}$

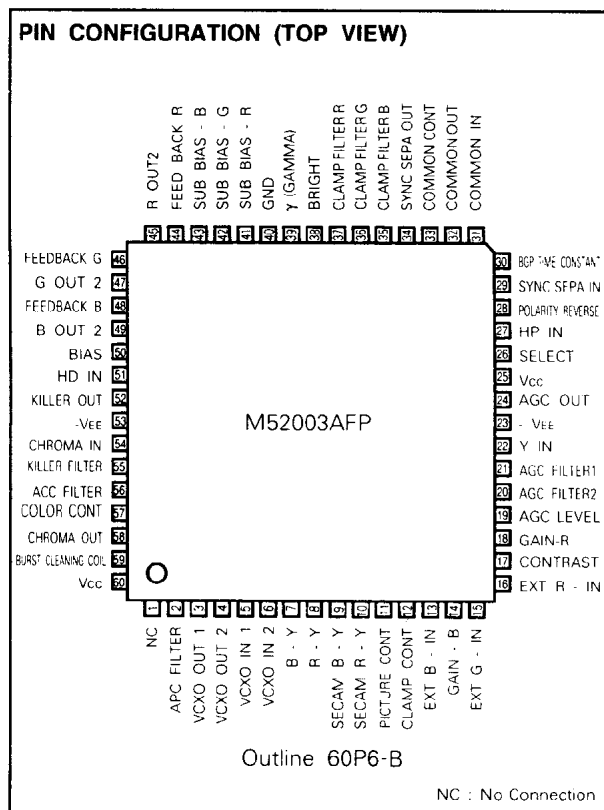

M52003AFP

PAL VIDEO CHROMA INTERFACE

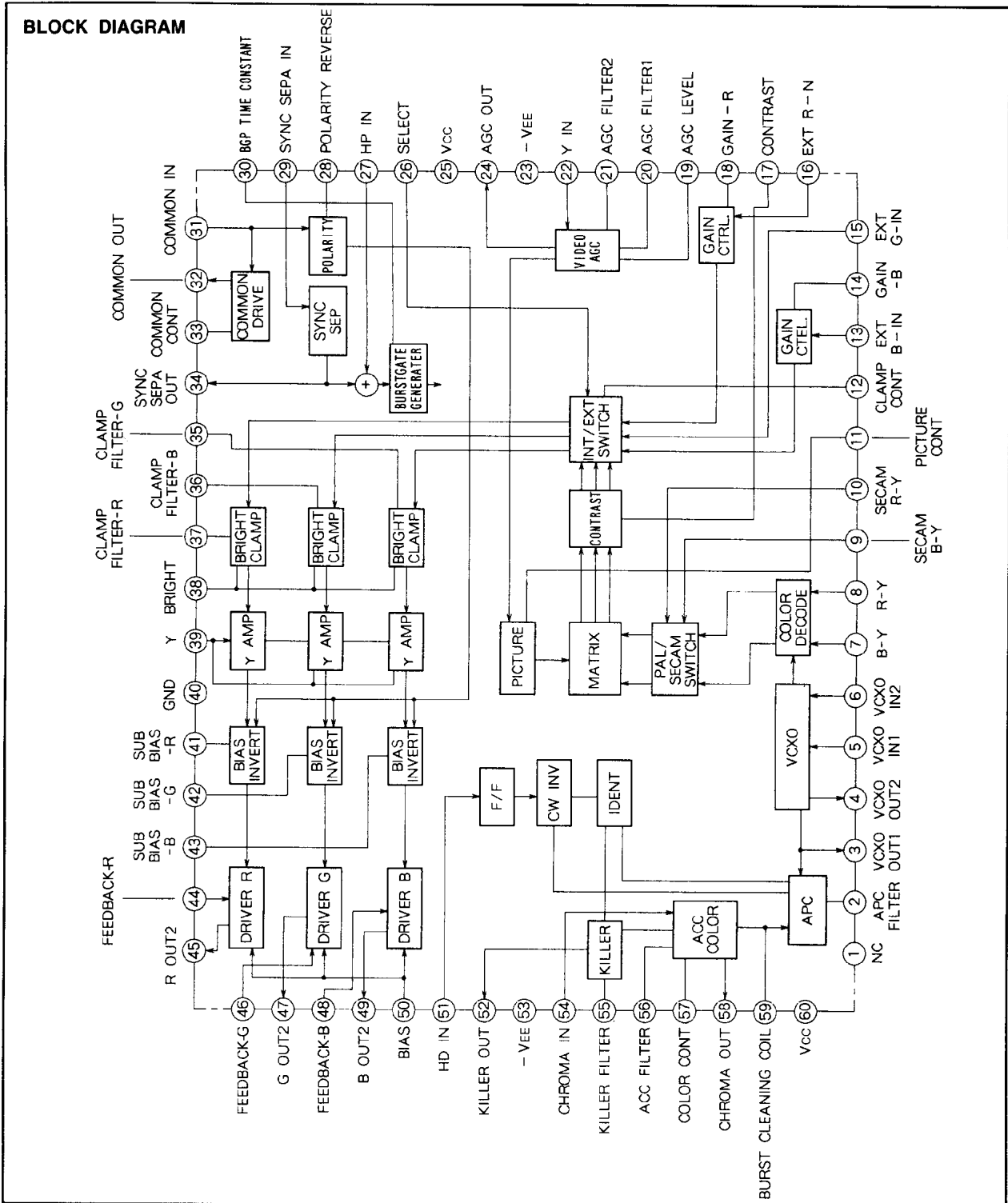

M52003AFP

PAL VIDEO CHROMA INTERFACE

ABSOLUTE MAXIMUM RATINGS

Symbol	Parameter	Ratings	Unit
V _{cc}	Supply voltage	13	V
P _d	Power dissipation	910	mW
K _θ	Thermal derating	9.1	mW/°C
T _{opr}	Operating temperature	- 20~75	°C
T _{stg}	Storage temperature	- 40~125	°C

ELECTRICAL CHARACTERISTICS (T_a = 25°C, unless otherwise noted)

Symbol	Parameter	Test conditions	Test point	Remarks	Limits			Unit
					Min.	Typ.	Max.	
I _{cc}	Circuit current (+)	No input. ②, ③ = 4.5V	②, ③		30.0	40.0	50.0	mA
I _{EE}	Circuit current (-)	②, ③ = - 7.5V	②, ③		- 11.5	- 8.5	- 5.5	mA
SSOL	Sync separation L voltage	I ₃₄ = 1mA	③			0.5	1.0	V
SSOH	Sync separation H voltage		③		4.0	4.4		V
COL	Common driver output voltage	I ₃₂ = 3mA, ① = 4V. Input to pin ③ only.	②			- 6.5	- 5.5	V
COH	Common driver output voltage	I ₃₂ = - 3mA, ① = 0V. Input to pin ③ only.	②		2.0	3.0	4.0	V
ROL	R output voltage L	I ₄₅ = 2mA, ① = 4V. Input to pin ③ only.	④			- 2.0	0	V
ROH	R output voltage H	I ₄₅ = - 2mA, ① = 0V. Input to pin ③ only.	④		2.0	3.0	4.0	V
GOL	G output voltage L	I ₄₇ = 2mA, ① = 4V. Input to pin ③ only.	④			- 2.0	0	V
GOH	G output voltage H	I ₄₇ = - 2mA, ① = 0V. Input to pin ③ only.	④		2.0	3.0	4.0	V
BOL	B output voltage L	I ₄₉ = 2mA, ① = 4V. Input to pin ③ only.	④			- 2.0	0	V
BOH	B output voltage H	I ₄₉ = - 2mA, ① = 0V. Input to pin ③ only.	④		2.0	3.0	4.0	V
SSO1	Sync separation output 1	② = 1V _{P-P} video	③		3.5	4.3	4.5	V _{P-P}
SSO2	Sync separation output 2	② = 0.3V _{P-P} video	③		3.5	4.3	4.5	V _{P-P}
SSO3	Sync separation output 3	② = 2V _{P-P} video	③		3.5	4.3	4.5	V _{P-P}
HP1	HP input	② = HP input (4 μS, 3V _{P-P})	③			0		V _{P-P}
SSD1	Sync separation output delay time 1	② = 1V _{P-P} video, rise time	③		0.1	0.6	1.2	μS
SSD2	Sync separation output delay time 2	② = 1V _{P-P} video, fall time	③		0.1	0.6	1.2	μS
AGL1	AGC level 1	② = 0.5V _{P-P} video, = = 1.0V	④		0.5	1.0	1.5	V _{P-P}
AGL2	AGC level 2	② = 0.5V _{P-P} video, = = 3.5V	④		2.0	4.0	6.0	V _{P-P}
AGL3	AGC level 3	② = 0.5V _{P-P} video, = = 3.0V	④		0.5	1.5	2.5	V _{P-P}
AGL4	AGC level 4	② = 0.3V _{P-P} video, = = 3.0V	④		0.5	1.0	1.5	V _{P-P}
AGL5	AGC level 5	② = 0.7V _{P-P} video, = = 3.0V	④		1.0	2.0	3.0	V _{P-P}
AGM	AGC maximum gain	② = 0.2V _{P-P} video, ③ = 4.5V	④		5.0	6.0	10.0	V _{P-P}
AGO _H	AGC output voltage H	② = 0.2V _{P-P} video, ③ = 4.0V	④		2.5	3.5	4.5	V
AGO _L	AGC output voltage L	② = 0.7V _{P-P} video, ③ = 1.0V	④		-	0.3	1.0	V
AGR	AGC level R	② = 0.5V _{P-P} video, ③ = 3.0V	④		0.5	1.5	2.5	V _{P-P}
AGB	AGC level B	② = 0.5V _{P-P} video, ③ = 3.0V	④		0.5	1.5	2.5	V _{P-P}
AGGR	GAIN control R	② = 0.5V _{P-P} video, ③ = 3.0V, = = 2V	④		1.5	3.0	4.5	V _{P-P}
AGGB	GAIN control B	② = 0.5V _{P-P} video, ③ = 3.0V, ④ = 2V	④		1.5	3.0	4.5	V _{P-P}
P _{ct}	Picture quality, center	② = 0.3V _{P-P} video, 200k/2MHz, ① = 2.5V	④		- 7.0	- 3.0	0	dB
P _{max1}	Picture quality, maximum 1	② = 0.3V _{P-P} video, 200k/1MHz, ① = 4.0V	④		- 5.0	- 2.0	0	dB
P _{max2}	Picture quality, maximum 2	② = 0.3V _{P-P} video, 200k/2MHz, ① = 4.0V	④		- 10.0	- 5.0	0	dB
P _{max3}	Picture quality, maximum 3	② = 0.3V _{P-P} video, 200k/500MHz, ① = 4.0V	④		- 2.0	- 0.6	0	dB
P _{min1}	Picture quality, minimum 1	② = 0.3V _{P-P} video, 200k/1MHz, ① = 1.0V	④			2.0	5.0	dB
P _{min2}	Picture quality, minimum 2	② = 0.3V _{P-P} video, 200k/2MHz, ① = 1.0V	④			2.0	5.0	dB
P _{in1}	Picture quality change 1	② = 0.3V _{P-P} video, 2MHz, ① = 0/2.5V	④		2.5	6.5	10.5	dB
P _{in2}	Picture quality change 2	② = 0.3V _{P-P} video, 2MHz, ① = 2.5/4.5V	④		0	2.5	6.0	dB
P _{in3}	Picture quality change 3	② = 0.3V _{P-P} video, 1MHz, ① = 0/2.5V	④		0.5	4.5	8.5	dB
P _{in4}	Picture quality change 4	② = 0.3V _{P-P} video, 1MHz, ① = 2.5/4.5V	④		0	1.0	2.0	dB
PIV	Inversion frequency characteristics	② = 0.3V _{P-P} video, 2MHz, ① = 4.0V	④	③ = 1/4V	- 4.0	0	+ 4.0	dB
ACC1	ACC characteristics 1	④ = 0dB chroma, ⑤ = 1.7V	④		5.0	8.0	11.0	V _{P-P}
ACC2	ACC characteristics 2	④ = + 6dB chroma, ⑤ = - 1.7V	④	Ratio to measurement in C1		0.1	2.0	dB
ACC3	ACC characteristics 3	④ = - 20dB chroma, ⑤ = 1.7V	④	Ratio to measurement in C1	- 7.0	- 5.5		dB
CSAT1	Color saturation characteristics 1	④ = 0dB chroma, ⑤ = 3.0V	④	Ratio to measurement in C1		0.2	2.0	dB
CSAT2	Color saturation characteristics 2	④ = 0dB chroma, ⑤ = 1.4V	④	Ratio to measurement in C1	- 8.5	- 4.5	- 0.5	dB

M52003AFP

PAL VIDEO CHROMA INTERFACE

ELECTRICAL CHARACTERISTICS (cont.)

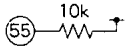
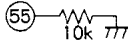
Symbol	Parameter	Test conditions	Test point	Remarks	Limits			Unit
					Min.	Typ.	Max.	
CSAT3	Color saturation characteristics 3	⑤④ = 0dB chroma, ⑤ = 1.0V	②④	Ratio to measurement in C1	-40.0	-30.0		dB
CCTR1	Color control characteristics 1	⑤④ = 0dB chroma, ⑤ = 4.5V	"		0	0.2	2.5	V _{P-P}
CCTR2	Color control characteristics 2	⑤④ = 0dB chroma, ⑤ = 3.0V	"	Ratio to measurement in C7	-10.0	-5.5	0	dB
CCTR3	Color control characteristics 3	⑤④ = 0dB chroma, ⑤ = 1.5V	⑤⑧	Ratio to measurement in C7	-35.0	-25.0		dB
CKLR	Killer operating input	⑤④ = 0dB chroma, ⑤ = 1.7V	⑤④	Input value when output at pin 52 is H		-40	-30	dB
DB	B demodulator sensitivity	⑤④ = 0dB chroma, ⑤ = 1.7V	④⑨		5.0	8.0	11.0	V _{P-P}
DEM1	Demodulated output amplitude ratio 1	⑤④ = 0dB chroma, ⑤ = 1.7V	④⑤	Ratio to measurement in C11	0.4	0.6	0.8	V _{P-P}
DEM2	Demodulated output amplitude ratio 2	⑤④ = 0dB chroma, ⑤ = 1.7V	④⑦		0.2	0.3	0.4	V _{P-P}
Δf _{VCO}	VCO free run frequency	⑤④ = No input, ⑤ = 1.7V	④	Difference from 443619Hz	-1000	0	+1000	Hz
Δf _{APC1}	APC pull-in range 1	⑤④ = 0dB chroma with variable frequency	⑤②		+200	+500	+1000	Hz
Δf _{APC2}	APC pull-in range 2	⑤④ = 0dB chroma with variable frequency	⑤②		-1000	-500	-200	Hz
DL	Demodulated output carrier leak	⑤④ = 0dB chroma	④⑨	8.9MHz component		50	200	mV _{P-P}
PRB	Demodulated phase angle 1	⑤④ = 0dB chroma	④⑤, ④⑨		70	110	150	deg.
PGB	Demodulated phase angle 2	⑤④ = 0dB chroma	④⑦, ④⑨		210	250	290	deg.
V _{KL RH}	KILLER OUT pin voltage H	⑤④ = No input 	⑤②		3.0	3.5	4.0	V
V _{KL RL}	KILLER OUT pin voltage L	⑤④ = No input 	⑤②			0.2	0.5	V
SDB	SECAM demodulator sensitivity	⑨, ⑩=100kHz, 0.3V _{P-P} sine wave, ⑤=0V	④⑨	⑧ is connected to ②② via 10kΩ	5.0	7.5	10.0	V _{P-P}
SDEM1	SECAM demodulated output amplitude 1	⑨, ⑩=100kHz, 0.3V _{P-P} sine wave, ⑤=0V	④⑤	Ratio to measurement in SDb	0.4	0.6	0.8	-
SDEM2	SECAM demodulated output amplitude 2	⑨, ⑩=100kHz, 0.3V _{P-P} sine wave, ⑤=0V	④⑦	Ratio to measurement in SDb	0.3	0.4	0.5	-
VAPC	APC FILTER voltage	⑤④ = 0dB chroma, ⑤ = 1.7V	②		2.9	3.2	3.3	V

M52003AFP

PAL VIDEO CHROMA INTERFACE

ELECTRICAL CHARACTERISTICS (cont.)

Symbol	Parameter	Test conditions	Test point	Remarks	Limits			Unit
					Min.	Typ.	Max.	
R OUTPUT SECTION								
SBR	Sub bias change	㉒ = 0.5V _{P-P} video, ㉑ = 0/3V	㉕		3.5	4.5	5.5	V
INR-1	Inverted output 1	㉒ = 0.5V _{P-P} video, ㉑ = 1/4V, ㉑ = 0V	㉕		2.0	3.0	4.0	V _{P-P}
INR-2	Inverted output 2	㉒ = 0.5V _{P-P} video, ㉑ = 1/4V, ㉑ = 3V	㉕		7.0	10.0	12.0	V _{P-P}
INR-3	Inverted output 3	㉒ = 0.5V _{P-P} video, ㉑ = 1/4V, ㉑ = 3V	㉕		7.0	10.0	12.0	V _{P-P}
YR-1	Y characteristics 1	㉓ = 0.1V _{P-P} video with no sync signal, ㉓ = 3.5/4.5V	㉕		2.0	3.0	4.0	-
YR-2	Y characteristics 2	㉓ = 0.4V _{P-P} video with no sync signal, ㉓ = 3.5/4.5V	㉕		0.8	1.4	2.0	-
YR-3	Y characteristics 3	㉓ = 0.6V _{P-P} video with no sync signal, ㉓ = 3.5/4.5V	㉕		0.6	1.2	1.8	-
YR-4	Y characteristics 4	㉓ = 0.8V _{P-P} video with no sync signal, ㉓ = 3.5/4.5V	㉕		0.6	1.2	1.8	-
MOR	Maximum output difference	㉓ = 0.9V _{P-P} video with no sync signal, ㉑ = 1/4V	㉕		0.4	0.9	1.4	-
VCR	Center voltage γ	㉓ = 0.2V _{P-P} video with no sync signal, ㉑ = 1/4V	㉕		-1.6	-1.7	-1.95	V
GCR	Gain control	㉓ = 0.6V _{P-P} video with no sync signal, ㉑ = 3.8/3.2V	㉕		0.4	0.9	1.4	-
VOR	Output amplitude	㉒ = 0.5V _{P-P} video, ㉑ = 0V, ㉑ = 3.55V	㉕		6.0	8.0	-	V _{P-P}
CLR	EXT clamping level	㉒ = 0.41V _{P-P} video, ㉑ = 0.75V, ㉑ = 3.55V	㉖	㉖ = L/H	-	-0.1	0.6	V
G OUTPUT SECTION								
SBG	Sub bias change	㉒ = 0.5V _{P-P} video, ㉑ = 0/3V	㉗		3.5	4.5	5.5	V
ING-1	Inverted output 1	㉒ = 0.5V _{P-P} video, ㉑ = 1/4V, ㉑ = 0V	㉗		2.0	3.0	4.0	V _{P-P}
ING-2	Inverted output 2	㉒ = 0.5V _{P-P} video, ㉑ = 1/4V, ㉑ = 3V	㉗		7.0	10.0	12.0	V _{P-P}
ING-3	Inverted output 3	㉒ = 0.5V _{P-P} video, ㉑ = 1/4V, ㉑ = 3V	㉗		7.0	10.0	12.0	V _{P-P}
YG-1	Y characteristics 1	㉓ = 0.1V _{P-P} video with no sync signal, ㉓ = 3.5/4.5V	㉗		2.0	3.0	4.0	-
YG-2	Y characteristics 2	㉓ = 0.4V _{P-P} video with no sync signal, ㉓ = 3.5/4.5V	㉗		0.8	1.4	2.0	-
YG-3	Y characteristics 3	㉓ = 0.6V _{P-P} video with no sync signal, ㉓ = 3.5/4.5V	㉗		0.6	1.2	1.8	-
YG-4	Y characteristics 4	㉓ = 0.8V _{P-P} video with no sync signal, ㉓ = 3.5/4.5V	㉗		0.6	1.2	1.8	-
MOG	Maximum output difference	㉓ = 0.9V _{P-P} video with no sync signal, ㉑ = 1/4V	㉗		0.4	0.9	1.4	-
VCG	Center voltage	㉓ = 0.2V _{P-P} video with no sync signal, ㉑ = 1/4V	㉗		-1.6	-1.7	-1.95	V
VOG	Output amplitude	㉒ = 0.5V _{P-P} video, ㉑ = 0V, ㉑ = 3.55V	㉗		6.0	8.0	-	V _{P-P}
CLG	EXT clamping level	㉒ = 0.41V _{P-P} video, ㉑ = 1.75V, ㉑ = 3.55V	㉘	㉘ = L/H	-	-0.1	0.6	V
B OUTPUT SECTION								
SBB	Sub bias change	㉒ = 0.5V _{P-P} video, ㉑ = 0/3V	㉙		3.5	4.5	5.5	V
INB-1	Inverted output 1	㉒ = 0.5V _{P-P} video, ㉑ = 1/4V, ㉑ = 0V	㉙		2.0	3.0	4.0	V _{P-P}
INB-2	Inverted output 2	㉒ = 0.5V _{P-P} video, ㉑ = 1/4V, ㉑ = 3V	㉙		7.0	10.0	12.0	V _{P-P}
INB-3	Inverted output 3	㉒ = 0.5V _{P-P} video, ㉑ = 1/4V, ㉑ = 3V	㉙		7.0	10.0	12.0	V _{P-P}
YB-1	Y characteristics 1	㉓ = 0.1V _{P-P} video with no sync signal, ㉓ = 3.5/4.5V	㉙		2.0	3.0	4.0	-
YB-2	Y characteristics 2	㉓ = 0.4V _{P-P} video with no sync signal, ㉓ = 3.5/4.5V	㉙		0.8	1.4	2.0	-
YB-3	Y characteristics 3	㉓ = 0.6V _{P-P} video with no sync signal, ㉓ = 3.5/4.5V	㉙		0.6	1.2	1.8	-
YB-4	Y characteristics 4	㉓ = 0.8V _{P-P} video with no sync signal, ㉓ = 3.5/4.5V	㉙		0.6	1.2	1.8	-
MOB	Maximum output difference	㉓ = 0.9V _{P-P} video with no sync signal, ㉑ = 1/4V	㉙		0.4	0.9	1.4	-
VCB	Center voltage	㉓ = 0.2V _{P-P} video with no sync signal, ㉑ = 1/4V	㉙		-1.6	-1.7	-1.95	V
GCB	Gain control	㉓ = 0.6V _{P-P} video with no sync signal, ㉑ = 3.8/3.2V	㉙		0.4	0.9	1.4	-
VOB	Output amplitude	㉒ = 0.5V _{P-P} video, ㉑ = 0V, ㉑ = 3.55V	㉙		6.0	8.0	-	V _{P-P}
CLB	EXT clamping level	㉒ = 0.41V _{P-P} video, ㉑ = 1.75V, ㉑ = 3.55V	㉚	㉚ = L/H	-	-0.1	0.6	V

M52003AFP

PAL VIDEO CHROMA INTERFACE

ELECTRICAL CHARACTERISTIC TEST CONDITIONS

Symbol	Test point														Unit
	11	12	14	17	18	19	31	33	38	39	41	42	43	57	
I _{CC}	4.0	1.3	3.5	2.0	3.5	3.5	—	4.0	1.0	4.5	1.7	1.7	1.7	1.7	V
I _{EE}	4.0	1.3	3.5	2.0	3.5	3.5	—	4.0	1.0	4.5	1.7	1.7	1.7	1.7	V
SS _{OL}	4.0	1.3	3.5	2.0	3.5	3.5	—	4.0	1.0	4.5	1.7	1.7	1.7	1.7	V
SS _{OH}	4.0	1.3	3.5	2.0	3.5	3.5	—	4.0	1.0	4.5	1.7	1.7	1.7	1.7	V
CO _L	4.0	1.3	3.5	2.0	3.5	3.5	4.0	4.0	1.0	4.5	1.7	1.7	1.7	1.7	V
CO _H	4.0	1.3	3.5	2.0	3.5	3.5	1.0	4.0	1.0	4.5	1.7	1.7	1.7	1.7	V
RO _L	4.0	1.3	3.5	2.0	3.5	3.5	4.0	4.0	1.0	4.5	1.7	1.7	1.7	1.7	V
RO _H	4.0	1.3	3.5	2.0	3.5	3.5	1.0	4.0	1.0	4.5	1.7	1.7	1.7	1.7	V
GO _L	4.0	1.3	3.5	2.0	3.5	3.5	4.0	4.0	1.0	4.5	1.7	1.7	1.7	1.7	V
GO _H	4.0	1.3	3.5	2.0	3.5	3.5	1.0	4.0	1.0	4.5	1.7	1.7	1.7	1.7	V
BO _L	4.0	1.3	3.5	2.0	3.5	3.5	4.0	4.0	1.0	4.5	1.7	1.7	1.7	1.7	V
BO _H	4.0	1.3	3.5	2.0	3.5	3.5	1.0	4.0	1.0	4.5	1.7	1.7	1.7	1.7	V
SSO1	4.0	1.3	3.5	2.0	3.5	3.5	—	4.0	1.0	4.5	1.7	1.7	1.7	1.7	V
SSO2	4.0	1.3	3.5	2.0	3.5	3.5	—	4.0	1.0	4.5	1.7	1.7	1.7	1.7	V
SSO3	4.0	1.3	3.5	2.0	3.5	3.5	—	4.0	1.0	4.5	1.7	1.7	1.7	1.7	V
HP1	4.0	1.3	3.5	2.0	3.5	3.5	—	4.0	1.0	4.5	1.7	1.7	1.7	1.7	V
SSD1	4.0	1.3	3.5	2.0	3.5	3.5	—	4.0	1.0	4.5	1.7	1.7	1.7	1.7	V
SSD2	4.0	1.3	3.5	2.0	3.5	3.5	—	4.0	1.0	4.5	1.7	1.7	1.7	1.7	V
AGL1	4.0	1.3	3.5	2.0	3.5	1.0	—	4.0	1.0	4.5	1.7	1.7	1.7	1.7	V
AGL2	4.0	1.3	3.5	2.0	3.5	3.5	—	4.0	1.0	4.5	1.7	1.7	1.7	1.7	V
AGL3	4.0	1.3	3.5	2.0	3.5	3.0	—	4.0	1.0	4.5	1.7	1.7	1.7	1.7	V
AGL4	4.0	1.3	3.5	2.0	3.5	3.0	—	4.0	1.0	4.5	1.7	1.7	1.7	1.7	V
AGL5	4.0	1.3	3.5	2.0	3.5	3.0	—	4.0	1.0	4.5	1.7	1.7	1.7	1.7	V
AGM	4.0	1.3	3.5	2.0	3.5	4.5	—	4.0	1.0	4.5	1.7	1.7	1.7	1.7	V
AG _{OH}	4.0	1.3	3.5	2.0	3.5	4.0	—	4.0	1.0	4.5	1.7	1.7	1.7	1.7	V
AG _{OL}	4.0	1.3	3.5	2.0	3.5	1.0	—	4.0	1.0	4.5	1.7	1.7	1.7	1.7	V
AGR	4.0	1.3	3.5	2.0	3.5	3.0	—	4.0	1.0	4.5	1.7	1.7	1.7	1.7	V
AGB	4.0	1.3	3.5	2.0	3.5	3.0	—	4.0	1.0	4.5	1.7	1.7	1.7	1.7	V
AGGR	4.0	1.3	3.5	2.0	2.0	3.0	—	4.0	1.0	4.5	1.7	1.7	1.7	1.7	V
AGGB	4.0	1.3	2.0	2.0	3.5	3.0	—	4.0	1.0	4.5	1.7	1.7	1.7	1.7	V
P _{ct}	2.5	1.3	3.5	2.0	3.5	3.0	—	4.0	1.0	4.5	1.7	1.7	1.7	1.7	V
P _{max1}	4.0	1.3	3.5	2.0	3.5	3.0	—	4.0	1.0	4.5	1.7	1.7	1.7	1.7	V
P _{max2}	4.0	1.3	3.5	2.0	3.5	3.0	—	4.0	1.0	4.5	1.7	1.7	1.7	1.7	V
P _{max3}	4.0	1.3	3.5	2.0	3.5	3.0	—	4.0	1.0	4.5	1.7	1.7	1.7	1.7	V
P _{min1}	1.0	1.3	3.5	2.0	3.5	3.0	—	4.0	1.0	4.5	1.7	1.7	1.7	1.7	V
P _{min2}	1.0	1.3	3.5	2.0	3.5	3.0	—	4.0	1.0	4.5	1.7	1.7	1.7	1.7	V
P _{in1}	0/2.5	1.3	3.5	2.0	3.5	3.0	—	4.0	1.0	4.5	1.7	1.7	1.7	1.7	V
P _{in2}	2.5/4.5	1.3	3.5	2.0	3.5	3.0	—	4.0	1.0	4.5	1.7	1.7	1.7	1.7	V
P _{in3}	0/2.5	1.3	3.5	2.0	3.5	3.0	—	4.0	1.0	4.5	1.7	1.7	1.7	1.7	V
P _{in4}	2.5/4.5	1.3	3.5	2.0	3.5	3.0	—	4.0	1.0	4.5	1.7	1.7	1.7	1.7	V
P _{lv}	4.0	1.3	3.5	2.0	3.5	3.0	1.0/4.0	4.0	1.0	4.5	1.7	1.7	1.7	1.7	V
ACC1	4.0	1.3	3.5	2.0	3.5	3.5	—	4.0	1.0	4.5	1.7	1.7	1.7	1.7	V
ACC2	4.0	1.3	3.5	2.0	3.5	3.5	—	4.0	1.0	4.5	1.7	1.7	1.7	1.7	V
ACC3	4.0	1.3	3.5	2.0	3.5	3.5	—	4.0	1.0	4.5	1.7	1.7	1.7	1.7	V
CSAT1	4.0	1.3	3.5	2.0	3.5	3.5	—	4.0	1.0	4.5	1.7	1.7	1.7	3.0	V
CSAT2	4.0	1.3	3.5	2.0	3.5	3.5	—	4.0	1.0	4.5	1.7	1.7	1.7	1.4	V
CSAT3	4.0	1.3	3.5	2.0	2.0	3.5	—	4.0	1.0	4.5	1.7	1.7	1.7	1.0	V
CCTR1	4.0	1.3	3.5	2.0	3.5	3.5	—	4.0	1.0	4.5	1.7	1.7	1.7	4.5	V
CCTR2	4.0	1.3	3.5	2.0	3.5	3.5	—	4.0	1.0	4.5	1.7	1.7	1.7	3.0	V
CCTR3	4.0	1.3	3.5	2.0	3.5	3.5	—	4.0	1.0	4.5	1.7	1.7	1.7	1.5	V
CKLR	4.0	1.3	3.5	2.0	3.5	3.5	—	4.0	1.0	4.5	1.7	1.7	1.7	1.7	V
D _B	4.0	1.3	3.5	2.0	3.5	3.5	—	4.0	1.0	4.5	1.7	1.7	1.7	1.7	V
DEM1	4.0	1.3	3.5	2.0	3.5	3.5	—	4.0	1.0	4.5	1.7	1.7	1.7	1.7	V
DEM2	4.0	1.3	3.5	2.0	3.5	3.5	—	4.0	1.0	4.5	1.7	1.7	1.7	1.7	V
Δ f _{VCO}	4.0	1.3	3.5	2.0	3.5	3.5	—	4.0	1.0	4.5	1.7	1.7	1.7	1.7	V

M52003AFP

PAL VIDEO CHROMA INTERFACE

ELECTRICAL CHARACTERISTIC TEST CONDITIONS (cont.)

Symbol	Test point														Unit
	11	12	14	17	18	19	31	33	38	39	41	42	43	57	
Δ fAPC1	4.0	1.3	3.5	2.0	3.5	3.5	-	4.0	1.0	4.5	1.7	1.7	1.7	1.7	V
Δ fAPC2	4.0	1.3	3.5	2.0	3.5	3.5	-	4.0	1.0	4.5	1.7	1.7	1.7	1.7	V
DL	4.0	1.3	3.5	2.0	3.5	3.5	-	4.0	1.0	4.5	1.7	1.7	1.7	1.7	V
PRB	4.0	1.3	3.5	2.0	3.5	3.5	-	4.0	1.0	4.5	1.7	1.7	1.7	1.7	V
PGB	4.0	1.3	3.5	2.0	3.5	3.5	-	4.0	1.0	4.5	1.7	1.7	1.7	1.7	V
VKLRH	4.0	1.3	3.5	2.0	3.5	3.5	-	4.0	1.0	4.5	1.7	1.7	1.7	1.7	V
VKLRH	4.0	1.3	3.5	2.0	3.5	3.5	-	4.0	1.0	4.5	1.7	1.7	1.7	1.7	V
SDB	4.0	1.3	3.5	2.0	3.5	3.5	-	4.0	1.0	4.5	1.7	1.7	1.7	0	V
SDEM1	4.0	1.3	3.5	2.0	3.5	3.5	-	4.0	1.0	4.5	1.7	1.7	1.7	0	V
SDEM2	4.0	1.3	3.5	2.0	3.5	3.5	-	4.0	1.0	4.5	1.7	1.7	1.7	0	V
VAPC	4.0	1.3	3.5	2.0	3.5	3.5	-	4.0	1.0	4.5	1.7	1.7	1.7	1.7	V
SBR	4.0	1.3	3.5	2.0	3.5	3.5	-	4.0	1.0	4.5	0/3.0	1.7	1.7	1.7	V
INR1	4.0	1.3	3.5	2.0	3.5	3.5	1.0/4.0	4.0	1.0	4.5	0	1.7	1.7	1.7	V
INR2	4.0	1.3	3.5	2.0	3.5	3.5	1.0/4.0	4.0	1.0	4.5	3.0	1.7	1.7	1.7	V
INR3	4.0	1.3	3.5	2.0	3.5	3.5	1.0/4.0	4.0	1.0	4.5	3.0	1.7	1.7	1.7	V
Y R1	4.0	1.3	3.5	2.0	3.5	3.5	-	4.0	1.0	3.5/4.5	1.7	1.7	1.7	1.7	V
Y R2	4.0	1.3	3.5	2.0	3.5	3.5	-	4.0	1.0	3.5/4.5	1.7	1.7	1.7	1.7	V
Y R3	4.0	1.3	3.5	2.0	3.5	3.5	-	4.0	1.0	3.5/4.5	1.7	1.7	1.7	1.7	V
Y R4	4.0	1.3	3.5	2.0	3.5	3.5	-	4.0	1.0	3.5/4.5	1.7	1.7	1.7	1.7	V
MOR	4.0	1.3	3.5	2.0	3.5	3.5	1.0/4.0	4.0	1.0	4.5	1.7	1.7	1.7	1.7	V
VCR	4.0	1.3	3.5	2.0	3.5	3.5	1.0/4.0	4.0	1.0	4.5	1.7	1.7	1.7	1.7	V
GCR	4.0	1.3	3.5	2.0	3.8/3.2	3.5	-	4.0	1.0	4.5	1.7	1.7	1.7	1.7	V
VOR	4.0	1.3	3.5	0	3.5	3.55	-	4.0	1.0	4.5	1.7	1.7	1.7	1.7	V
CLR	4.0	1.35	3.5	1.75	3.5	3.55	-	4.0	1.0	4.5	1.7	1.7	1.7	1.7	V
SBG	4.0	1.3	3.5	2.0	3.5	3.5	-	4.0	1.0	4.5	1.7	0/3.0	1.7	1.7	V
ING1	4.0	1.3	3.5	2.0	3.5	3.5	1.0/4.0	4.0	1.0	4.5	1.7	0	1.7	1.7	V
ING2	4.0	1.3	3.5	2.0	3.5	3.5	1.0/4.0	4.0	1.0	4.5	1.7	3.0	1.7	1.7	V
ING3	4.0	1.3	3.5	2.0	3.5	3.5	1.0/4.0	4.0	1.0	4.5	1.7	3.0	1.7	1.7	V
Y G1	4.0	1.3	3.5	2.0	3.5	3.5	-	4.0	1.0	3.5/4.5	1.7	1.7	1.7	1.7	V
Y G2	4.0	1.3	3.5	2.0	3.5	3.5	-	4.0	1.0	3.5/4.5	1.7	1.7	1.7	1.7	V
Y G3	4.0	1.3	3.5	2.0	3.5	3.5	-	4.0	1.0	3.5/4.5	1.7	1.7	1.7	1.7	V
Y G4	4.0	1.3	3.5	2.0	3.5	3.5	-	4.0	1.0	3.5/4.5	1.7	1.7	1.7	1.7	V
MOG	4.0	1.3	3.5	2.0	3.5	3.5	1.0/4.0	4.0	1.0	4.5	1.7	1.7	1.7	1.7	V
VCG	4.0	1.3	3.5	2.0	3.5	3.5	1.0/4.0	4.0	1.0	4.5	1.7	1.7	1.7	1.7	V
VOG	4.0	1.3	3.5	0	3.5	3.55	-	4.0	1.0	4.5	1.7	1.7	1.7	1.7	V
CLG	4.0	1.35	3.5	1.75	3.5	3.55	-	4.0	1.0	4.5	1.7	1.7	1.7	1.7	V
SBB	4.0	1.3	3.5	2.0	3.5	3.5	-	4.0	1.0	4.5	1.7	1.7	0/3.0	1.7	V
INB1	4.0	1.3	3.5	2.0	3.5	3.5	1.0/4.0	4.0	1.0	4.5	1.7	1.7	0	1.7	V
INB2	4.0	1.3	3.5	2.0	3.5	3.5	1.0/4.0	4.0	1.0	4.5	1.7	1.7	3.0	1.7	V
INB3	4.0	1.3	3.5	2.0	3.5	3.5	1.0/4.0	4.0	1.0	4.5	1.7	1.7	3.0	1.7	V
Y B1	4.0	1.3	3.5	2.0	3.5	3.5	-	4.0	1.0	3.5/4.5	1.7	1.7	1.7	1.7	V
Y B2	4.0	1.3	3.5	2.0	3.5	3.5	-	4.0	1.0	3.5/4.5	1.7	1.7	1.7	1.7	V
Y B3	4.0	1.3	3.5	2.0	3.5	3.5	-	4.0	1.0	3.5/4.5	1.7	1.7	1.7	1.7	V
Y B4	4.0	1.3	3.5	2.0	3.5	3.5	-	4.0	1.0	3.5/4.5	1.7	1.7	1.7	1.7	V
MOB	4.0	1.3	3.5	2.0	3.5	3.5	1.0/4.0	4.0	1.0	4.5	1.7	1.7	1.7	1.7	V
VCB	4.0	1.3	3.5	2.0	3.5	3.5	1.0/4.0	4.0	1.0	4.5	1.7	1.7	1.7	1.7	V
GCB	4.0	1.3	3.8/3.2	2.0	3.5	3.5	-	4.0	1.0	4.5	1.7	1.7	1.7	1.7	V
VOB	4.0	1.3	3.5	0	3.5	3.55	-	4.0	1.0	4.5	1.7	1.7	1.7	1.7	V
CLB	4.0	1.35	3.5	1.75	3.5	3.55	-	4.0	1.0	4.5	1.7	1.7	1.7	1.7	V

M52003AFP

PAL VIDEO CHROMA INTERFACE

INPUT SIGNALS

VIDEO SIGNAL

AMPLITUDE
MEASUREMENT

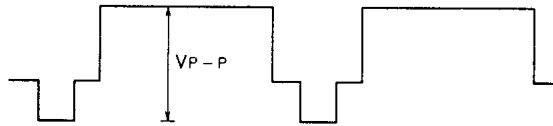

FREQUENCY
CHARACTERISTIC
MEASUREMENT

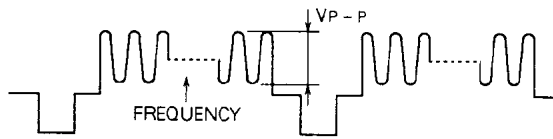

EXTERNAL RGB INPUT
PINS ⑬, ⑮ AND ⑯

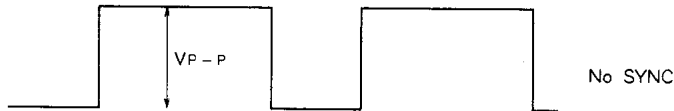

CHROMA SIGNAL

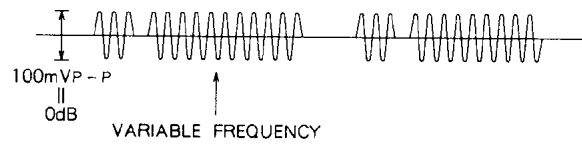

Unless otherwise specified, input video signal of 1VP-P to pin ② (SYNC SEPA IN).

TYPICAL CHARACTERISTICS

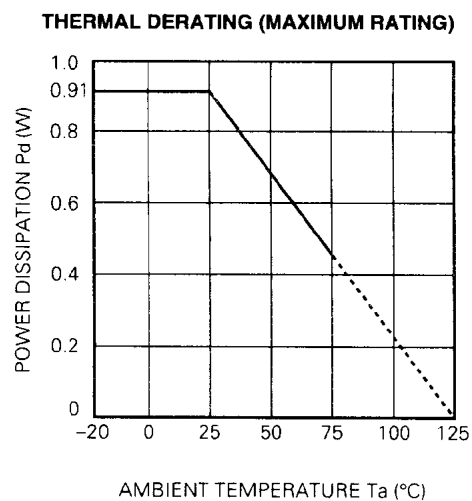

M52003AFP

PAL VIDEO CHROMA INTERFACE

DESCRIPTION OF PIN

Pin No.	Name	Peripheral circuit of pins
①	NC	—
②	APC FILTER	
③	VCXO OUT 1	
④	VCXO OUT 2	
⑤	VCXO IN 1	
⑥	VCXO IN 2	

M52003AFP

PAL VIDEO CHROMA INTERFACE

DESCRIPTION OF PIN (cont.)

Pin No.	Name	Peripheral circuit of pins
⑦	B - Y	
⑧	R - Y	
⑨	SECAM B - Y	
⑩	SECAM R - Y	
⑪	PICTURE CONT	
⑫	CLAMP CONT	
⑬	EXT "B" IN	
⑮	EXT "G" IN	
⑯	EXT "R" IN	

DESCRIPTION OF PIN (cont.)

Pin No.	Name	Peripheral circuit of pins
⑭	GAIN - B	
⑱	GAIN - R	
⑰	CONTRAST	
⑲	AGC LEVEL	
⑳	AGC FILTER 1	
㉔	AGC OUT	

DESCRIPTION OF PIN (cont.)

Pin No.	Name	Peripheral circuit of pins
22	Y - IN	
23	- V _{EE}	—
25	V _{cc}	—
26	SELECT SW "H" → EXT side "L" → TV side	
21	AGC FILTER 2	
27	HP IN	

DESCRIPTION OF PIN (cont.)

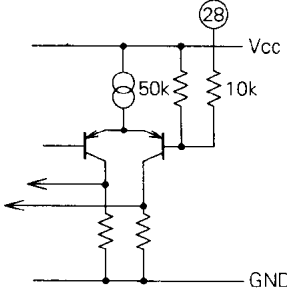
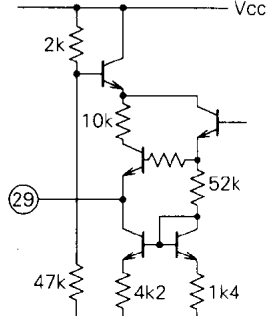
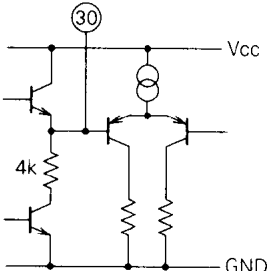
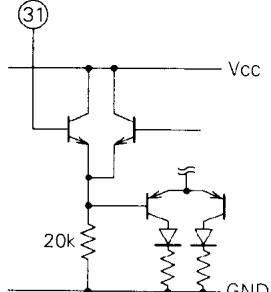
Pin No.	Name	Peripheral circuit of pins
28	POLARITY REVERSE	
29	SYNC SEPA IN	
30	BGP TIME CONSTANT	
31	COMMON IN	

DESCRIPTION OF PIN (cont.)

Pin No.	Name	Peripheral circuit of pins
32	COMMON OUT	
33	COMMON CONT	
34	SYNC SEPA OUT	<p>Open Collector</p>
35	CLAMP FILTER B	
36	CLAMP FILTER G	
37	CLAMP FILTER R	
38	BRIGHT CONT	

M52003AFP

PAL VIDEO CHROMA INTERFACE

DESCRIPTION OF PIN (cont.)

Pin No.	Name	Peripheral circuit of pins
39	Y control	
40	GND	—
41	SUB BIAS - R CONT	
42	SUB BIAS - G CONT	
43	SUB BIAS - B CONT	
44	FEEDBACK - R	
46	FEEDBACK - G	
48	FEEDBACK - B	
50	BIAS	
45	R - OUT	
47	G - OUT	
49	B - OUT	

DESCRIPTION OF PIN (cont.)

Pin No.	Name	Peripheral circuit of pins
⑤1	HD IN	
⑤2	killer OUT	
⑤3	- V _{EE}	—
⑤4	CHROMA IN	
⑤5	KILLER FILTER	

DESCRIPTION OF PIN (cont.)

Pin No.	Name	Peripheral circuit of pins
56	ACC FILTER	
57	COLOR CONT	
58	CHROMA OUT	
59	BURST CLEANING COIL	
60	V _{cc}	

M52003AFP

PAL VIDEO CHROMA INTERFACE

DESCRIPTION OF PIN (Values in () are standard settings : other values are median for standard operation.)

Pin No.	Name	Function	DC voltage (V)
①	NC	Open	
②	APC FILTER	Used to determine APC time constant of VCXO.	3.2
③	VCXO OUT 1	Output pin for VCXO oscillator	2.5
④	VCXO OUT 2 (VCXO monitor)	Output pin for monitor signal of VCXO oscillator. Signal is output through open emitter. Connect pin, when not used, to Vcc.	
⑤	VCXO IN 1	Feedback input pin for VCXO oscillator	3.8
⑥	VCXO IN 2	Signal input at pin ⑤ is phase-delayed and input to this pin.	3.8
⑦	B-Y (Color decoder input)	Input pin for chroma demodulator of B-Y signal	2.6
⑧	R-Y (Color decoder input)	Input pin for chroma demodulator of R-Y signal	2.6
⑨	SECAM B-Y (SECAM chroma input)	Input pin for SECAM B-Y chroma decoder output. Upon color killer activation, the internal switch is operated to select the SECAM signal.	2.6
⑩	SECAM R-Y (SECAM chroma input)	Input pin for SECAM R-Y chroma decoder output	2.6
⑪	PICTURE CONT	Used to control picture quality. Picture becomes sharper when voltage is decreased, softer when increased.	($\approx 1.5V_{DC}$)
⑫	CLAMP CONT (Clamping voltage control)	Used to conform internal signal clamping voltage level to that of external RGB signal.	($\approx 1.3V_{DC}$)
⑬	EXT B-IN	Input pin for external B signal. Standard input is 0.8V _{p-p} .	2.8
⑭	GAIN-B	Used to control B signal gain to adjust white balance. Standard voltage is 3.5V. Gain drops as voltage increases.	($\approx 3.5V_{DC}$)
⑮	EXT G-IN	Input pin for external G signal.	2.8
⑯	EXT R-IN	Input pin for external R signal.	2.8
⑰	CONTRAST	Used to control internal signal contrast. Contrast decreases when voltage is increased, increases when voltage is decreased.	($\approx 2.0V_{DC}$)
⑱	GAIN-R	Used to control R signal gain to adjust white balance.	($\approx 3.5V_{DC}$)
⑲	AGC LEVEL	Used to set AGC operating point.	($\approx 3.5V_{DC}$)
⑳	AGC FILTER 1	Terminal pin for AGC filter	0.2V
㉑	AGC FILTER 2	Terminal pin for AGC filter	3.0V
㉒	Y IN (Luminance signal input)	Input pin for luminance signal. This pin can be pedestal-clamped. Sync negative signal with standard amplitude 0.5V _{p-p} is input.	
㉓	- VEE	Pin for connection with - 7.5V power supply.	
㉔	AGC OUT (AGC level output)	Output pin for operating point of AGC. AGC operation causes voltage drop.	3.5V
㉕	Vcc	Pin for connection with +4.5V power supply for interface section	
㉖	SELECT	Used for changeover between internal and external signals: "H" for external, "L" for internal.	
㉗	HP IN	Input pin for external synch signal. When this pin is to be used simultaneously with SYNC SEPA OUT pin, input signal must rise earlier than synch separation output.	(V _{th} = 2.5V)
㉘	POLARITY REVERSE	Used to control reversed polarity of output.	
㉙	SYNC SEPA IN	Input pin for sync separation signal. Sync negative video signal of 1VP-P is input.	2.0V
㉚	BURST GATE TIME CONSTANT	Time constant at this pin determines burst gate width. Starting from trailing edge of sync separation output, pin generates burst gate pulse of duration determined by this time constant.	(V _{th} = 2.5V)
㉛	COMMON IN (Inversion input)	Input pin for output-inverting pulse. Common output and RGB output are inverted simultaneously. RGB output polarity is reversed by POLARITY REVERSE pin.	(V _{th} = 2.2V)
㉜	COMMON OUT	Output pin for common driver.	- 6.5V
㉝	COMMON CONT (Common driver control)	Used to set output amplitude of common electrode driver.	($\approx 4.0V_{DC}$)
㉞	SYNC SEPA OUT	Output pin for sync separation signal. Sync positive signal is output through open collector. Connect this pin with load resistor.	
㉟	CLAMP FILTER B (B clamping capacitance)	Pin for connection with B-signal clamping capacitance	2.0V
㊱	CLAMP FILTER G (G clamping capacitance)	Pin for connection with G-signal clamping capacitance	
㊲	CLAMP FILTER R (R clamping capacitance)	Pin for connection with R-signal clamping capacitance	
㊳	BRIGHT (Luminance control)	Used to control luminance. Picture becomes brighter as voltage is increased.	($\approx 1.0V_{DC}$)
㊴	Y CONT	Used to set γ value of γ amplifier. Connect this terminal to power source if γ amplifier is unnecessary.	
㊵	GND	Pin for connection to ground. Connect this terminal to GND.	
㊶	SUB BIAS-R	Used to set R signal bias.	($\approx 1.7V_{DC}$)
㊷	SUB BIAS-G	Used to set G signal bias.	
㊸	SUB BIAS-B	Used to set B signal bias.	
㊹	FEEDBACK-R	DC feedback pin for R output. Integrated R output is input. Connect this pin, when not used, to - VEE.	
㊺	R OUT 2	Output pin for R signal. Inverted signal is output.	(Output of $\approx 7VP-P$)

M52003AFP

PAL VIDEO CHROMA INTERFACE

DESCRIPTION OF PIN (cont.)

Pin No.	Name	Function	DC voltage (V)
④⑤	FEEDBACK - G	DC feedback pin for G output	
④⑦	G OUT 2	Output pin for G signal	(Output of 7V _{p-p})
④⑧	FEEDBACK - B	DC feedback pin for B output	
④⑨	B OUT 2	Output pin for B signal	(Output of 7V _{p-p})
⑤⑩	BIAS (Feedback center voltage)	Pin for reference voltage of output feedback. Output center voltage changes with voltage at this pin. For stabilization, ground this pin via appropriate capacitance.	- 1.8V
⑤⑪	HD IN	Used to input HD signal that drives line pulse generating flip-flop. F/F changes during HD fall time.	
⑤⑫	KILLER OUT	Output pin for killer signal. This pin outputs "H" signal when killer is actuated.	
⑤⑬	- VEE	Pin for connection with -7.5V power supply. This pin has same voltage as pin 23.	
⑤⑭	CHROMA IN	Input pin for chroma signal. Standard burst level is 100 mV _{p-p}	
⑤⑮	KILLER FILTER	Pin for connection with killer filter	3.0V
⑤⑯	ACC FILTER	Used to set ACC time constant.	0.5V
⑤⑰	COLOR CONT	Used to adjust color level. Color saturation increases when voltage at this pin is raised.	(Output of 1.7V _{DC})
⑤⑱	ACC AUT	Output pin for ACC-processed chroma signal. Chroma signal is passed through 1H delay line before being input to demodulator. Signal without color burst component is output to this pin.	2.0V
⑤⑲	BURST CLEANING COIL	Pin for connection with burst cleaning coil. Demodulated phase angle is controlled by coil.	
⑥①	V _{CC}	Pin for connection with +4.5 V power supply for video/chroma system.	

M52003AFP

PAL VIDEO CHROMA INTERFACE

PAL/SECAM APPLICATION EXAMPLE DUAL SYSTEM

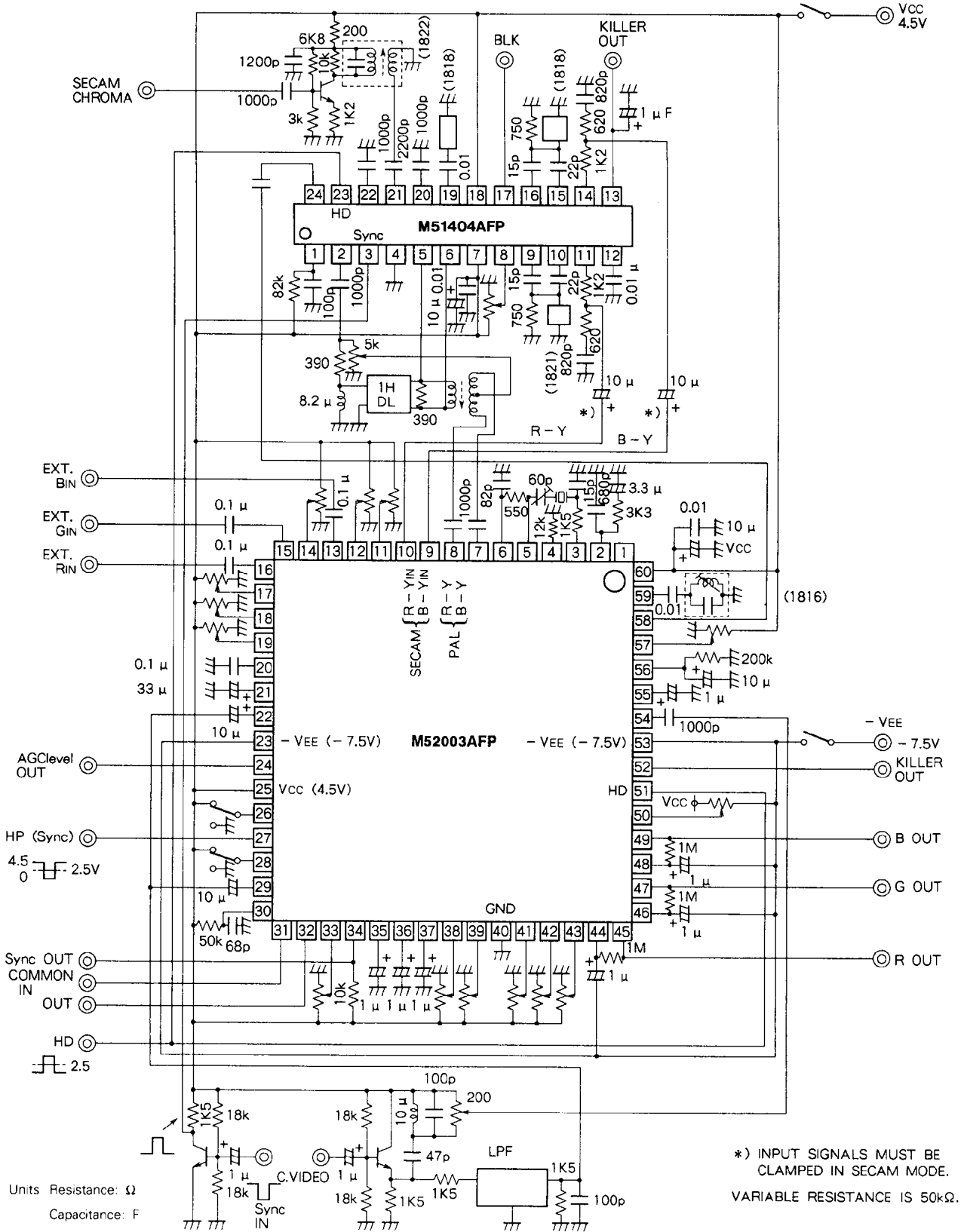

M52003AFP

PAL VIDEO CHROMA INTERFACE

DESCRIPTION OF FUNCTIONS

The M52003AFP has the following functions:

- **Video AGC:** Processes input luminance signal amplitude by AGC using mean value, to minimize contrast fluctuation and reduce black or white compression of picture. AGC operation level is output to AGC LEVEL pin. Standard input level is 0.5V_{P-P}.
- **Picture quality control:**
Controls frequency characteristics of luminance signal by DC voltage.
- **Matrix:** Produces RGB signal from luminance and color difference signals in matrix, outputs signal to INT/EXT SWITCH block.
- **ACC:** Processes input chroma signal by ACC, outputs signal to CHROMA OUT pin. Color burst component is removed by burst gate pulse; chroma output is cut when killer is actuated. ACC range is between -20 and 6dB. (100mV_{P-P} burst level is set at 0dB.)
- **Killer:** Generates chroma output when PLL is locked with input chroma signal and HD signal-driven flip-flop polarity conforms to that of input. Killer ON/OFF signal is output to KILLER OUT pin. SECAM switch is operated by killer.
- **VCXO and APC:** These functions constitute PLL which locks input chroma signal. Standard lock range is 1kHz.
- **IDENT:** Conforms HD signal-driven flip-flop polarity to that of input chroma signal color burst component phase. Killer is actuated if IDENT circuit does not function normally.
- **Burst cleaning:** ... Passes color burst signal through tuning circuit to minimize noise influence before signal input to APC and ACC. Chroma signal phase can be adjusted by this function.
- **Color decoder:** ... Demodulates PAL chroma signal processed by ACC into color difference signal; sends it to matrix.
- **PAL/SECAM switch:**
Selects PAL or SECAM color difference signal to be input to matrix, depending on killer ON/OFF. PAL-demodulated color difference signal is selected by OFF signal, SECAM color difference signal by ON signal.
- **Flip-flop (F/F):** ... Generates line pulse inverted at 1H intervals as triggered by HD signal. Line pulse polarity is conformed by IDENT circuit to that of input chroma signal color burst component phase.
- **Contrast:** Controls amplitude of matrix-produced RGB signal.
- **Gain control B:** .. Controls B signal gain to adjust white balance.
- **Gain control R:** .. Controls R signal gain.
- **INT/EXT switch:** Selects external RGB signal or internal signal produced in matrix from color difference and Y components of video signal.
- **Clamp control:** ... Maintains constancy of pedestal level of internal signal or external signal.
- **Luminance control:**
Controls luminance of INT/EXT switch output after clamping. γ amplifier operating point changes with luminance level.
- **γ amplifier:** Nonlinear amplifier adjusts drive signal to γ curve peculiar to LCD. Nonlinearity changes with γ value.
- **Bias inversion stage:**
Independently controls R, G and B signal inversion amplitude to adjust white balance. Panel drive signal amplitude is sum of bias amount and common electrode amplitude.
- **Sync separation/Burst gate:**
Sync separation circuit output is sent to SYNCSEPAOUT pin. Simultaneously, it is added to HP pulse and sent to burst gate generator. When no signal is input, HP pulse must be used for clamping.
- **Common electrode driver:**
Drives common electrodes of LCD panel. Output is inverted according to inversion signal. Polarity can be reversed, although RGB outputs are inverted simultaneously.
- **RGB output stage:**
Feeds back signal obtained by integrating driver signal to align output center with dynamic range center. DC component applied to LCD panel is minimized by this function. (When this function is not used, connect FEEDBACK pins to -V_{CC} pin.)