



TS1871
TS1872
TS1874

1.8V INPUT/OUTPUT RAIL TO RAIL LOW POWER OPERATIONAL AMPLIFIERS

- OPERATING AT $V_{CC} = 1.8V$ to $6V$
- RAIL TO RAIL INPUT & OUTPUT
- EXTENDED V_{icm} ($V_{DD} - 0.2V$ to $V_{CC} + 0.2V$)
- LOW SUPPLY CURRENT ($400\mu A$)
- GAIN BANDWIDTH PRODUCT ($1.6MHz$)
- HIGH STABILITY
- ESD TOLERANCE ($2kV$)
- LATCH-UP IMMUNITY
- AVAILABLE IN SOT23-5 MICROPACKAGE

DESCRIPTION

The TS187x (Single, Dual & Quad) is an operational amplifier family able to operate with voltage as low as 1.8V and features both I/O Rail to Rail.

The common mode input voltage extends 200mV at 25°C beyond the supply voltages while the output voltage swing is within 100mV of each Rail with 600 Ohm load resistor. This device consumes typically 400µA per channel while offering 1.6Mhz of gain-bandwidth product. The amplifier provides high output drive capability typically at 65mA-load.

These performances make the TS187X family ideal for sensor interface, battery-supplied and portable applications.

APPLICATION

- Battery-powered applications (Toys)
- Portable communication devices (cell phone)
- Audio driver (Headphone Driver)
- Laptop/Notebook computers

ORDER CODE

Part Number	Temperature Range	Package					SOT23 Marking
		N	D	P	L	S	
TS1871I/AI	-40, +125°C		•		•		K171/172
TS1872I/AI		•	•	•		•	K171/172
TS1874I/AI		•	•	•			

N = Dual in Line Package (DIP)
S = MiniSO Package (miniSO) - also available in Tape & Reel (ST)
D = Small Outline Package (SO) - also available in Tape & Reel (DT)
P = Thin Shrink Small Outline Package (TSSOP) - only available in Tape & Reel (PT)
L = Tiny Package (SOT23-5) - only available in Tape & Reel (LT)

PIN CONNECTIONS (top view)

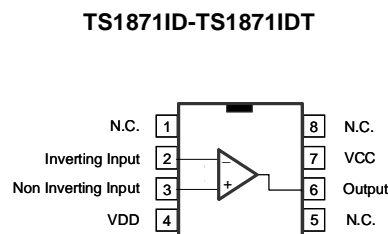
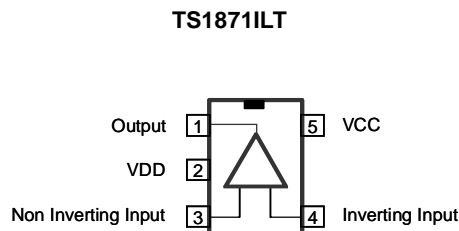

TS1872IST-TS1872IN-TS1872ID-TS1872IPT

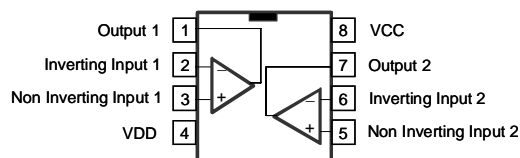

TS1874IN-TS1874ID-TS1874IDT-TS1874IPT

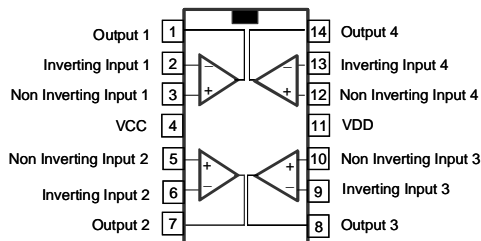

ABSOLUTE MAXIMUM RATINGS

Symbol	Parameter	Value	Unit
V_{CC}	Supply voltage ¹⁾	7	V
V_{id}	Differential Input Voltage ²⁾	± 1	V
V_i	Input Voltage ³⁾	$V_{DD}-0.3$ to $V_{CC} +0.3$	V
T_{stg}	Storage Temperature	-65 to +150	°C
T_j	Maximum Junction Temperature	150	°C
R_{thja}	Thermal Resistance Junction to Ambient ⁴⁾ SOT23-5 SO8 SO14 TSSOP8 TSSOP14 miniSO8	250 175 150 200 175 180	°C/W
ESD	Human Body Model	2	kV
	Latch-up Immunity	Class A	
	Lead Temperature (soldering, 10sec)	250	°C

1. All voltages values, except differential voltage are with respect to network terminal.
2. Differential voltages are non-inverting input terminal with respect to the inverting input terminal.
3. The magnitude of input and output voltages must never exceed $V_{CC} + 0.3V$.
4. Short-circuits can cause excessive heating. Destructive dissipation can result from simultaneous short-circuit on all amplifiers

OPERATING CONDITIONS

Symbol	Parameter	Value	Unit
V_{CC}	Supply Voltage	1.8 to 6	V
V_{icm}	Common Mode Input Voltage Range ¹⁾	$V_{DD} - 0.2$ to $V_{CC} + 0.2$	V
V_{icm}	Common Mode Input Voltage Range ²⁾	V_{DD} to V_{CC}	V
T_{oper}	Operating Free Air Temperature Range	-40 to + 125	°C

1. At 25°C, for $1.8 \leq V_{CC} \leq 6V$, V_{icm} is extended to $V_{DD} - 0.2V$, $V_{CC} + 0.2V$.
2. In full temperature range, both Rails can be reached when V_{CC} does not exceed 5.5V.

ELECTRICAL CHARACTERISTICS

$V_{CC} = +1.8V$, $V_{DD} = 0V$, R_L , C_L connected to $V_{CC}/2$, $T_{amb} = 25^\circ C$ (unless otherwise specified)

Symbol	Parameter	Min.	Typ.	Max.	Unit
V_{io}	Input Offset Voltage $V_{icm} = V_{out} = V_{CC}/2$ TS1871/2/4 TS1871A/2A/4A		0.1	3 1	mV
ΔV_{io}	Input Offset Voltage Drift		2		$\mu V/^\circ C$
I_{io}	Input Offset Current ¹⁾ $V_{icm} = V_{out} = V_{CC}/2$		3	30	nA
I_{ib}	Input Bias Current ¹⁾ $V_{icm} = V_{out} = V_{CC}/2$		40	125	nA
CMR	Common Mode Rejection Ratio $0 \leq V_{icm} \leq V_{CC}$, $V_{out} = V_{CC}/2$	55	77		dB
SVR	Supply Voltage Rejection Ratio	70	80		dB
A_{vd}	Large Signal Voltage Gain $V_{out} = 0.5V$ to $1.3V$ $R_L = 2k\Omega$ $R_L = 600\Omega$	77 70	92 85		dB
V_{OH}	High Level Output Voltage $V_{id} = 100mV$ $R_L = 2k\Omega$ $R_L = 600\Omega$	1.65 1.62	1.77 1.74		V
V_{OL}	Low Level Output Voltage $V_{id} = -100mV$ $R_L = 2k\Omega$ $R_L = 600\Omega$		88 115	100 150	mV
I_o	Output Source Current $V_{ID} = 100mV$, $V_O = V_{DD}$ Output Sink Current $V_{ID} = -100mV$, $V_O = V_{CC}$	20 20	65 65		mA
I_{CC}	Supply Current (per amplifier) $A_{VCL} = 1$, no load		400	560	μA
GBP	Gain Bandwidth Product $R_L = 10k\Omega$, $C_L = 100pF$, $f = 100kHz$	0.9	1.6		MHz
SR	Slew Rate $R_L = 10k\Omega$, $C_L = 100pF$, $AV = 1$	0.38	0.54		$V/\mu s$
ϕ_m	Phase Margin $C_L = 100pF$		53		Degrees
en	Input Voltage Noise		27		nV/\sqrt{Hz}
THD	Total Harmonic Distortion		0.01		%

1. Maximum values including unavoidable inaccuracies of the industrial test.

ELECTRICAL CHARACTERISTICS
 $V_{CC} = +3V$, $V_{DD} = 0V$, R_L , C_L connected to $V_{CC}/2$, $T_{amb} = 25^\circ C$ (unless otherwise specified)

Symbol	Parameter	Min.	Typ.	Max.	Unit
V_{io}	Input Offset Voltage $V_{icm} = V_{out} = V_{CC}/2$ TS1871/2/4 TS1871A/2A/4A		0.1	3 1	mV
ΔV_{io}	Input Offset Voltage Drift		2		$\mu V/^\circ C$
I_{io}	Input Offset Current ¹⁾ $V_{icm} = V_{out} = V_{CC}/2$		3	30	nA
I_{ib}	Input Bias Current ¹⁾ $V_{icm} = V_{out} = V_{CC}/2$		4	125	nA
CMR	Common Mode Rejection Ratio $0 \leq V_{icm} \leq V_{CC}$, $V_{out} = V_{CC}/2$	60	80		dB
SVR	Supply Voltage Rejection Ratio	70	85		dB
A_{vd}	Large Signal Voltage Gain $V_{out} = 0.5V$ to $2.5V$ $R_L = 2k\Omega$ $R_L = 600\Omega$	80 74	92 95		dB
V_{OH}	High Level Output Voltage $V_{id} = 100mV$ $R_L = 2k\Omega$ $R_L = 600\Omega$	2.82 2.80	2.95 2.95		V
V_{OL}	Low Level Output Voltage $V_{id} = -100mV$ $R_L = 2k\Omega$ $R_L = 600\Omega$		88 115	120 160	mV
I_o	Output Source Current $V_{ID} = 100mV$, $V_O = V_{DD}$ Output Sink Current $V_{ID} = -100mV$, $V_O = V_{CC}$	20 20	80 80		mA
I_{CC}	Supply Current (per amplifier) $A_{VCL} = 1$, no load		450	650	μA
GBP	Gain Bandwidth Product $R_L = 10k\Omega$, $C_L = 100pF$, $f = 100kHz$	1	1.7		MHz
SR	Slew Rate $R_L = 10k\Omega$, $C_L = 100pF$, $AV = 1$	0.42	0.6		$V/\mu s$
ϕ_m	Phase Margin $C_L = 100pF$		53		Degrees
en	Input Voltage Noise		27		nV/\sqrt{Hz}
THD	Total Harmonic Distortion		0.01		%

1. Maximum values including unavoidable inaccuracies of the industrial test.

ELECTRICAL CHARACTERISTICS $V_{CC} = +5V$, $V_{DD} = 0V$, R_L , C_L connected to $V_{CC}/2$, $T_{amb} = 25^\circ C$ (unless otherwise specified)

Symbol	Parameter	Min.	Typ.	Max.	Unit
V_{io}	Input Offset Voltage $V_{icm} = V_{out} = V_{CC}/2$ TS1871/2/4 TS1871A/2A/4A		0.1	3 1	mV
ΔV_{io}	Input Offset Voltage Drift		2		$\mu V/^\circ C$
I_{io}	Input Offset Current ¹⁾ $V_{icm} = V_{out} = V_{CC}/2$		3	30	nA
I_{ib}	Input Bias Current ¹⁾ $V_{icm} = V_{out} = V_{CC}/2$		70	130	nA
CMR	Common Mode Rejection Ratio $0 \leq V_{icm} \leq V_{CC}$, V_{out} different of $V_{CC}/2$	65	85		dB
SVR	Supply Voltage Rejection Ratio	70	90		dB
A_{vd}	Large Signal Voltage Gain $V_{out} = 1V$ to $4V$ $R_L = 2k\Omega$ $R_L = 600\Omega$	83 77	92 85		dB
V_{OH}	High Level Output Voltage $V_{id} = 100mV$ $R_L = 2k\Omega$ $R_L = 600\Omega$	4.80 4.75	4.95 4.90		V
V_{OL}	Low Level Output Voltage $V_{id} = -100mV$ $R_L = 2k\Omega$ $R_L = 600\Omega$		88 115	130 188	mV
I_o	Output Source Current $V_{ID} = 100mV$, $V_O = V_{DD}$ Output Sink Current $V_{ID} = -100mV$, $V_O = V_{CC}$	20 20	80 80		mA
I_{CC}	Supply Current (per amplifier) $A_{VCL} = 1$, no load		500	835	μA
GBP	Gain Bandwidth Product $R_L = 10k\Omega$, $C_L = 100pF$, $f = 100kHz$	1	1.8		MHz
SR	Slew Rate $R_L = 10k\Omega$, $C_L = 100pF$, $AV = 1$	0.42	0.6		$V/\mu s$
ϕ_m	Phase Margin $C_L = 100pF$		55		Degrees
en	Input Voltage Noise		27		nV/\sqrt{Hz}
THD	Total Harmonic Distortion		0.01		%

1. Maximum values including unavoidable inaccuracies of the industrial test.

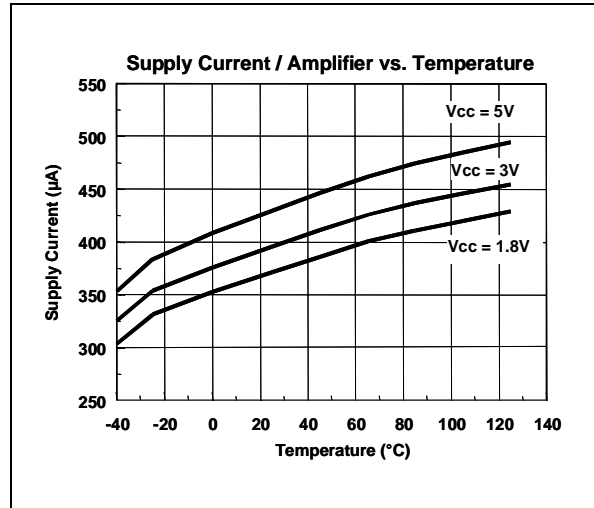
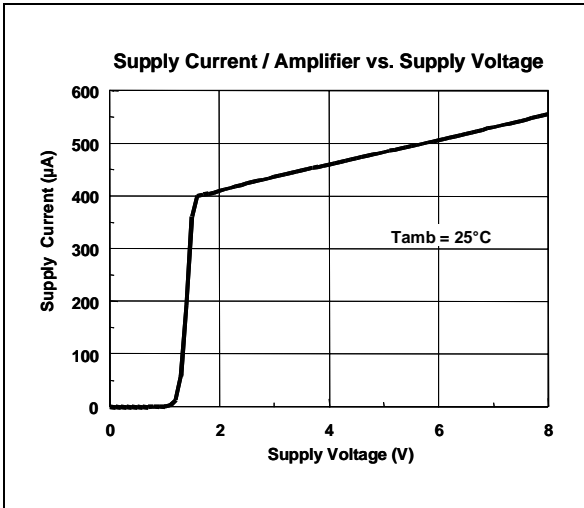
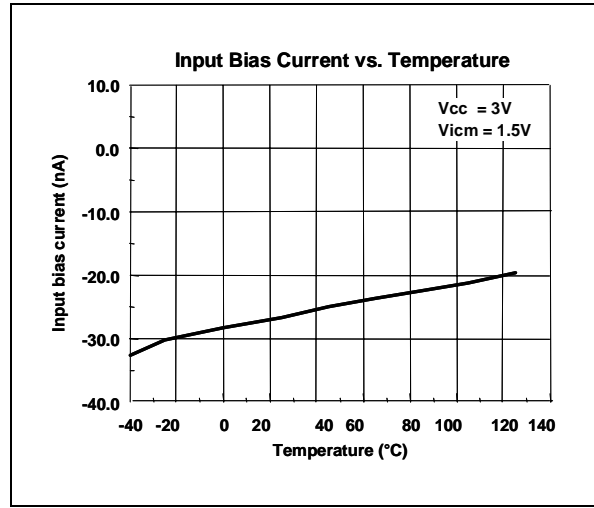
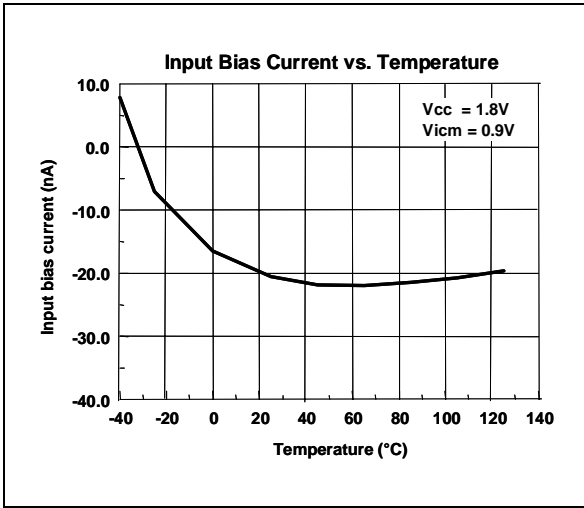
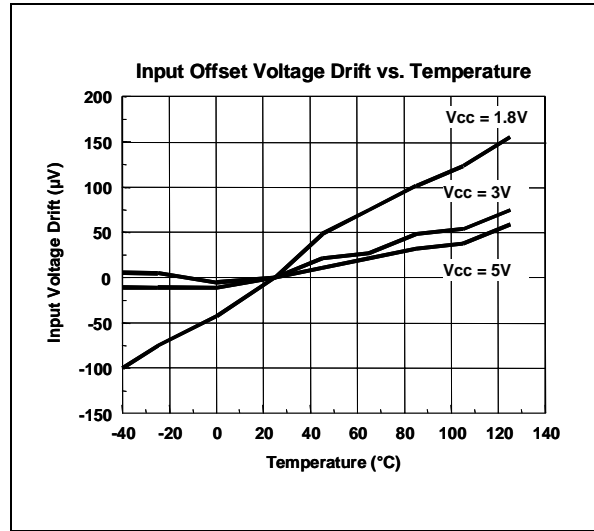
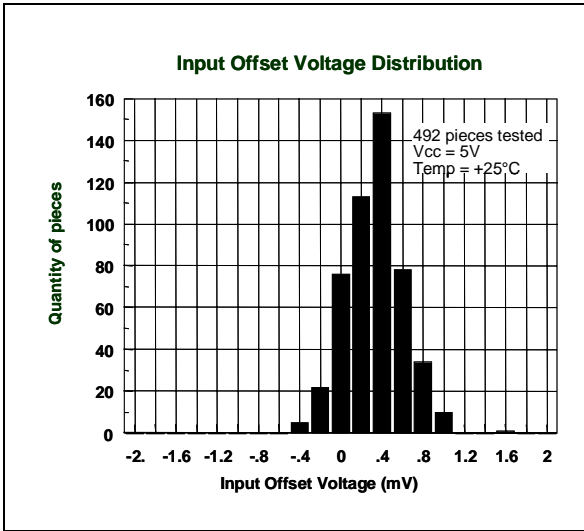

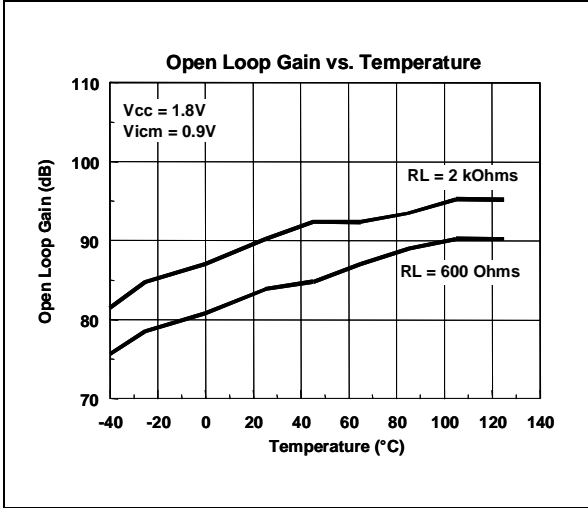
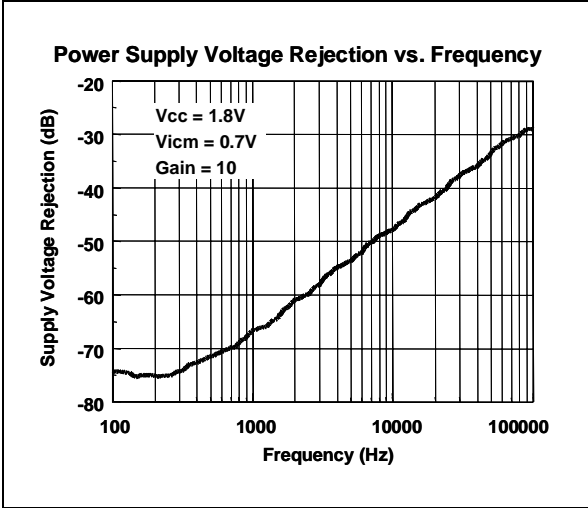
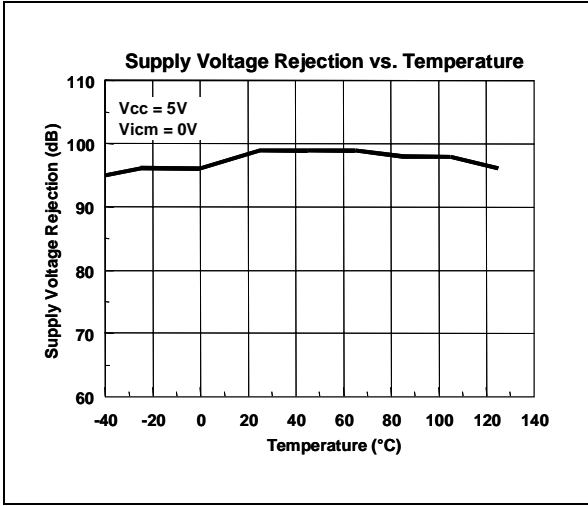
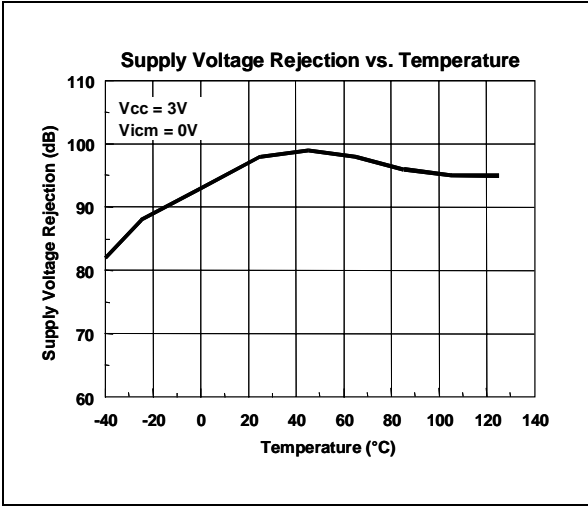
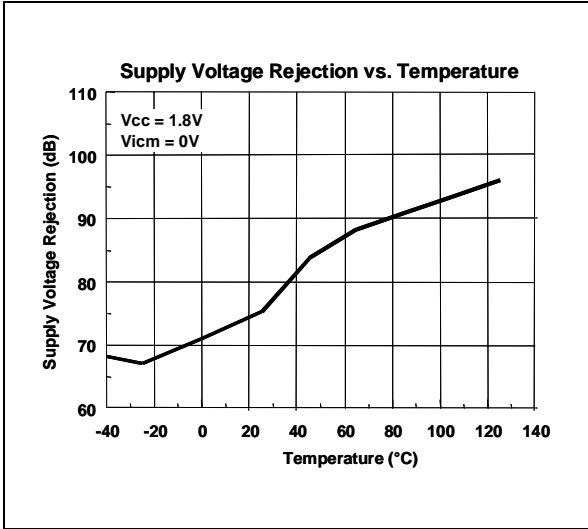
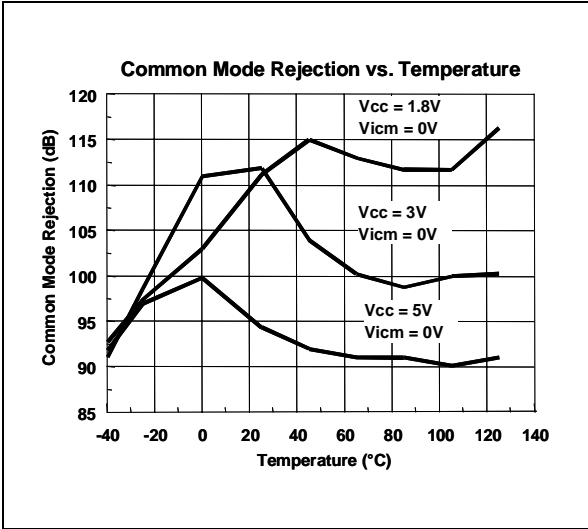

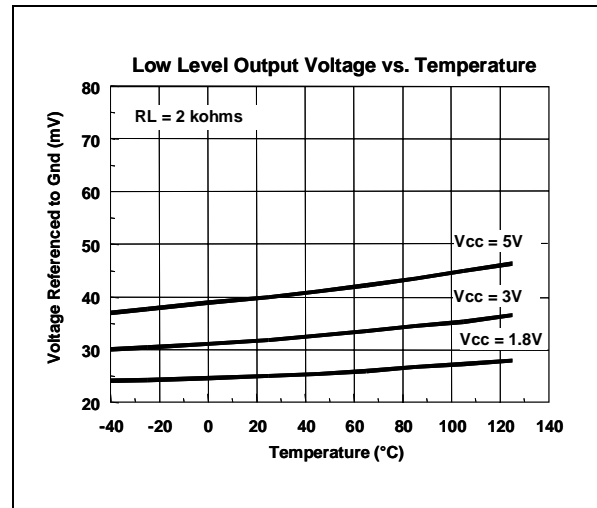
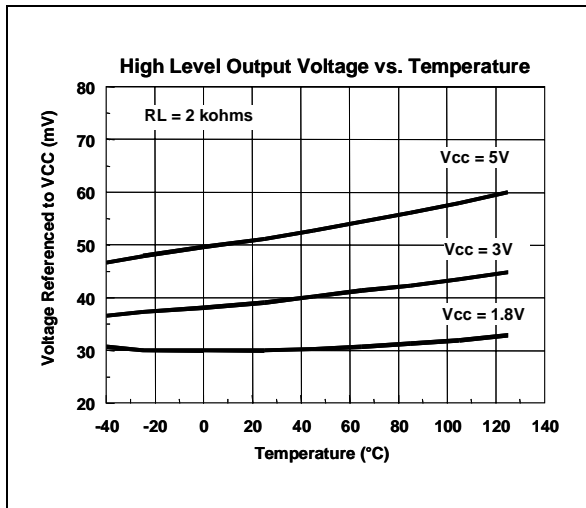
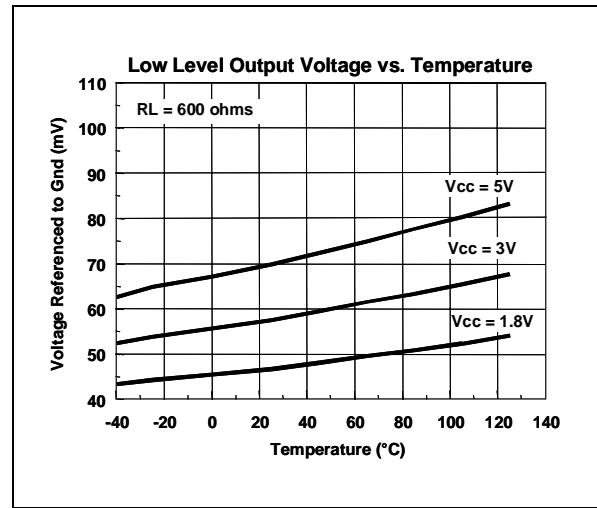
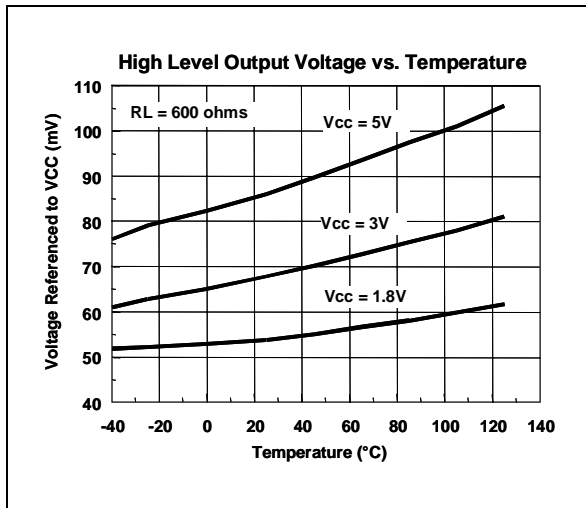
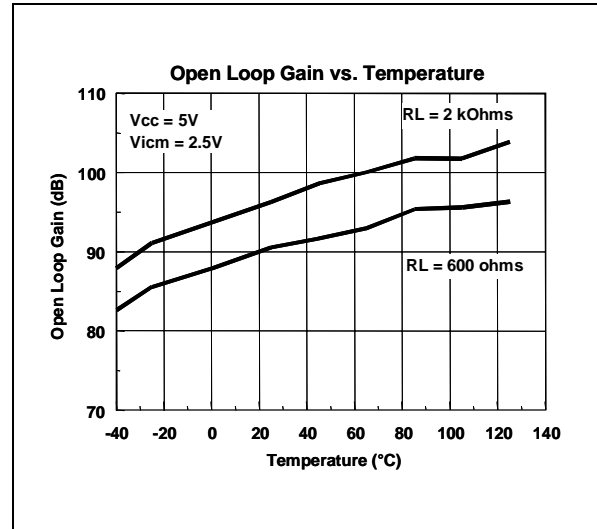
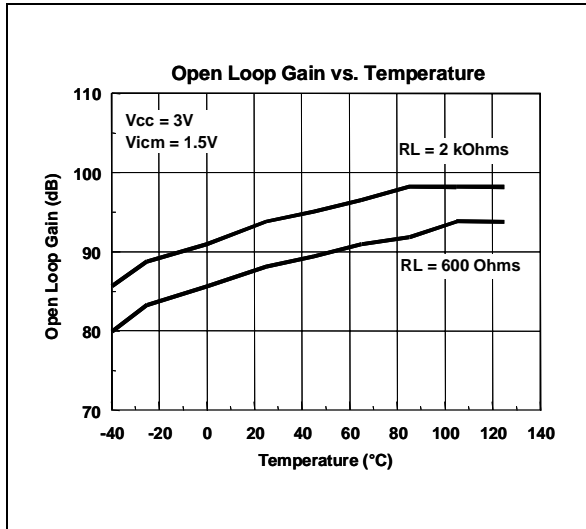

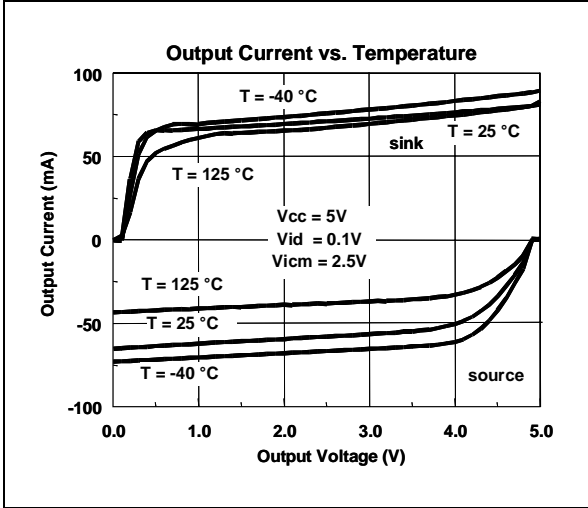
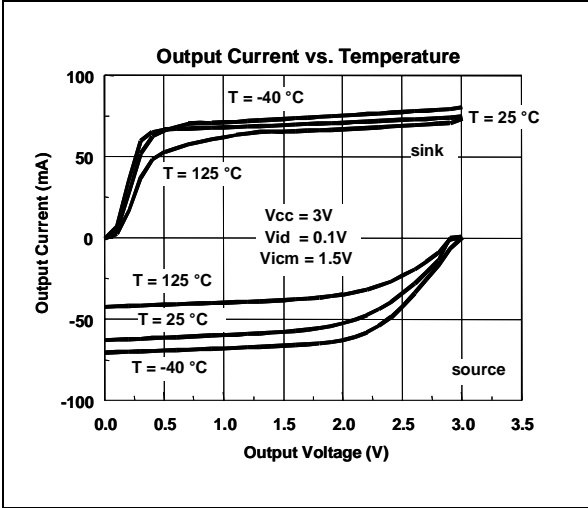
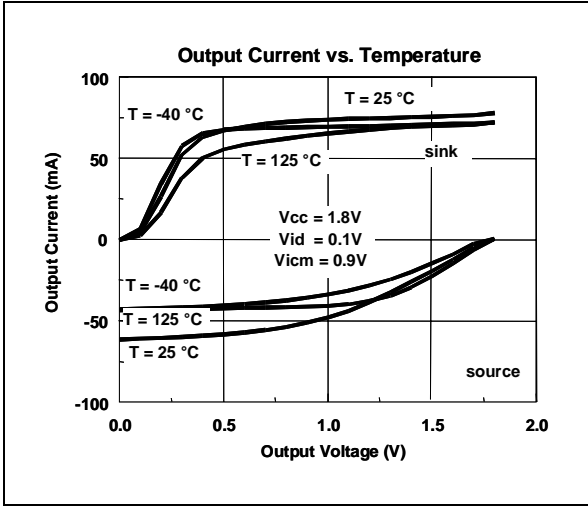
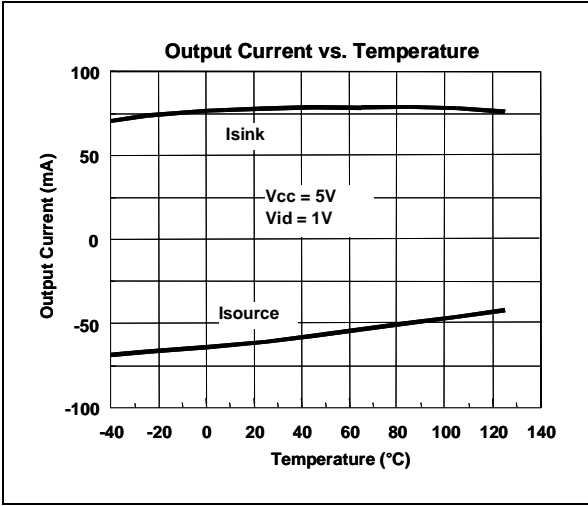
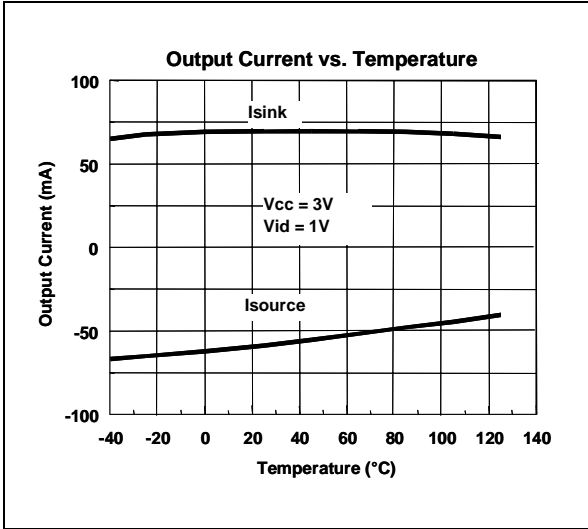
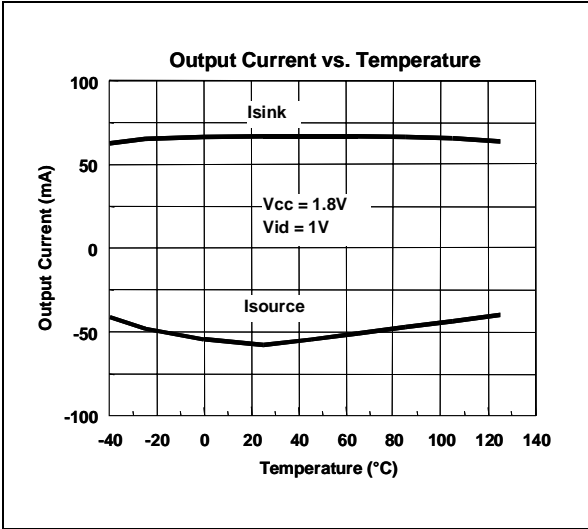

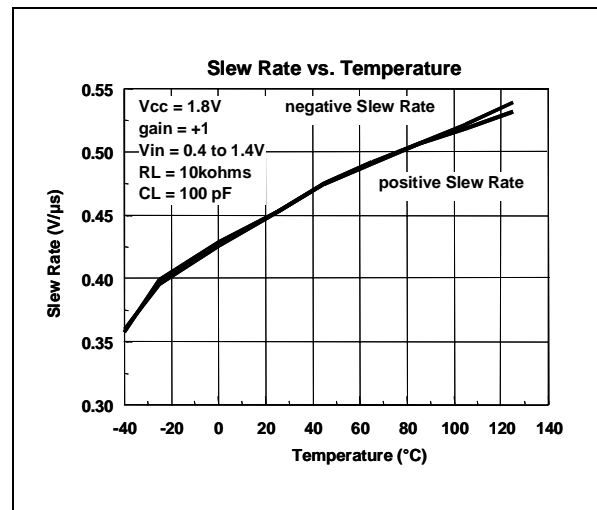
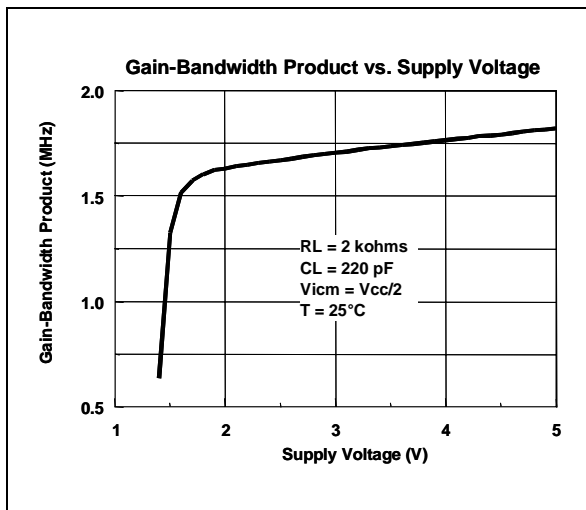
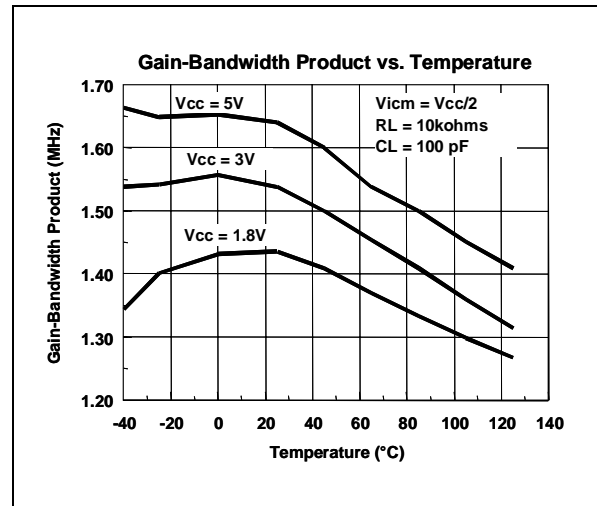
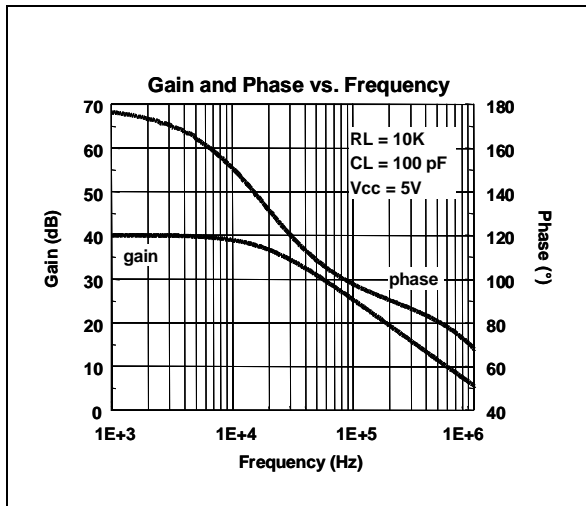
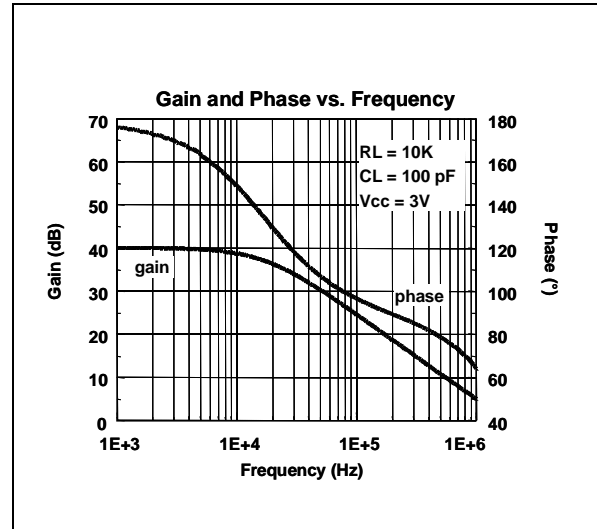
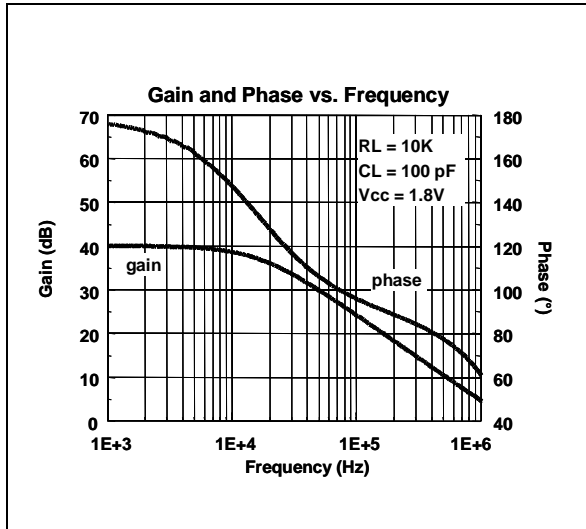

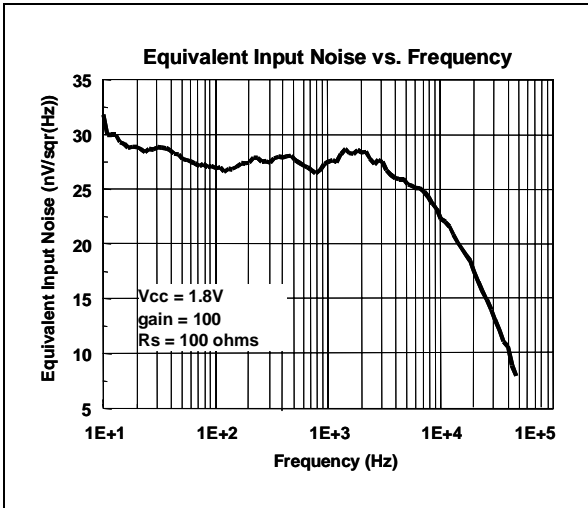
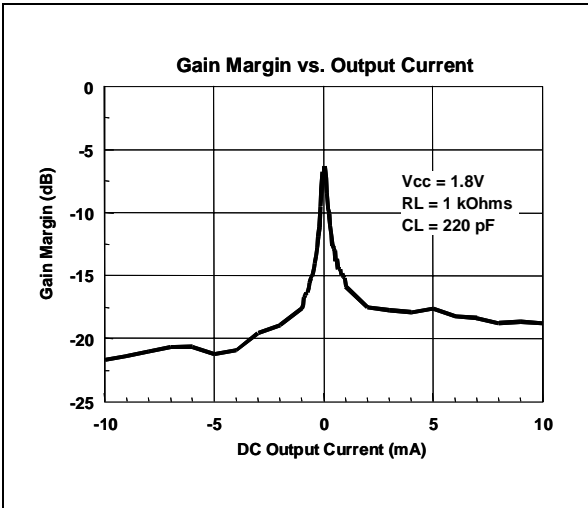
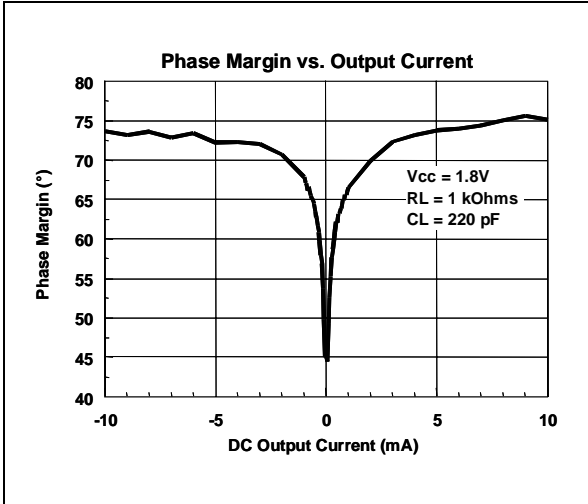
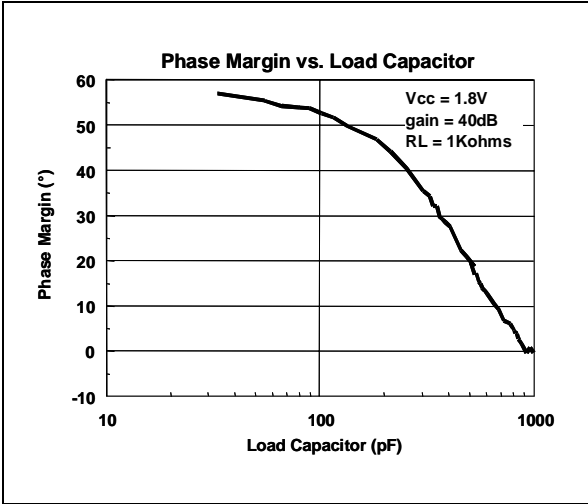
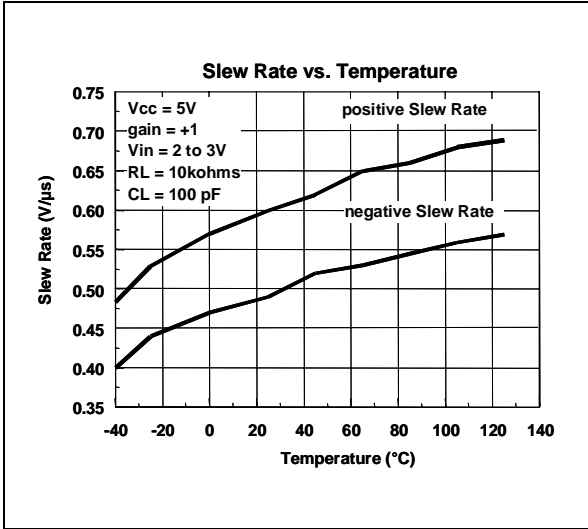
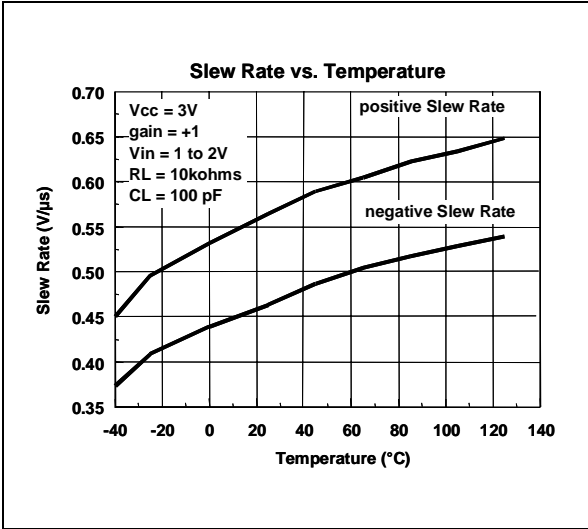

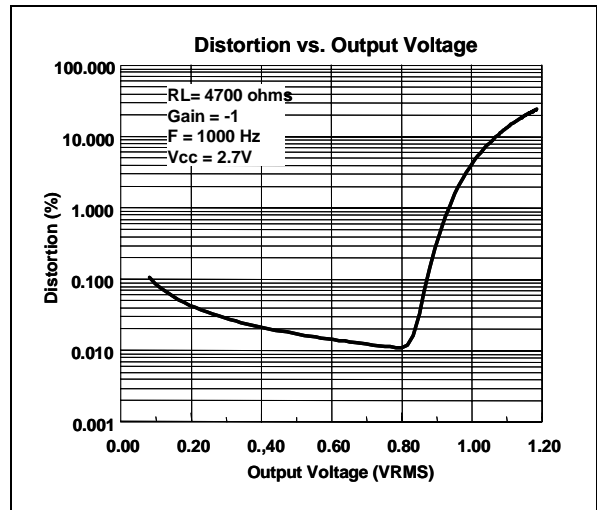
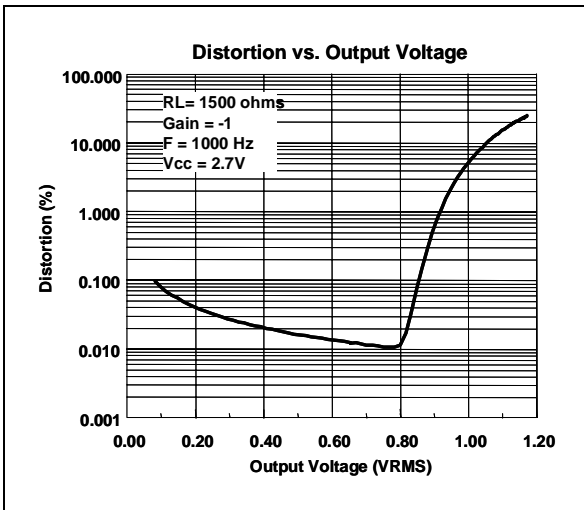
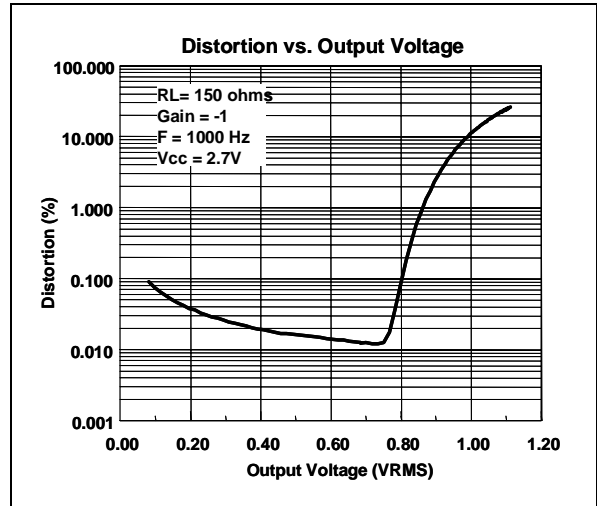
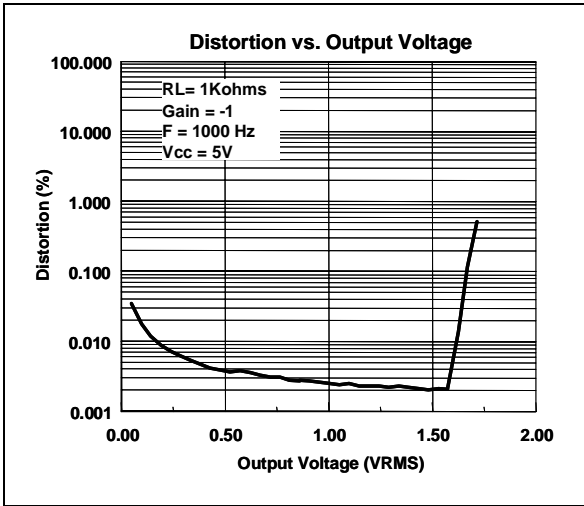
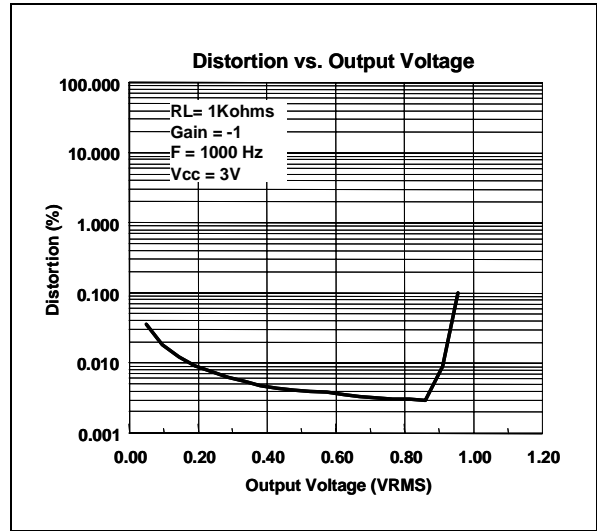
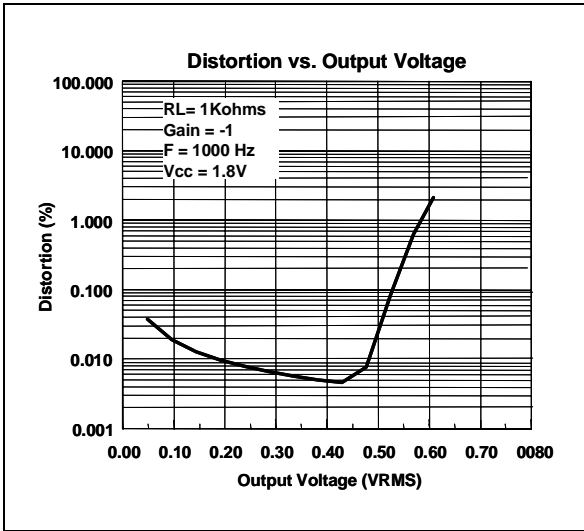

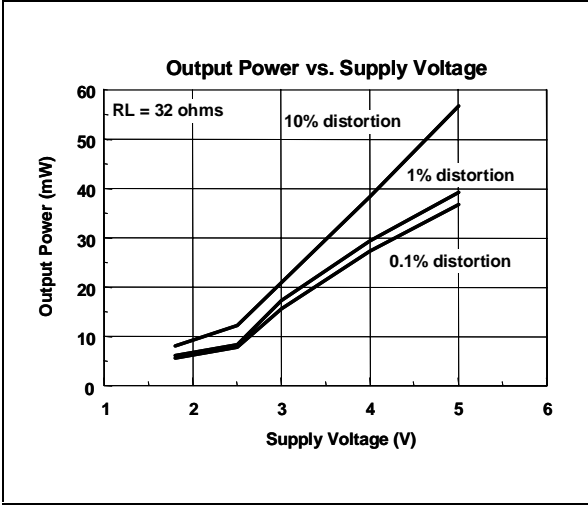
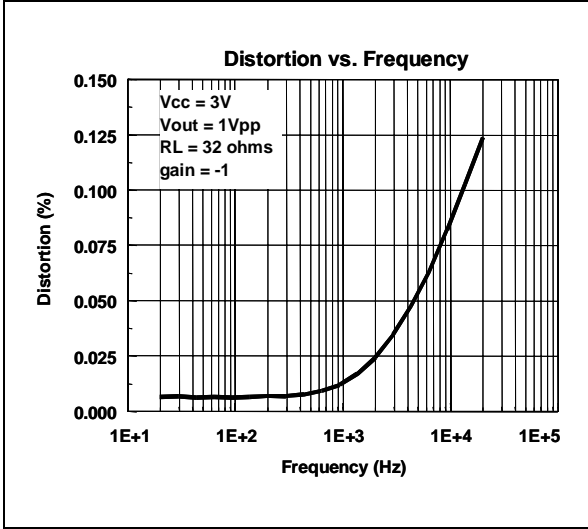
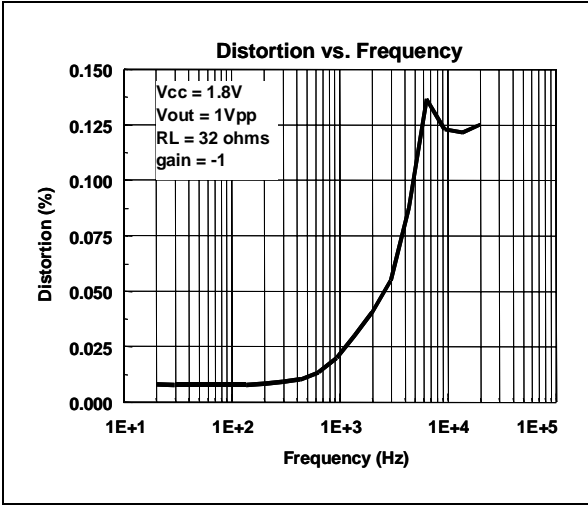
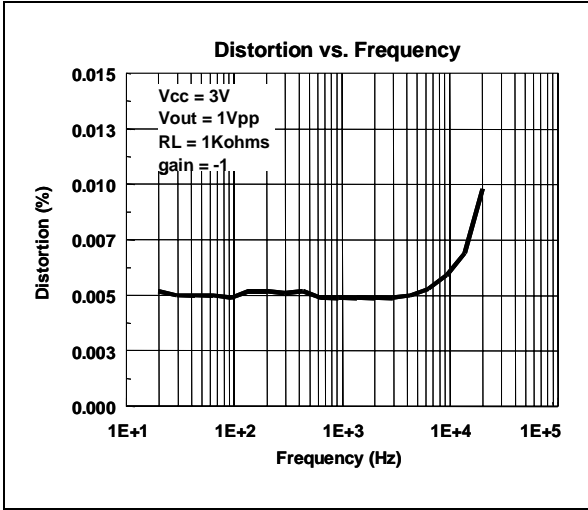
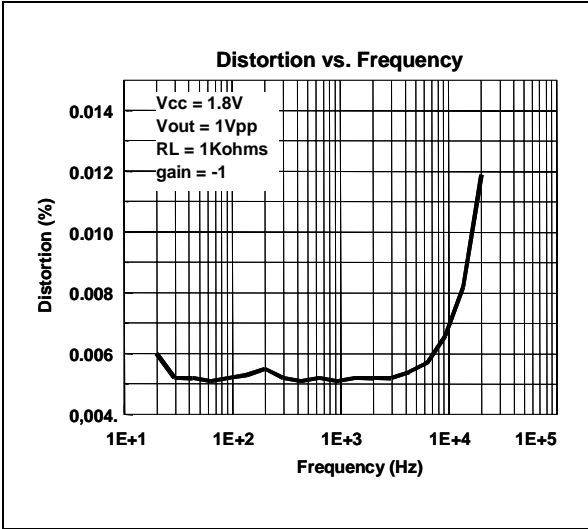

TS1872IN

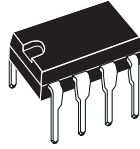

PACKAGE MECHANICAL DATA

8 PINS - PLASTIC DIP

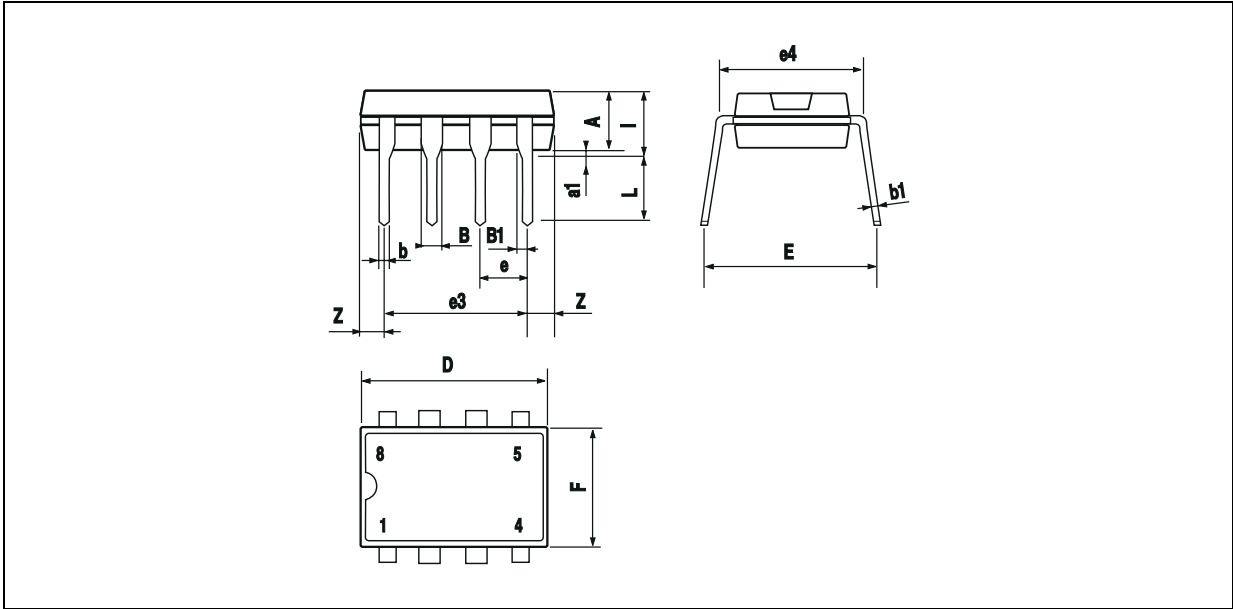

Dimensions	Millimeters			Inches		
	Min.	Typ.	Max.	Min.	Typ.	Max.
A		3.32			0.131	
a1	0.51			0.020		
B	1.15		1.65	0.045		0.065
b	0.356		0.55	0.014		0.022
b1	0.204		0.304	0.008		0.012
D			10.92			0.430
E	7.95		9.75	0.313		0.384
e		2.54			0.100	
e3		7.62			0.300	
e4		7.62			0.300	
F			6.6			0.260
i			5.08			0.200
L	3.18		3.81	0.125		0.150
Z			1.52			0.060

TS1871ID - TS1872ID



PACKAGE MECHANICAL DATA
8 PINS - PLASTIC MICROPACKAGE (SO)

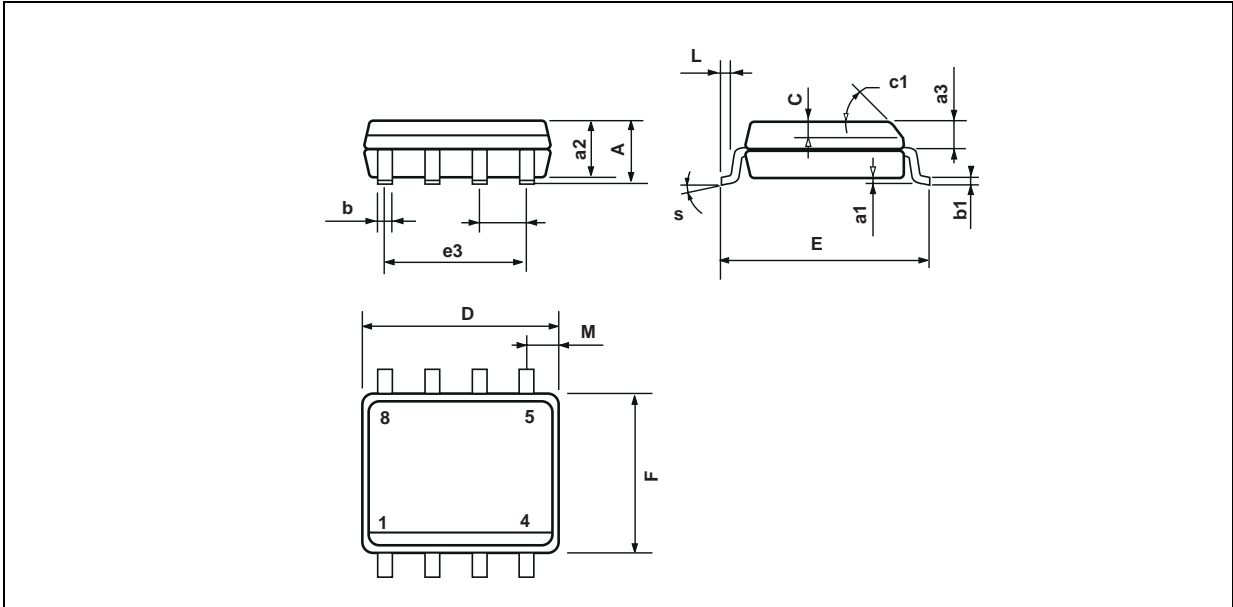

Dimensions	Millimeters			Inches		
	Min.	Typ.	Max.	Min.	Typ.	Max.
A		3.32			0.131	
a1	0.51			0.020		
B	1.15		1.65	0.045		0.065
b	0.356		0.55	0.014		0.022
b1	0.204		0.304	0.008		0.012
D			10.92			0.430
E	7.95		9.75	0.313		0.384
e		2.54			0.100	
e3		7.62			0.300	
e4		7.62			0.300	
F			6.6			0.260
i			5.08			0.200
L	3.18		3.81	0.125		0.150
Z			1.52			0.060

TS1872IPT



PACKAGE MECHANICAL DATA

8 PINS - THIN SHRINK SMALL OUTLINE PACKAGE

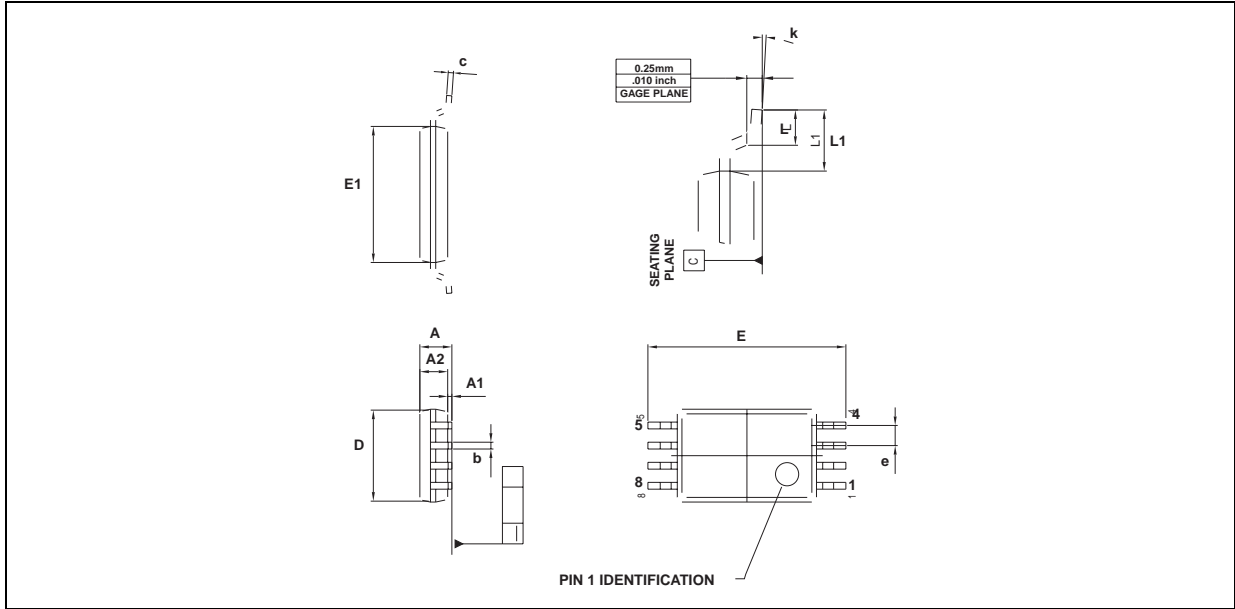

Dimensions	Millimeters			Inches		
	Min.	Typ.	Max.	Min.	Typ.	Max.
A			1.20			0.05
A1	0.05		0.15	0.01		0.006
A2	0.80	1.00	1.05	0.031	0.039	0.041
b	0.19		0.30	0.007		0.15
c	0.09		0.20	0.003		0.012
D	2.90	3.00	3.10	0.114	0.118	0.122
E		6.40			0.252	
E1	4.30	4.40	4.50	0.169	0.173	0.177
e		0.65			0.025	
k	0°		8°	0°		8°
l	0.50	0.60	0.75	0.09	0.0236	0.030
L	0.45	0.600	0.75	0.018	0.024	0.030
L1		1.000			0.039	

TS1874IN

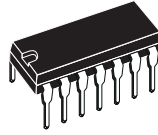

PACKAGE MECHANICAL DATA

14 PINS - PLASTIC DIP

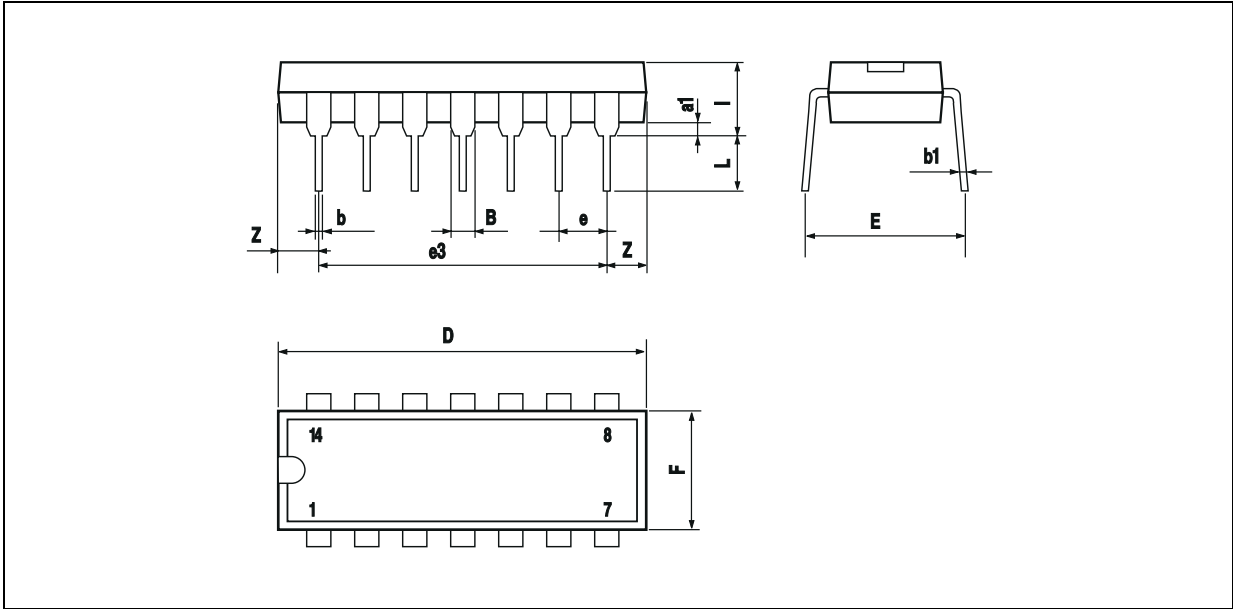

Dimensions	Millimeters			Inches		
	Min.	Typ.	Max.	Min.	Typ.	Max.
a1	0.51			0.020		
B	1.39		1.65	0.055		0.065
b		0.5			0.020	
b1		0.25			0.010	
D			20			0.787
E		8.5			0.335	
e		2.54			0.100	
e3		15.24			0.600	
F			7.1			0.280
i			5.1			0.201
L		3.3			0.130	
Z	1.27		2.54	0.050		0.100

TS1874ID

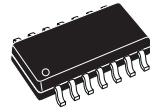

PACKAGE MECHANICAL DATA
14 PINS - PLASTIC MICROPACKAGE (SO)

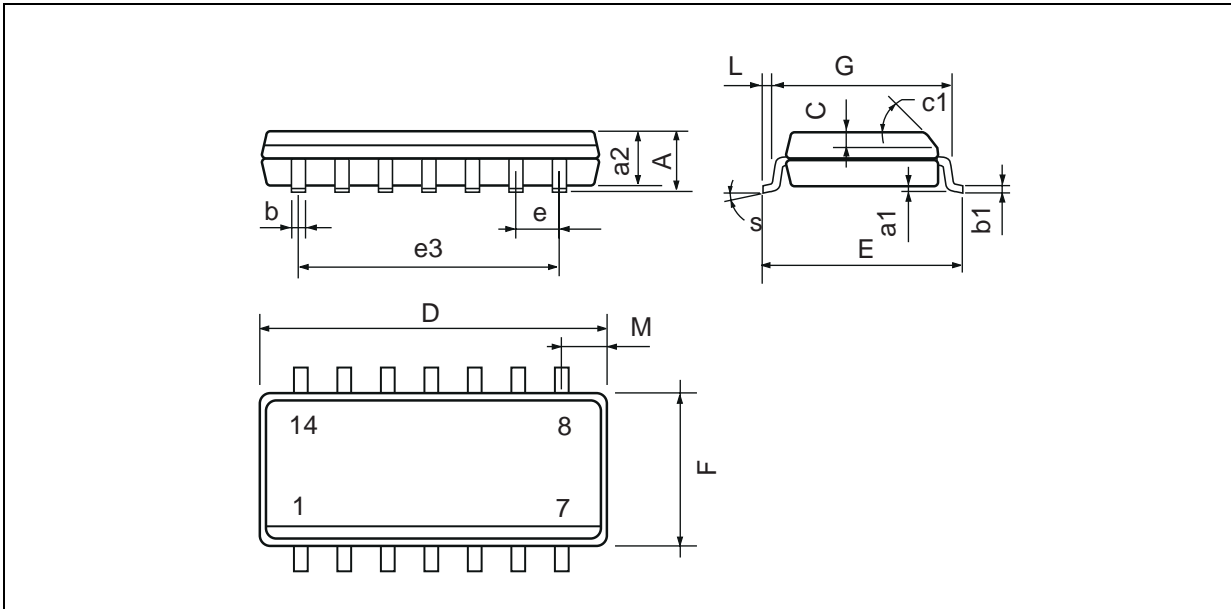

Dimensions	Millimeters			Inches		
	Min.	Typ.	Max.	Min.	Typ.	Max.
A			1.75			0.069
a1	0.1		0.2	0.004		0.008
a2			1.6			0.063
b	0.35		0.46	0.014		0.018
b1	0.19		0.25	0.007		0.010
C		0.5			0.020	
c1	45° (typ.)					
D (1)	8.55		8.75	0.336		0.344
E	5.8		6.2	0.228		0.244
e		1.27			0.050	
e3		7.62			0.300	
F (1)	3.8		4.0	0.150		0.157
G	4.6		5.3	0.181		0.208
L	0.5		1.27	0.020		0.050
M			0.68			0.027
S	8° (max.)					

Note : (1) D and F do not include mold flash or protrusions - Mold flash or protrusions shall not exceed 0.15mm (.066 inc) ONLY FOR DATA BOOK.

TS1874IPT

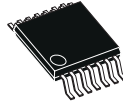

PACKAGE MECHANICAL DATA
14 PINS - THIN SHRINK SMALL OUTLINE PACKAGE

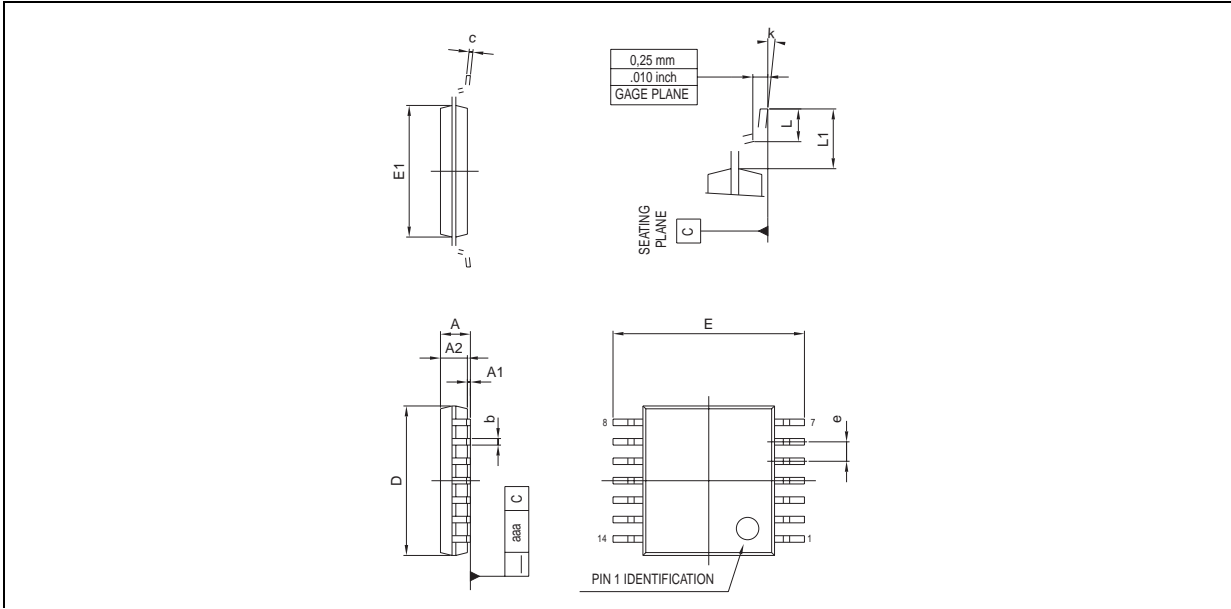

Dimensions	Millimeters			Inches		
	Min.	Typ.	Max.	Min.	Typ.	Max.
A			1.20			0.05
A1	0.05		0.15	0.01		0.006
A2	0.80	1.00	1.05	0.031	0.039	0.041
b	0.19		0.30	0.007		0.15
c	0.09		0.20	0.003		0.012
D	4.90	5.00	5.10	0.192	0.196	0.20
E		6.40			0.252	
E1	4.30	4.40	4.50	0.169	0.173	0.177
e		0.65			0.025	
k	0°		8°	0°		8°
L	0.450	0.600	0.750	0.018	0.024	0.030
L1		1.00			0.039	
aaa			0.100			0.004

TS1871ILT

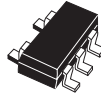

PACKAGE MECHANICAL DATA
5 PINS - TINY PACKAGE (SOT23)

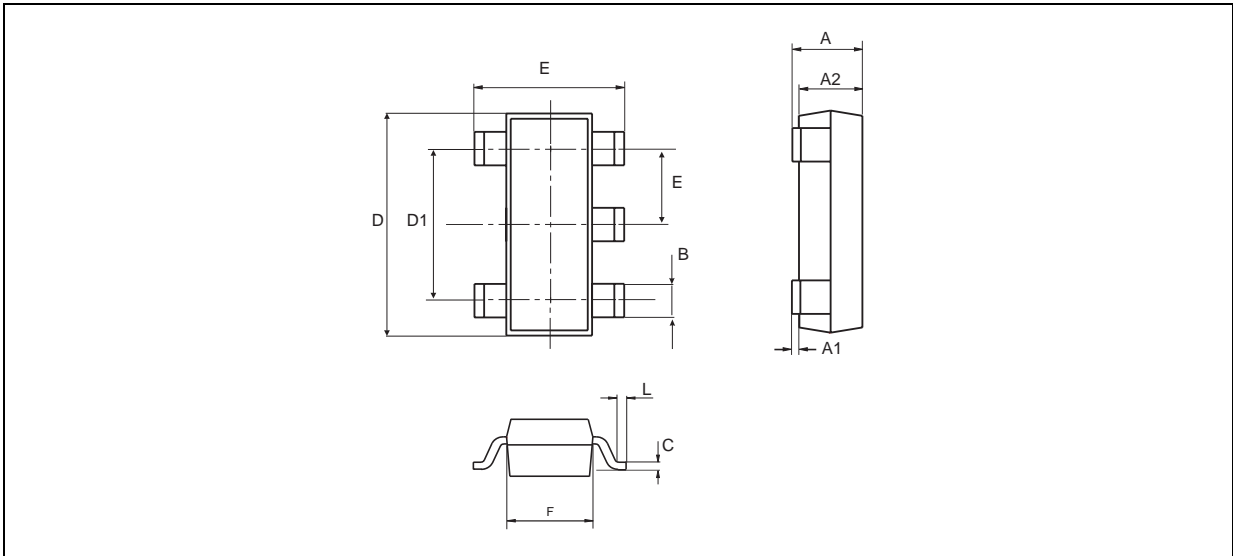

Dimensions	Millimeters			Inches		
	Min.	Typ.	Max.	Min.	Typ.	Max.
A	0.90	1.20	1.45	0.035	0.047	0.057
A1	0		0.15			0.006
A2	0.90	1.05	1.30	0.035	0.041	0.051
B	0.35	0.40	0.50	0.014	0.016	0.020
C	0.09	0.15	0.20	0.004	0.006	0.008
D	2.80	2.90	3.00	0.110	0.114	0.118
D1		1.90			0.075	
e		0.95			0.037	
E	2.60	2.80	3.00	0.102	0.110	0.118
F	1.50	1.60	1.75	0.059	0.063	0.069
L	0.3	0.5	0.60	0.012	0.014	0.024
K	0d		10d	0d		10d

TS1872IST



PACKAGE MECHANICAL DATA
8 PINS - PLASTIC MICROPACKAGE (miniSO)

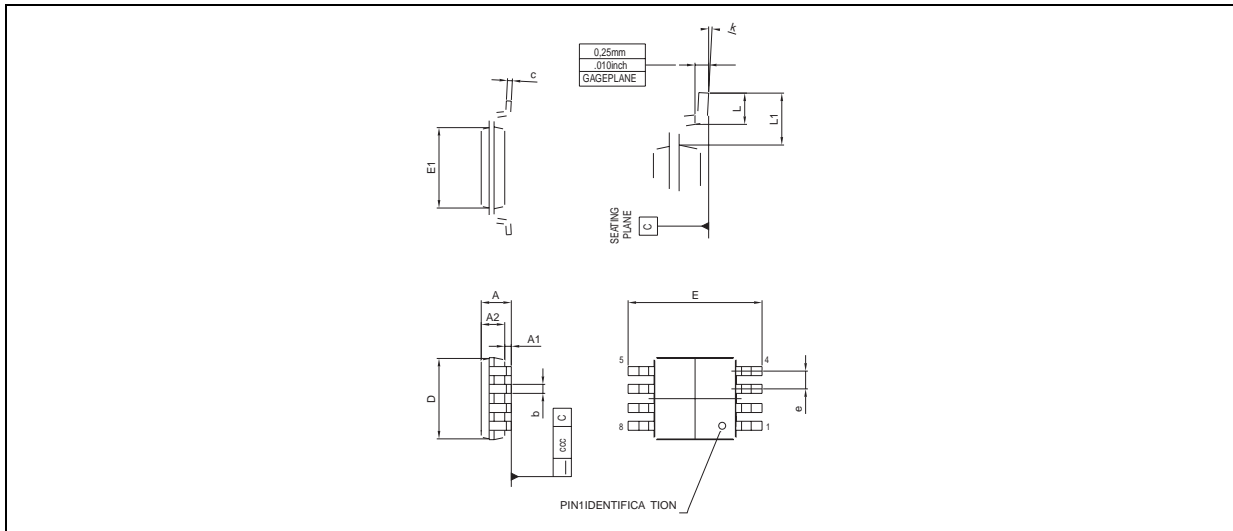

Dimensions	Millimeters			Inches		
	Min.	Typ.	Max.	Min.	Typ.	Max.
A			1.100			0.043
A1	0.050	0.100	0.150	0.002	0.004	0.006
A2	0.780	0.860	0.940	0.031	0.034	0.037
b	0.250	0.330	0.400	0.010	0.013	0.016
c	0.130	0.180	0.230	0.005	0.007	0.009
D	2.900	3.000	3.100	0.114	0.118	0.122
E	4.750	4.900	5.050	0.187	0.193	0.199
E1	2.900	3.000	3.100	0.114	0.118	0.122
e		0.650			0.026	
L	0.400	0.550	0.700	0.016	0.022	0.028
L1		0.950			0.037	
k	0d	3d	6d	0d	3d	6d
aaa			0.100			0.004

Information furnished is believed to be accurate and reliable. However, STMicroelectronics assumes no responsibility for the consequences of use of such information nor for any infringement of patents or other rights of third parties which may result from its use. No license is granted by implication or otherwise under any patent or patent rights of STMicroelectronics. Specifications mentioned in this publication are subject to change without notice. This publication supersedes and replaces all information previously supplied. STMicroelectronics products are not authorized for use as critical components in life support devices or systems without express written approval of STMicroelectronics.

© The ST logo is a registered trademark of STMicroelectronics

© 2002 STMicroelectronics - Printed in Italy - All Rights Reserved
STMicroelectronics GROUP OF COMPANIES

Australia - Brazil - Canada - China - Finland - France - Germany - Hong Kong - India - Israel - Italy - Japan - Malaysia
Malta - Morocco - Singapore - Spain - Sweden - Switzerland - United Kingdom - United States

© <http://www.st.com>

