

DIALIGHT PART NUMBER	LED COLOR	
	POSITION 1	POSITION 2
553-0122-003F	GREEN	GREEN
553-0122-004F	GREEN	GREEN

**RoHS COMPLIANT 553-0122-00XF**  
 Part Numbers with the "F" suffix ending are RoHS Compliant.  
 For example: 553-0122-003F  
 Packaging is marked with "RoHS Compliant" label or equivalent markings. Parts can be wave soldered, dip soldered or hand soldered using typical lead-free soldering process with max 260°C temp. for 5 sec.

REV	ECN NO	REVISIONS	DRN	CKD	APP	DATE
A		NEW RELEASE	AJF	KLJ	NO	12-22-10

**553-0122-004F**

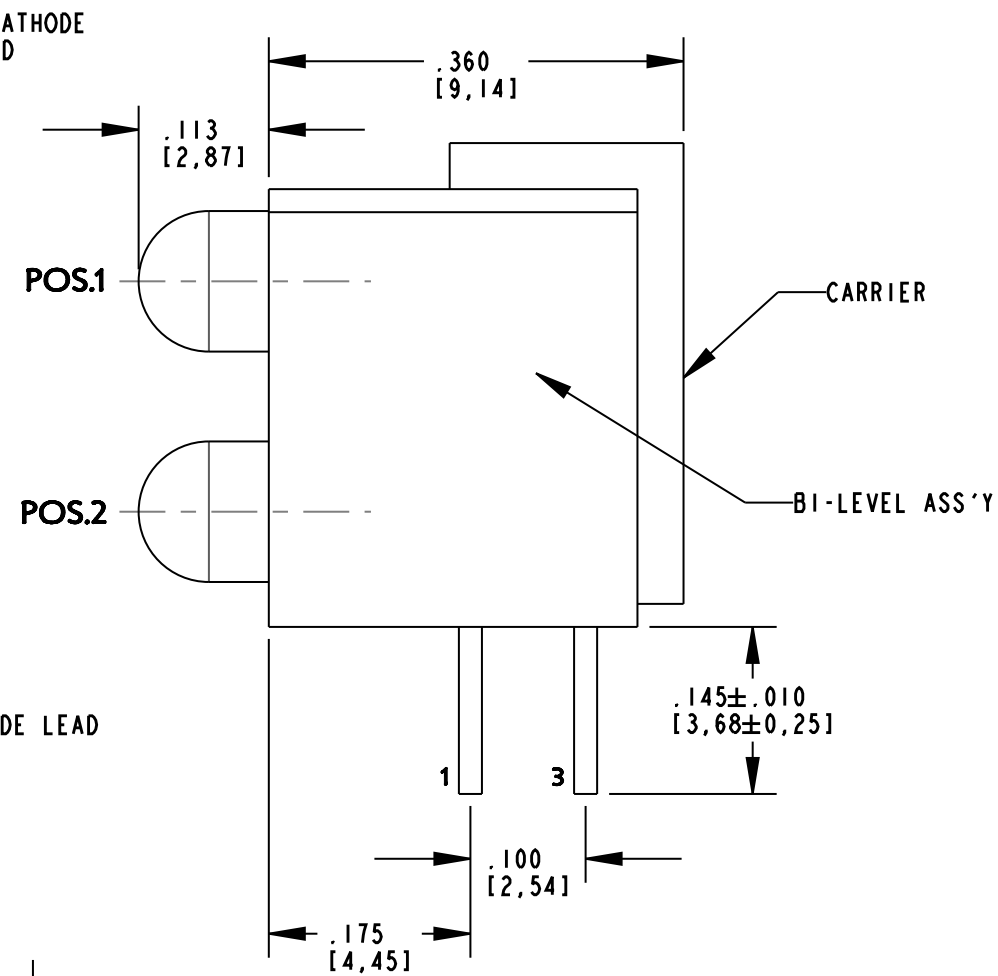
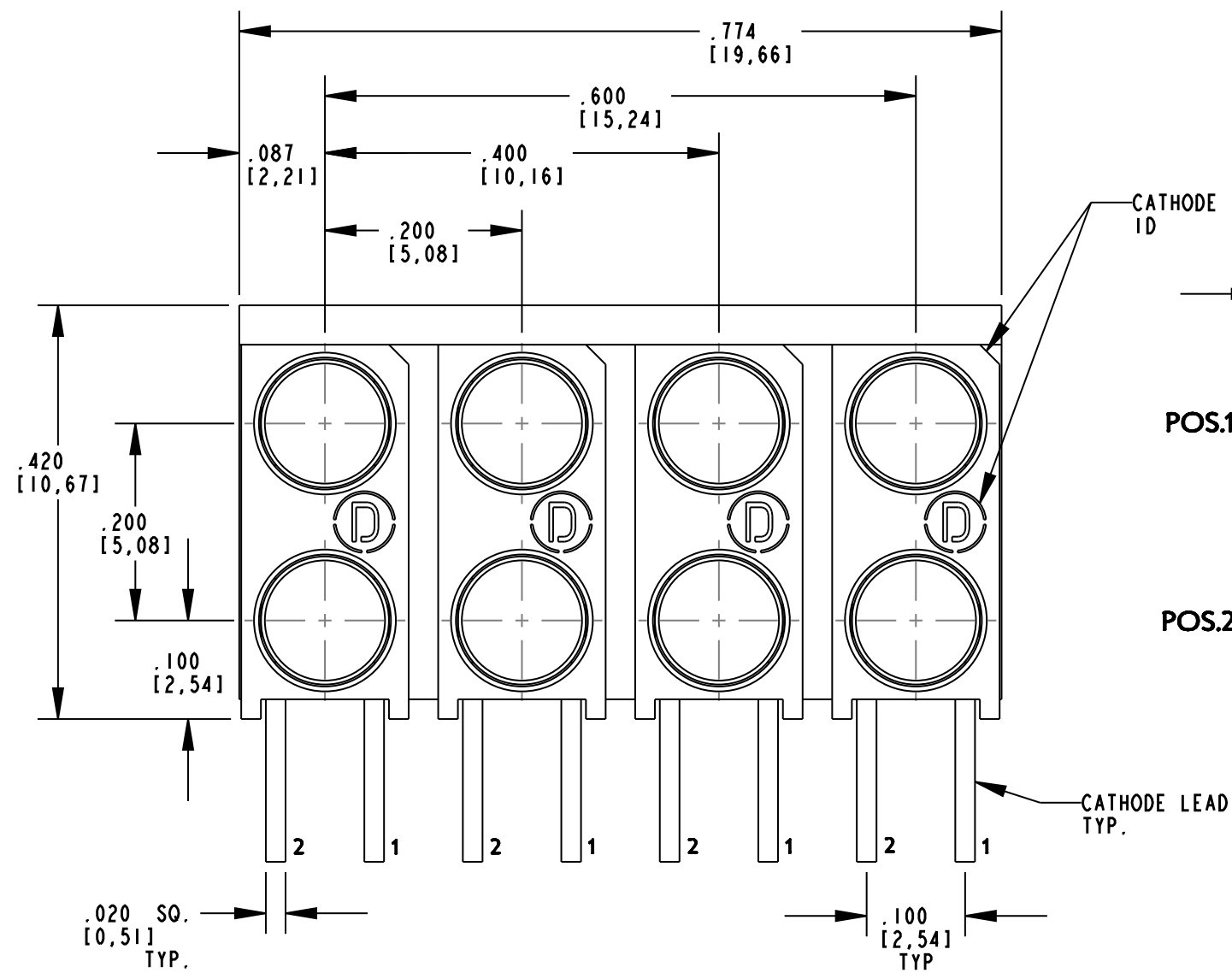

OPERATING CHARACTERISTICS AT 25°C AMBIENT					
LED CHARACTERISTICS	MIN.	TYP.	MAX.	UNITS	TEST CONDITIONS
LUMINOUS INTENSITY	5.6	16.0		mcd	I <sub>f</sub> = 10 mA
PEAK WAVELENGTH		563		nm	
DOMINANT WAVELENGTH	567	572	577	nm	
FORWARD VOLTAGE		2.1	3.0	V	I <sub>f</sub> = 10 mA
REVERSE CURRENT			10	μA	V <sub>r</sub> = 3 V
VIEWING ANGLE		45		DEGREE	

ABSOLUTE MAXIMUM RATINGS AT 25°C AMBIENT		
	VALUE	UNITS
POWER DISSIPATION	75	mW
PEAK FORWARD CURRENT (1/5 DUTY CYCLE, 1ms PULSE WIDTH)	60	mA
CONTINUOUS FORWARD CURRENT	25	mA
LINEAR DERATING FROM 50°C	0.5	mA/°C
REVERSE VOLTAGE	3	V
LEAD SOLDERING TEMPERATURE (.063" [1.6mm] FROM BODY) FOR 5 SEC.	260	°C
OPERATING TEMPERATURE	-25 TO +85	°C
STORAGE TEMPERATURE	-30 TO +100	°C

**553-0122-003F**

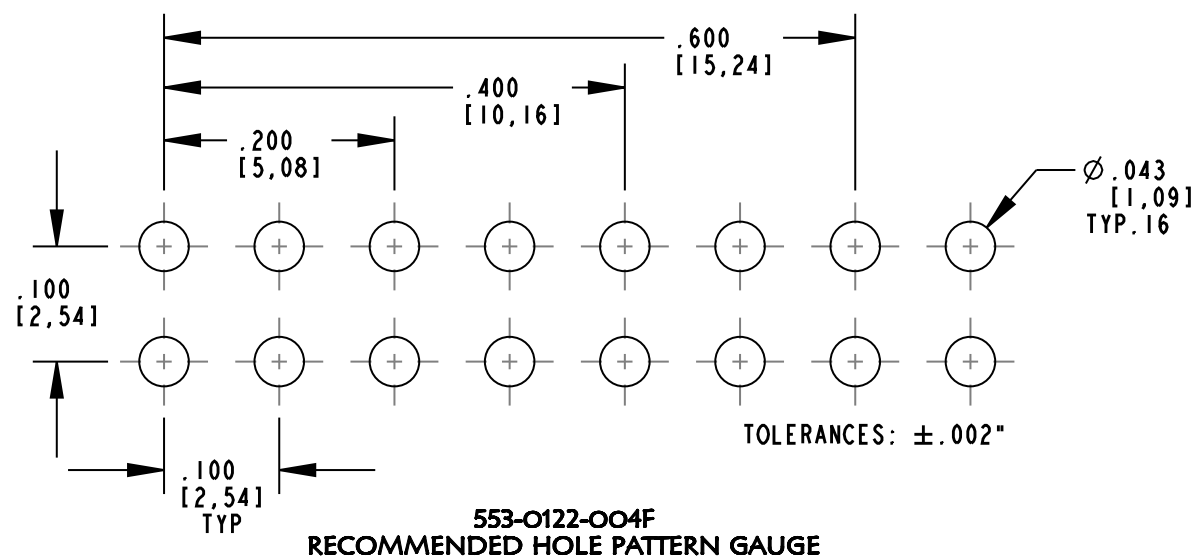
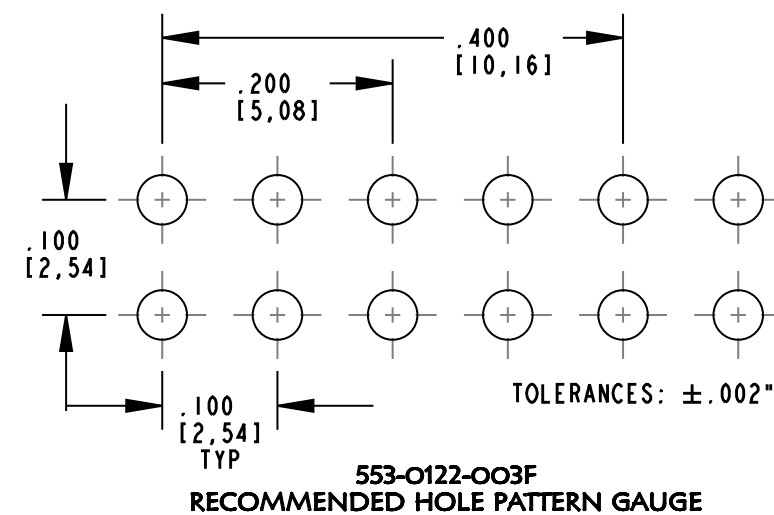
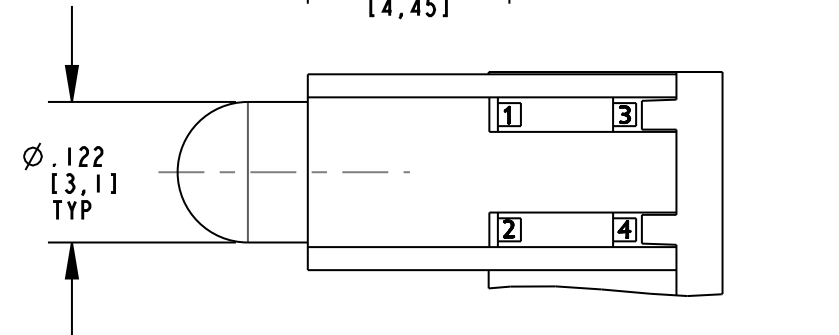
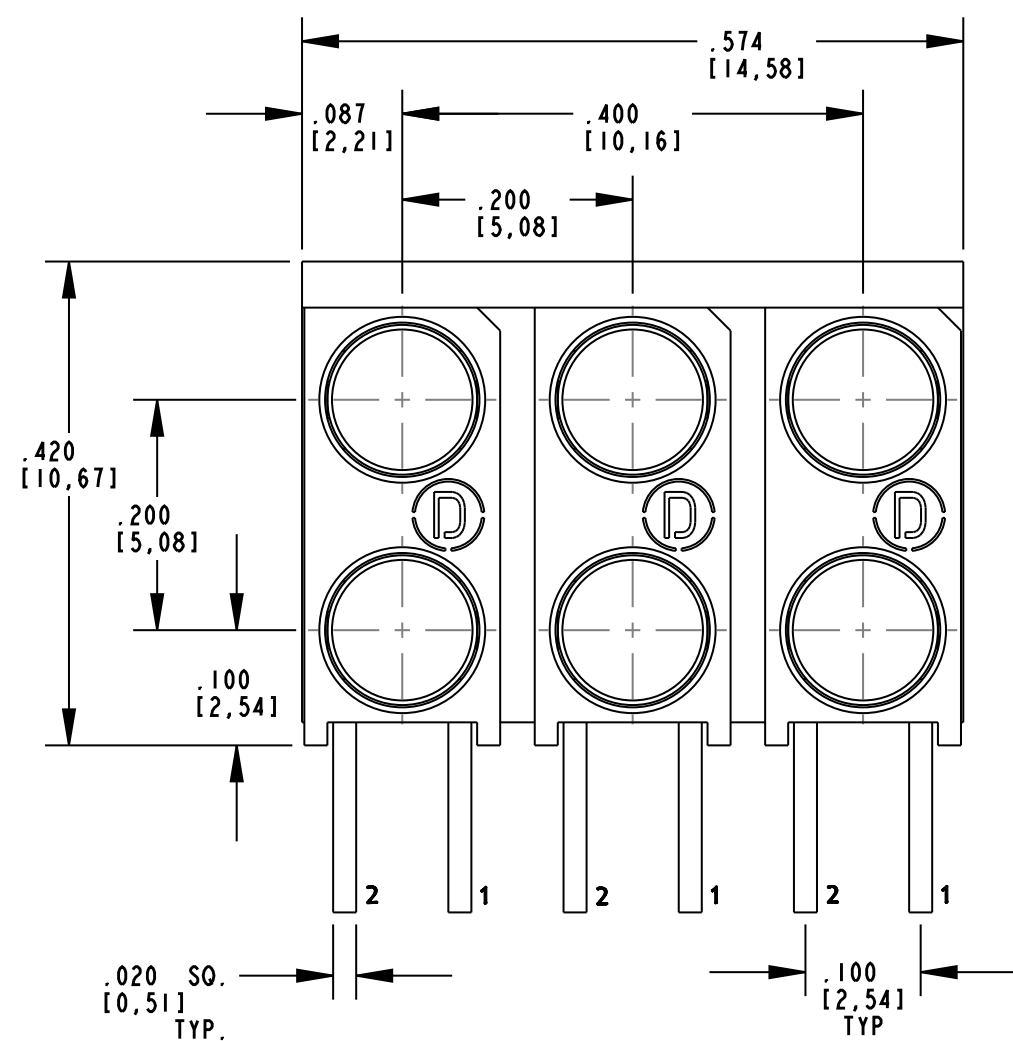

NOTES:

- DIALIGHT PART NUMBERS: 553-0122-00XF.
- LED COLOR: GaP GREEN.
- LED EPOXY: GREEN DIFFUSED.
- LED LEAD DIMENSIONS SHOWN ARE MEASURED AT HOUSING EXIT.
- LEADS TO FIT INTO HOLES SPACED AS PER PATTERN.
- PIN NUMBERS FOR REFERENCE ONLY. DESIGNATION NON-EXISTENT ON PART.
- PARTS TO BE PACKAGED IN TUBE WITH (2) TWO END PLUGS  
 FOR P/N 553-0122-003F: 39 PCS PER TUBE  
 FOR P/N 553-0122-004F: 29 PCS PER TUBE
- THIS ASSEMBLY CONTAINS ELECTROSTATIC DISCHARGE SENSITIVE DEVICES (ESDS). MAINTAIN ALL PRECAUTIONARY MEASURES DURING ASSEMBLY, HANDLING, AND STORAGE IN ACCORDANCE WITH IPC-A-610.

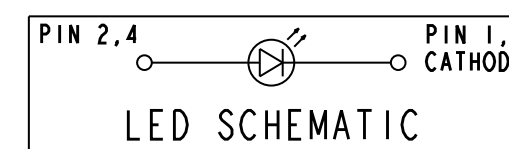

**ATTENTION:**  
 OBSERVE PRECAUTIONS FOR  
 HANDLING ELECTROSTATIC  
 SENSITIVE DEVICES

**553-0122-003F**

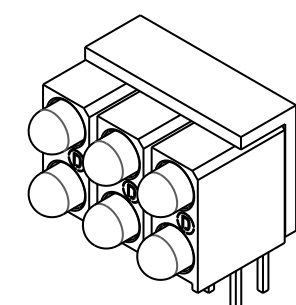

**553-0122-004F**

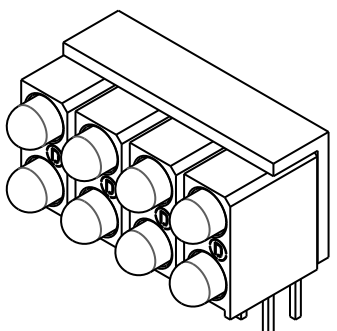

SCALE 2.000

THIS DRAWING AND THE CONTENTS HEREIN ARE CONFIDENTIAL AND THE SOLE PROPERTY OF DIALIGHT. REPRODUCTION OF THIS DRAWING OR CONSTRUCTION OF ANY PARTS WITHIN THIS DRAWING ARE FORBIDDEN WITHOUT THE WRITTEN CONSENT OF DIALIGHT.		
SCALE: 6.000	DRAWING NUMBER	REV
ALL DIM'S IN: INCHES (MM)	C-17896	A
TOLERANCES: UNLESS OTHERWISE SPECIFIED	TITLE GANGED BI-LEVEL CBI ASS'Y	
FRACTIONS: ±1/64	MATERIAL	
DECIMALS (.XX): ±.02	Dialight	
DECIMALS (.XXX): ±.015	1501 ROUTE 34 SOUTH FARMINGDALE, NJ 07727	
ANGLES: ±1°	FSCM 83330	
FINISH:	SHEET 1 OF 1 FAMILY TABLE:	