



Applications

- Input Rectification
- Low Frequency Freewheel
- Battery Isolation

- > Suitable for General Purpose Applications
- > Isolated and Non-Isolated Tab
- > V_R/V_{RRM} 400, 600, 800, 1000V

CRNA/CRNB15

15Amp - 400/600/800/1000V - RECTIFIER

2 Pin Package (Standard)

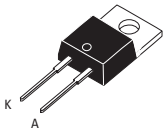

TO-220AB Isolated (CRNA15)

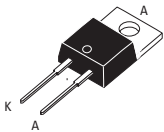

TO-220AB Non-Isolated (CRNB15)

3 Pin Package (Suffix L3)

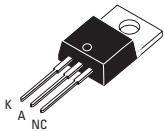

TO-220AB Isolated (CRNA15...L3)

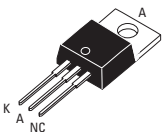

TO-220AB Non-Isolated (CRNB15...L3)



Absolute Maximum Ratings

	CONDITIONS	SYMBOL	RATING
RMS On-State Current (full sine wave)	$T_c = 100^\circ\text{C}$	TO-220AB	$I_{F(RMS)}$ 15A
	$T_c = 90^\circ\text{C}$	TO-220AB Iso	
Average On-State Current	$T_c = 100^\circ\text{C}$	TO-220AB	$I_{F(AV)}$ 9.5A
	$T_c = 90^\circ\text{C}$	TO-220AB Iso	
Non Repetitive Surge Peak On-State Current (Full Cycle, T_j Initial = 25°C)	F = 50 Hz	I_{FSM}	188A
	F = 60 Hz		225A
I^2t Value for fusing	tp = 10 ms	I^2t	210A ² s
Storage Temperature Range		T_{stg}	-40 to +150°C
Operating Junction Temperature Range		T_j	-40 to +125°C
Isolation Voltage (CRNA Series only)		V_{ISO}	2500 V_{RMS}

Electrical Characteristics

V_{FM} @ 15A	$T_j = 25^\circ\text{C}$	1.1V
I_{RM} @ $V_R = V_{RRM}$	$T_j = 25^\circ\text{C}$	0.1mA
I_{RM} @ $V_R = V_{RRM}$	$T_j = 125^\circ\text{C}$	1.0mA

Thermal Resistances

	PACKAGE	SYMBOL	RATING
Junction to Case (AC)	TO-220AB	$R_{th(j-c)}$	1.95°C/W
Junction to Case (AC)	TO-220AB Isolated	$R_{th(j-c)}$	2.85°C/W
Junction to Ambient	TO-220AB	$R_{th(j-a)}$	60°C/W
Junction to Ambient	TO-220AB Isolated	$R_{th(j-a)}$	60°C/W

GENERAL NOTES

1. All parameters at 25 degrees C unless otherwise specified.

Part Number Designation

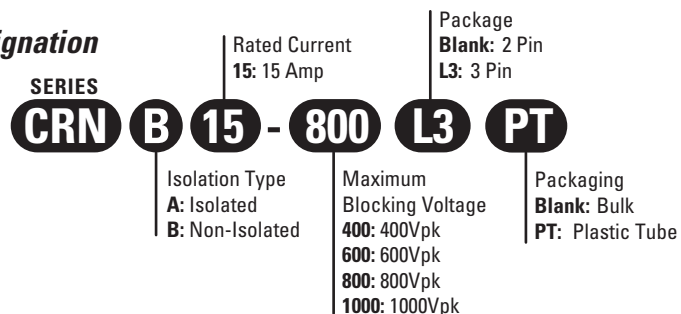

Dimensions 2 Pin Package

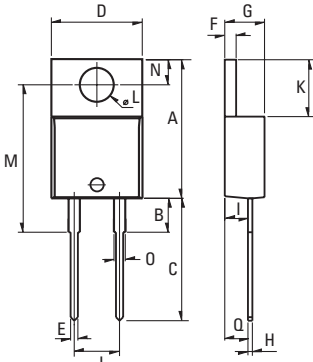

Weight: 2.3g (0.08 oz)

REF.	Millimeters			Inches		
	Min.	Typ.	Max.	Min.	Typ.	Max.
A	15.24		15.75	0.6		0.62
B		3.23			0.127	
C	12.78		13.79	0.503		0.543
D	9.96		10.36	0.392		0.408
E	0.69		0.94	0.027		0.037
F	1.22		1.32	0.048		0.052
G	4.62		4.83	0.182		0.19
H	0.46		0.61	0.018		0.024
I	2.49		2.84	0.098		0.112
J	2.39		2.69	0.094		0.106
K	6.48		6.88	0.255		0.271
L	3.78		3.89	0.149		0.153
M	15.49	16	16.51	0.61	0.63	0.65
N	2.59		2.9	0.102		0.114
O	0.99		1.55	0.039		0.061
Q		2.67			0.105	

Characteristics

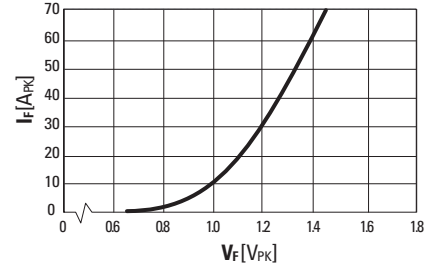

Fig. 1: On-state current versus on-state voltage (instantaneous values)

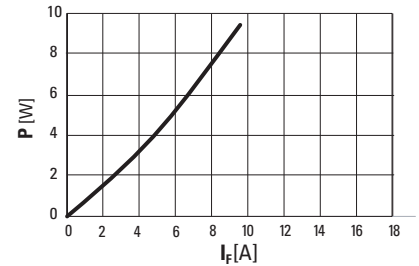
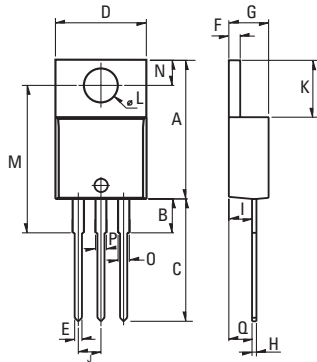

Fig. 3: Power dissipation versus average on-state current

Dimensions 3 Pin Package



Weight: 2.3g (0.08 oz)

REF.	Millimeters			Inches		
	Min.	Typ.	Max.	Min.	Typ.	Max.
A	15.24		15.75	0.6		0.62
B		3.23			0.127	
C	12.78		13.79	0.503		0.543
D	9.96		10.36	0.392		0.408
E	0.69		0.94	0.027		0.037
F	1.22		1.32	0.048		0.052
G	4.62		4.83	0.182		0.19
H	0.46		0.61	0.018		0.024
I	2.49		2.84	0.098		0.112
J	2.39		2.69	0.094		0.106
K	6.48		6.88	0.255		0.271
L	3.78		3.89	0.149		0.153
M	15.49	16	16.51	0.61	0.63	0.65
N	2.59		2.9	0.102		0.114
O	0.99		1.55	0.039		0.061
P	0.99		1.55	0.039		0.061
Q		2.67			0.105	

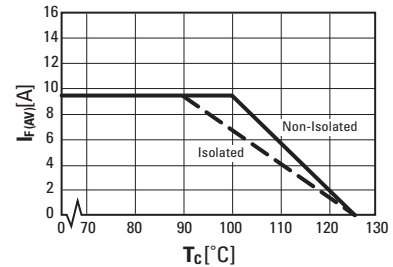

Fig. 2: Average on-state current versus case temperature

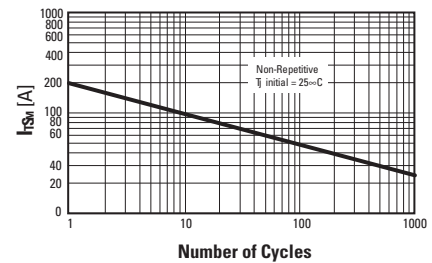

Fig. 4: Non-repetitive surge peak on-state current versus number of cycles.

ISO9001 Certified

Approvals

UL Recognized Component - E72445
(For CRNA series)

USA

Sales Support (877) 502-5500
Tech Support (877) 702-7700
Fax (619) 710-8540
Email: sales@crydom.com
Crydom Corp
2320 Paseo de las Americas, Suite 201
San Diego, CA 92154

EUROPE - UK

Telephone +44 (0) 1202 365070
Fax +44 (0) 1202 365090
Email: intsales@crydom.com
Crydom International Ltd.
7 Cobham Road
Ferndown Industrial Estate
Wimborne, Dorset BH21 7PE

ASIA - Thailand

Telephone +66 (0)2 665 2517
Fax +66 (0)2 665 2588
Crydom Asia
18/8 Fico Place 12th Floor
Soi Sukhumvit 21 (Asoke)
Klongtoey Nua, Wattana
Bangkok, Thailand 10110

Germany

Telephone +49 (0) 180 3000 506