

18.0-21.0/36.0-42.0 GHz GaAs MMIC Doubler and Power Amplifier

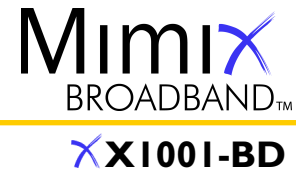

November 2008 - Rev 03-Nov-08

Features

- ✕ Integrated Doubler and Power Amplifier
- ✕ Excellent Saturated Output Stage
- ✕ +26.0 dBm Output Power
- ✕ 50.0 dBc Fundamental Suppression
- ✕ 100% On-Wafer RF, DC and Output Power Testing
- ✕ 100% Commercial-Level Visual Inspection Using Mil-Std-883 Method 2010

General Description

Mimix Broadband's 18.0-21.0/36.0-42.0 GHz GaAs MMIC doubler integrates a doubler and 4-stage power amplifier. The device provides better than +26.0 dBm output power and has excellent fundamental rejection. This MMIC uses Mimix Broadband's GaAs PHEMT device model technology, and is based upon electron beam lithography to ensure high repeatability and uniformity. The chip has surface passivation to protect and provide a rugged part with backside via holes and gold metallization to allow either a conductive epoxy or eutectic solder die attach process. This device is well suited for Millimeter-wave Point-to-Point Radio, LMDS, SATCOM and VSAT applications.

Chip Device Layout

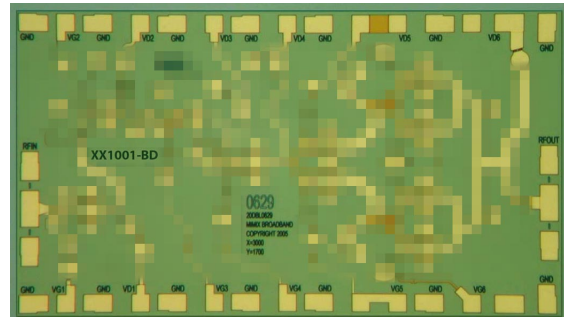

Absolute Maximum Ratings

Supply Voltage (Vd)	+6.0 VDC
Supply Current (Id)	800 mA
Gate Bias Voltage (Vg)	+0.3 VDC
Input Power (RF Pin)	TBD
Storage Temperature (Tstg)	-65 to +165 °C
Operating Temperature (Ta)	-55 to MTTF Table ¹
Channel Temperature (Tch)	MTTF Table ¹

(1) Channel temperature affects a device's MTTF. It is recommended to keep channel temperature as low as possible for maximum life.

Electrical Characteristics (Ambient Temperature T = 25 °C)

Parameter	Units	Min.	Typ.	Max.
Input Frequency Range (fin)	GHz	18.0	-	21.0
Output Frequency Range (fout)	GHz	36.0	-	42.0
Input Return Loss (S11)	dB	-	TBD	-
Output Return Loss (S22)	dB	-	12.0	-
Fundamental Rejection	dBc	-	50.0	-
RF Input Power (RF Pin)	dBm	-	0.0	-
Output Power at 0.0 dBm Pin (Pout)	dBm	-	+26.0	-
Drain Supply Voltage (Vd1) Doubler	V	-	2.5	3.0
Drain Supply Voltage (Vd2) Buffer Amp	V	-	3.0	4.0
Drain Supply Voltage (Vd3,4,5,6) PA	V	-	4.5	5.5
Gate Supply Voltage (Vg1) Doubler	V	-	-1.2	-
Drain Supply Current (Id1) Doubler	mA	-	<1.0	-
Drain Supply Current (Id2) Buffer	mA	-	20	25
Drain Supply Current (Id3,4,5,6) (Vg=-0.7V Typical) PA	mA	-	530	600

18.0-21.0/36.0-42.0 GHz GaAs MMIC Doubler and Power Amplifier

Power Amplifier Measurements

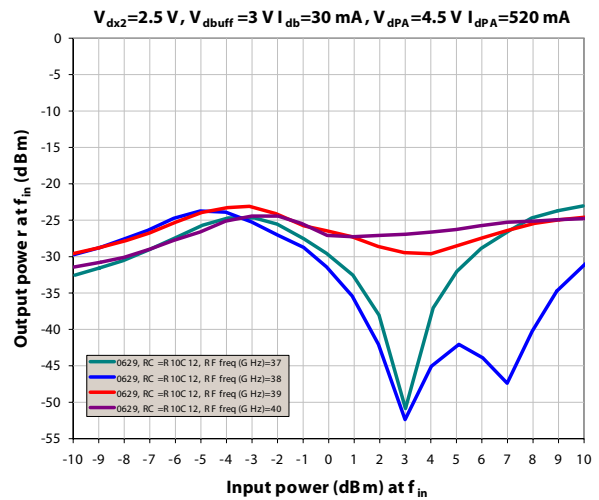
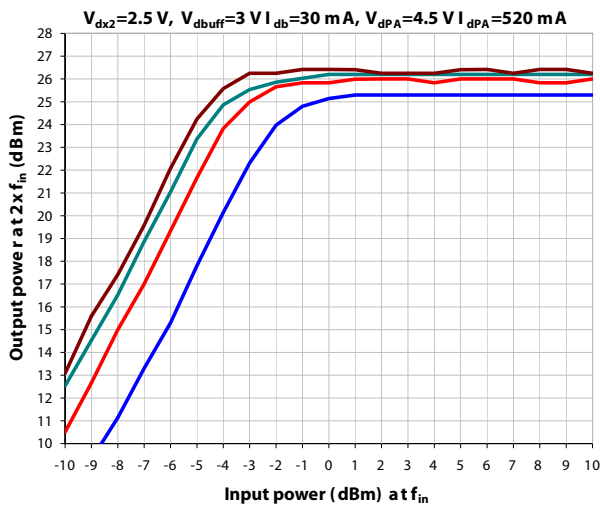
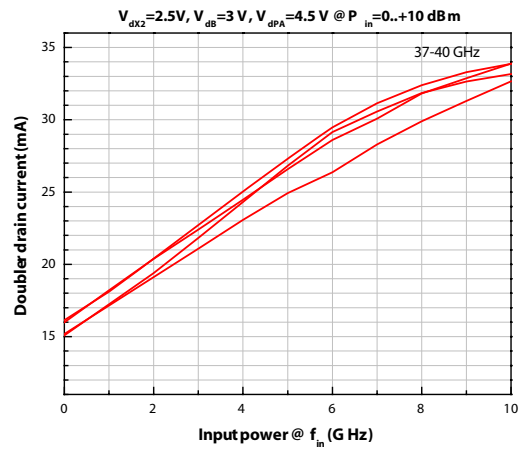
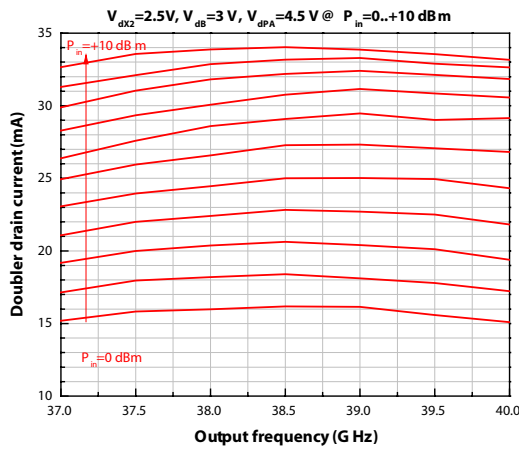
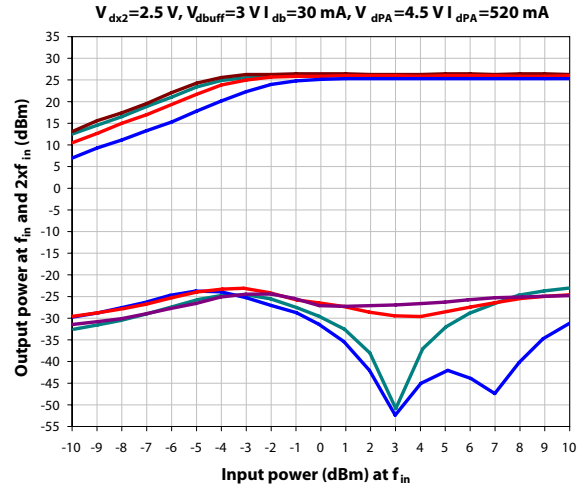
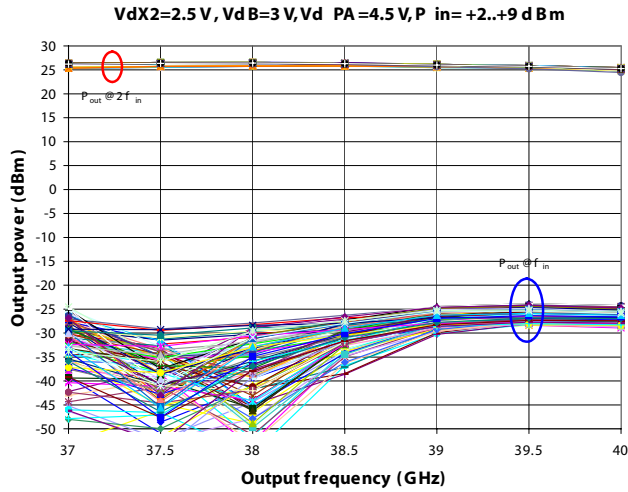

18.0-21.0/36.0-42.0 GHz GaAs MMIC Doubler and Power Amplifier

Mechanical Drawing

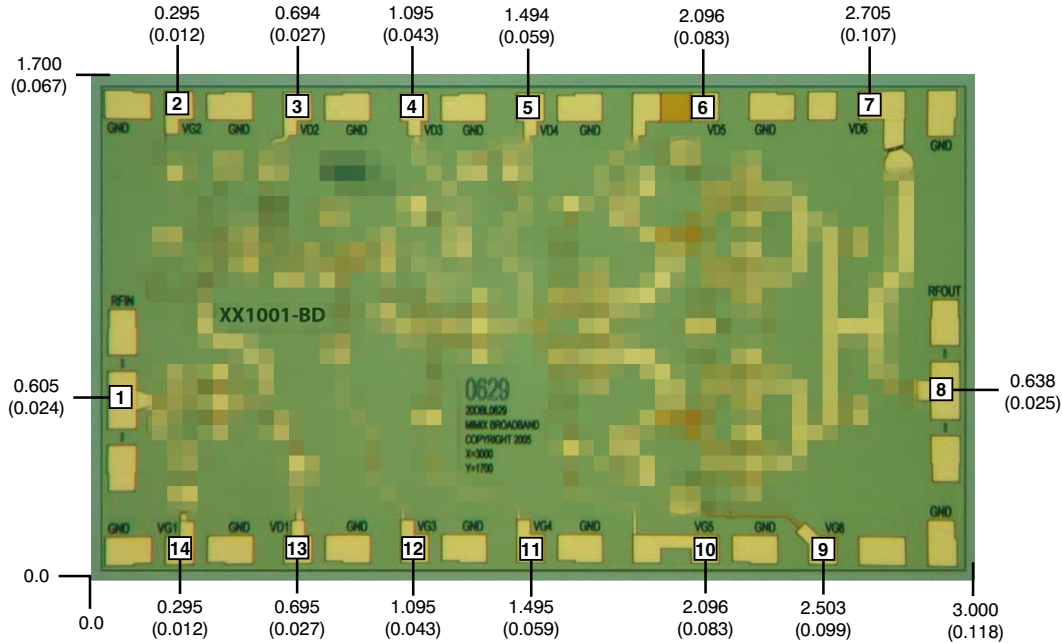

(Note: Engineering designator is 20DBL0629)

Units: millimeters (inches) Bond pad dimensions are shown to center of bond pad.
 Thickness: 0.110 +/- 0.010 (0.0043 +/- 0.0004), Backside is ground, Bond Pad/Backside Metallization: Gold
 All DC Bond Pads are 0.100 x 0.100 (0.004 x 0.004). All RF Bond Pads are 0.100 x 0.200 (0.004 x 0.008)
 Bond pad centers are approximately 0.109 (0.004) from the edge of the chip.
 Dicing tolerance: +/- 0.005 (+/- 0.0002). Approximate weight: 3.987 mg.

- | | | | |
|---------------------|----------------------|--------------------|--------------------|
| Bond Pad #1 (RF In) | Bond Pad #5 (Vd4) | Bond Pad #9 (Vg6) | Bond Pad #13 (Vd1) |
| Bond Pad #2 (Vg2) | Bond Pad #6 (Vd5) | Bond Pad #10 (Vg5) | Bond Pad #14 (Vg1) |
| Bond Pad #3 (Vd2) | Bond Pad #7 (Vd6) | Bond Pad #11 (Vg4) | |
| Bond Pad #4 (Vd3) | Bond Pad #8 (RF Out) | Bond Pad #12 (Vg3) | |

Bias Arrangement

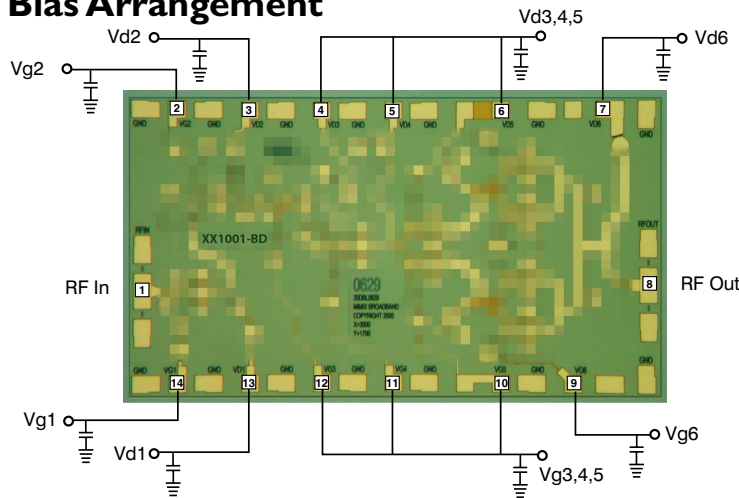

Bypass Capacitors - See App Note [2]

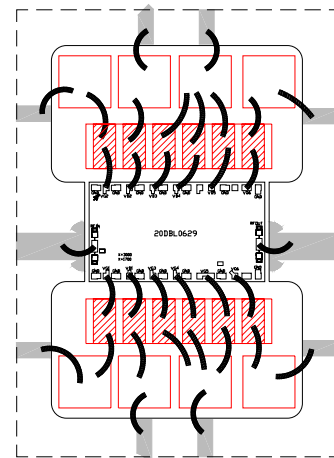

18.0-21.0/36.0-42.0 GHz GaAs MMIC Doublers and Power Amplifier

November 2008 - Rev 03-Nov-08

App Note [1] Biasing - It is recommended to separately bias each amplifier stage Vd1 through Vd6 at Vd1=2.5V, Vd2=3.0V, Vd(3,4,5,6)=4.5V with Id1<1mA, Id2=20mA, Id3=40mA, Id4=70mA, Id5=150mA, Id6=270mA. Separate biasing is recommended if the amplifier is to be used at high levels of saturation, where gate rectification will alter the effective gate control voltage. As shown in the bonding diagram, it is possible to parallel stages Vd(3,4,5) with Id(3,4,5)=260mA while maintaining satisfactory performance. For non-critical applications it is possible to parallel stages Vd(3,4,5,6) together and adjust the common gate voltage Vg(3,4,5,6) for total drain current Id(total)=530mA. It is also recommended to use active biasing to keep the currents constant as the RF power and temperature vary; this gives the most reproducible results. Depending on the supply voltage available and the power dissipation constraints, the bias circuit may be a single transistor or a low power operational amplifier, with a low value resistor in series with the drain supply used to sense the current. The gate of the pHEMT is controlled to maintain correct drain current and thus drain voltage. The typical gate voltage needed to do this is -0.7V. Typically the gate is protected with Silicon diodes to limit the applied voltage. Also, make sure to sequence the applied voltage to ensure negative gate bias is available before applying the positive drain supply.

App Note [2] Bias Arrangement -

For Parallel Stage Bias (Recommended for general applications) -- The same as Individual Stage Bias but all the drain pad DC bypass capacitors (~100-200 pF) can be combined. Additional DC bypass capacitance (~0.01 uF) is also recommended to all DC or combination (if gate or drains are tied together) of DC bias pads. Vd(3,4,5,6) or Vg(3,4,5,6) have been tied together but can be left open.

For Individual Stage Bias (Recommended for saturated applications) -- Each DC pad (Vd1,2,3,4,5,6 and Vg1,2,3,4,5,6) needs to have DC bypass capacitance (~100-200 pF) as close to the device as possible. Additional DC bypass capacitance (~0.01 uF) is also recommended.

MTTF

MTTF is calculated from accelerated life-time data of single devices and assumes an isothermal back-plate.

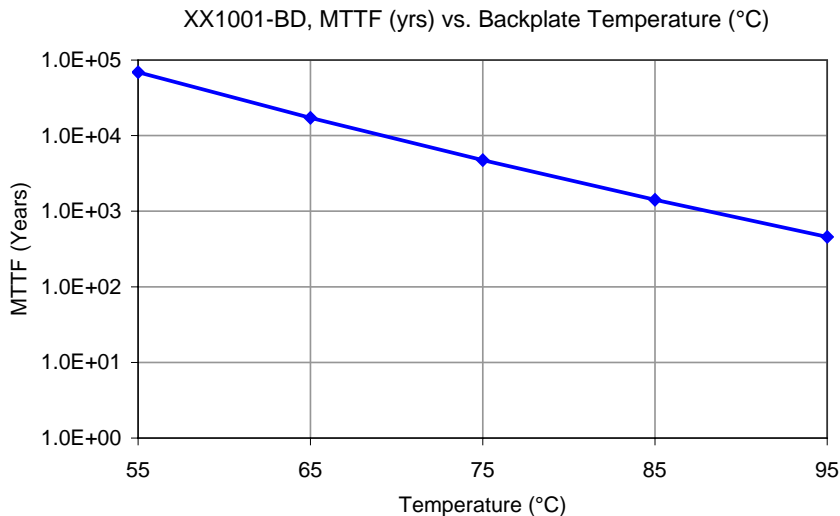

18.0-21.0/36.0-42.0 GHz GaAs MMIC Doubler and Power Amplifier

Device Schematic

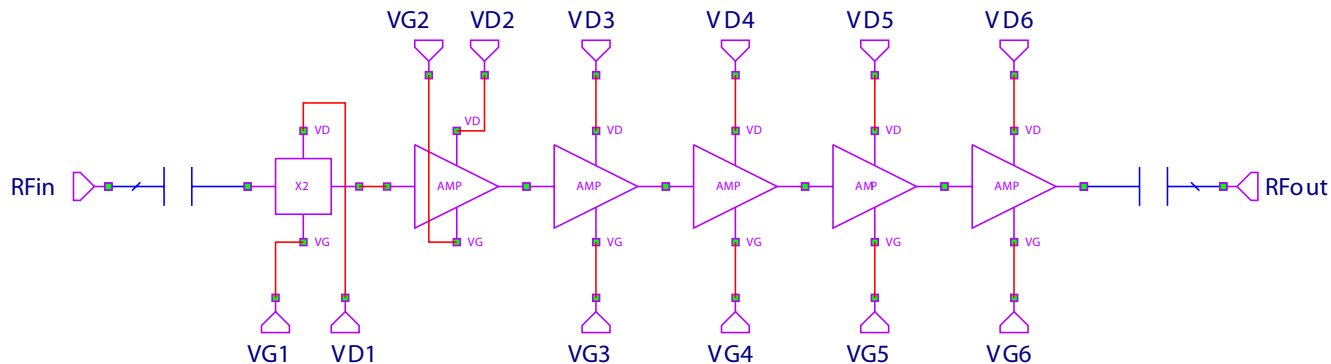

18.0-21.0/36.0-42.0 GHz GaAs MMIC Doublers and Power Amplifier

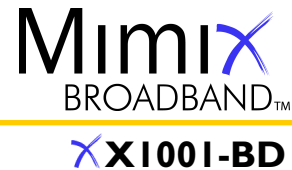

November 2008 - Rev 03-Nov-08

Handling and Assembly Information

CAUTION! - Mimix Broadband MMIC Products contain gallium arsenide (GaAs) which can be hazardous to the human body and the environment. For safety, observe the following procedures:

- Do not ingest.
- Do not alter the form of this product into a gas, powder, or liquid through burning, crushing, or chemical processing as these by-products are dangerous to the human body if inhaled, ingested, or swallowed.
- Observe government laws and company regulations when discarding this product. This product must be discarded in accordance with methods specified by applicable hazardous waste procedures.

Life Support Policy - Mimix Broadband's products are not authorized for use as critical components in life support devices or systems without the express written approval of the President and General Counsel of Mimix Broadband. As used herein: (1) Life support devices or systems are devices or systems which, (a) are intended for surgical implant into the body, or (b) support or sustain life, and whose failure to perform when properly used in accordance with instructions for use provided in the labeling, can be reasonably expected to result in a significant injury to the user. (2) A critical component is any component of a life support device or system whose failure to perform can be reasonably expected to cause the failure of the life support device or system, or to affect its safety or effectiveness.

ESD - Gallium Arsenide (GaAs) devices are susceptible to electrostatic and mechanical damage. Die are supplied in antistatic containers, which should be opened in cleanroom conditions at an appropriately grounded anti-static workstation. Devices need careful handling using correctly designed collets, vacuum pickups or, with care, sharp tweezers.

Die Attachment - GaAs Products from Mimix Broadband are 0.100 mm (0.004") thick and have vias through to the backside to enable grounding to the circuit. Microstrip substrates should be brought as close to the die as possible. The mounting surface should be clean and flat. If using conductive epoxy, recommended epoxies are Tanaka TS3332LD, Die Mat DM6030HK or DM6030HK-Pt cured in a nitrogen atmosphere per manufacturer's cure schedule. Apply epoxy sparingly to avoid getting any on to the top surface of the die. An epoxy fillet should be visible around the total die periphery. For additional information please see the Mimix "Epoxy Specifications for Bare Die" application note. If eutectic mounting is preferred, then a fluxless gold-tin (AuSn) preform, approximately 0.001" thick, placed between the die and the attachment surface should be used. A die bonder that utilizes a heated collet and provides scrubbing action to ensure total wetting to prevent void formation in a nitrogen atmosphere is recommended. The gold-tin eutectic (80% Au 20% Sn) has a melting point of approximately 280° C (Note: Gold Germanium should be avoided). The work station temperature should be 310° C +/- 10° C. Exposure to these extreme temperatures should be kept to minimum. The collet should be heated, and the die pre-heated to avoid excessive thermal shock. Avoidance of air bridges and force impact are critical during placement.

Wire Bonding - Windows in the surface passivation above the bond pads are provided to allow wire bonding to the die's gold bond pads. The recommended wire bonding procedure uses 0.076 mm x 0.013 mm (0.003" x 0.0005") 99.99% pure gold ribbon with 0.5-2% elongation to minimize RF port bond inductance. Gold 0.025 mm (0.001") diameter wedge or ball bonds are acceptable for DC Bias connections. Aluminum wire should be avoided. Thermo-compression bonding is recommended though thermosonic bonding may be used providing the ultrasonic content of the bond is minimized. Bond force, time and ultrasonics are all critical parameters. Bonds should be made from the bond pads on the die to the package or substrate. All bonds should be as short as possible.

Ordering Information

Part Number for Ordering	Description
XX1001-BD-000V	"V" - vacuum release gel paks
XX1001-BD-EV1	XX1001 die evaluation module



Caution: ESD Sensitive
Appropriate precautions in handling, packaging
and testing devices must be observed.

Proper ESD procedures should be followed when handling this device.

Mimix Broadband, Inc., 10795 Rockley Rd., Houston, Texas 77099
Tel: 281.988.4600 Fax: 281.988.4615 mimixbroadband.com

Page 6 of 6