

TOSHIBA CMOS DIGITAL INTEGRATED CIRCUIT SILICON MONOLITHIC

TC4W53F, TC4W53FU

2-CHANNEL MULTIPLEXER / DEMULTIPLEXER

The TC4W53 is multiplexer with capabilities of selection and mixture of analog signal and digital signal. TC4W53F has 2 channel configuration. The digital signal to the control terminal turns "ON" the corresponding switch of each channel, with large amplitude ($V_{DD}-V_{EE}$) can be switched by the control signal with small logical amplitude ($V_{DD}-V_{SS}$). For example, in the case of $V_{DD}=5V$, $V_{SS}=0V$ and $V_{EE}=-5V$, signals between $-5V$ and $+5V$ can be switched from the logical circuit with signal power supply of 5 volts. As the ON-resistance of each switch is low, these can be connected to the circuits with low input impedance.

MAXIMUM RATINGS

CHARACTERISTIC	SYMBOL	RATING	UNIT
DC Supply Voltage	$V_{DD}-V_{SS}$	$-0.5\sim 20$	V
DC Supply Voltage	$V_{DD}-V_{EE}$	$-0.5\sim 20$	V
Control Input Voltage	V_{CIN}	$V_{SS}-0.5\sim V_{DD}+0.5$	V
Switch I/O Voltage	V_I/V_O	$V_{EE}-0.5\sim V_{DD}+0.5$	V
Control Input Current	I_{CIN}	± 10	mA
Potential difference across I/O during ON	V_{I-O}	$-0.5\sim 0.5$	V
Power Dissipation	P_D	300	mW
Operating Temperature	T_{opr}	$-40\sim 85$	$^{\circ}C$
Storage Temperature	T_{stg}	$-65\sim 150$	$^{\circ}C$
Lead Temperature (10s)	T_L	260	$^{\circ}C$

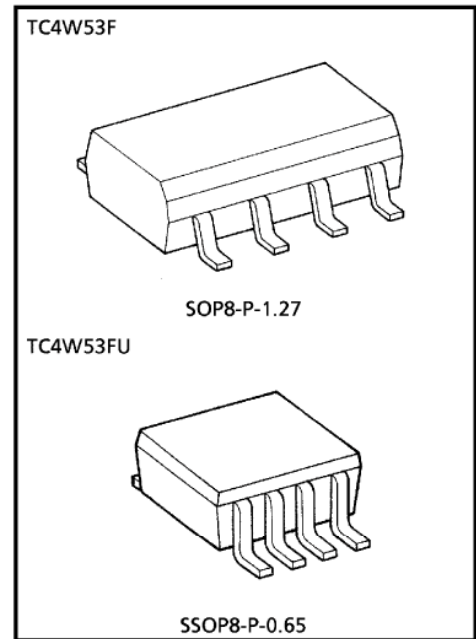

Weight SOP8-P-1.27 : 0.05g (Typ.)
SSOP8-P-0.65 : 0.02g (Typ.)

MARKING

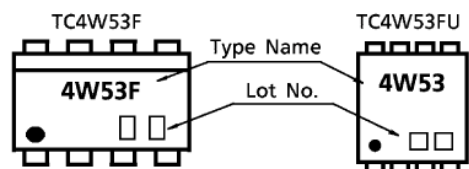

LOGIC DIAGRAM

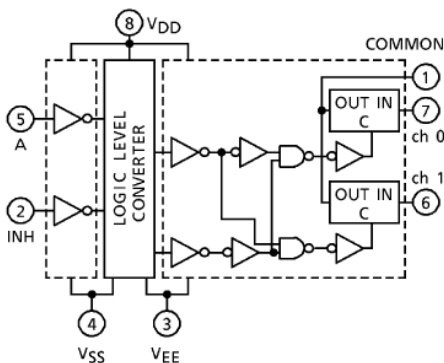

TRUTH TABLE

CONTROL INPUT		ON CHANNEL
INH	A	
L	L	ch 0
L	H	ch 1
H	x	NONE

x : Don't Care



TRUTH TABLE

CONTROL C	IMPE-DANCE BETWEEN IN-OUT
H	$0.5\sim 5 \times 10^2 \Omega$
L	$> 10^9 \Omega$

PIN ASSIGNMENT (TOP VIEW)

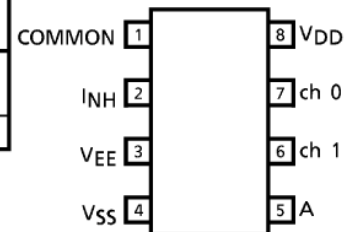

RECOMMENDED OPERATING CONDITIONS

CHARACTERISTIC	SYMBOL		MIN.	TYP.	MAX.	UNIT
DC Supply Voltage	$V_{DD}-V_{SS}$	—	3	—	18	V
	$V_{DD}-V_{EE}$	—	3	—	18	V
Control Input Voltage	V_{IN}	—	V_{SS}	—	V_{DD}	V
Input / Output Voltage	$V_{IN}-V_{OUT}$	—	V_{EE}	—	V_{DD}	V

DC ELECTRICAL CHARACTERISTICS

CHARACTERISTIC	SYM-BOL	TEST CONDITION			-40°C		25°C			85°C		UNIT	
		V_{SS} (V)	V_{EE} (V)	V_{DD} (V)	MIN.	MAX.	MIN.	TYP.	MAX.	MIN.	MAX.		
Control Input High Voltage	V_{IH}	$V_{IS} = V_{DD}$ thru $1k\Omega$	$V_{EE} = V_{SS}$ $R_L = 1k\Omega$ to V_{SS} $I_{LS} < 2\mu A$ on all OFF Channels	5	3.5	—	3.5	2.75	—	3.5	—	V	
				10	7.0	—	7.0	5.50	—	7.0	—		
				15	11.0	—	11.0	8.25	—	11.0	—		
Control Input Low Voltage	V_{IL}			5	—	1.5	—	2.25	1.5	—	1.5	V	
				10	—	3.0	—	4.5	3.0	—	3.0		
				15	—	4.0	—	6.75	4.0	—	4.0		
On-State Resistance	R_{ON}	$0 \leq V_{IS} \leq V_{DD}$ $R_L = 10k\Omega$	0	0	5	—	850	—	240	950	—	1200	Ω
			0	0	10	—	210	—	110	250	—	300	
			0	0	15	—	140	—	80	160	—	200	
Δ ON-State Resistance Between 2 Switches	ΔR_{ON}	—		5	—	—	—	10	—	—	—	Ω	
				10	—	—	—	6	—	—	—		
				15	—	—	—	4	—	—	—		
Input / Output Leakage Current	I_{OFF}	$V_{IN} = 18V, V_{OUT} = 0V$ $V_{IN} = 0V, V_{OUT} = 18V$	18	—	± 100	—	± 0.01	± 100	—	± 1000	—	nA	
			18	—	± 100	—	± 0.01	± 100	—	± 1000			
Quiescent Device Current	I_{DD}	$V_{IN} = V_{SS}, V_{DD} *$	5	—	5.0	—	0.005	5.0	—	150	μA		
			10	—	10	—	0.010	10	—	300			
			15	—	20	—	0.015	20	—	600			
Input Current	I_{IN}	$V_{IH} = 18V, V_{IL} = 0V$	18	—	0.1	—	10^{-5}	0.1	—	1.0	μA		
			18	—	-0.1	—	-10^{-5}	-0.1	—	-1.0			
Input Capacitance	C_{IN}	—	—	—	—	—	5	7.5	—	—	pF		
Switch Input Capacitance	C_{IN}	—	—	—	—	—	10	—	—	—	pF		
Switch Output Capacitance	C_{OUT}	—	—	10	—	—	17	—	—	—			
Feedthrough Capacitance	C_{IN}^- C_{OUT}	—	—	10	—	—	0.2	—	—	—			

* All valid input combinations.

AC ELECTRICAL CHARACTERISTICS (Ta = 25°C, CL = 50pF)

CHARACTERISTIC	SYMBOL	TEST CONDITION	TEST CONDITION			MIN.	TYP.	MAX.	UNIT
			VSS (V)	VEE (V)	VDD (V)				
Phase difference between input to output	ϕI-O	—	0	0	5	—	15	45	ns
			0	0	10	—	8	20	
			0	0	15	—	6	15	
Propagation Delay Time (A-OUT)	t _{pZL} t _{pZH} t _{pLZ} t _{pHZ}	R _L = 1kΩ	0	0	5	—	170	550	ns
			0	0	10	—	90	240	
			0	0	15	—	70	160	
			0	-5	5	—	100	240	
			0	-7.5	7.5	—	80	160	
Propagation Delay Time (INH-OUT)	t _{pZL} t _{pZH}	R _L = 1kΩ	0	0	5	—	120	380	ns
			0	0	10	—	60	200	
			0	0	15	—	50	160	
			0	-5	5	—	80	200	
			0	-7.5	7.5	—	60	160	
Propagation Delay Time (INH-OUT)	t _{pLZ} t _{pHZ}	R _L = 1kΩ	0	0	5	—	170	450	ns
			0	0	10	—	90	210	
			0	0	15	—	70	160	
			0	-5	5	—	100	210	
			0	-7.5	7.5	—	80	160	
-3dB Cutoff Frequency	f _{MAX} (I-O)	R _L = 1kΩ (*1)	-5	-5	5	—	40	—	MHz
Total Harmonic Distortion	—	R _L = 10kΩ (*2) f = 1kHz	-2.5	-2.5	2.5	—	0.15	—	%
			-5	-5	5	—	0.03	—	
			-7.5	-7.5	7.5	—	0.02	—	
-50dB Feedthrough (Switch OFF)	—	R _L = 1kΩ (*3)	-5	-5	5	—	500	—	kHz
Crosstalk (CONTROL-OUT)	—	R _{IN} = 1kΩ R _{OUT} = 10kΩ C _L = 15pF	0	0	5	—	200	—	mV
			0	0	10	—	400	—	
			0	0	15	—	600	—	

*1 Sine wave of ±2.5V_{p-p} shall be used for V_{IS} and the frequency of $20\log_{10} \frac{V_{OS}}{V_{IS}}$ = -3dB shall be f_{MAX}.

*2 V_{IS} shall be sine wave of $\pm \left(\frac{V_{DD} - V_{EE}}{4} \right)$ p-p.

*3 Sine wave of ±2.5V_{p-p} shall be used for V_{IS} and the frequency of $20\log_{10} \frac{V_{OS}}{V_{IS}}$ = -50dB shall be feed-through.

PACKAGE DIMENSIONS
SOP8-P-1.27

Unit : mm

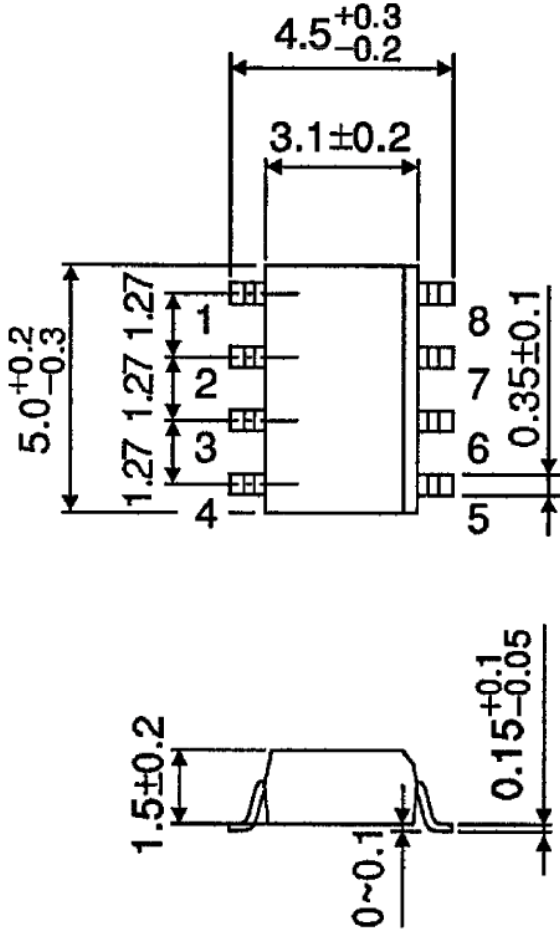

Weight : 0.05g (Typ.)

PACKAGE DIMENSIONS
SSOP8-P-0.65

Unit : mm

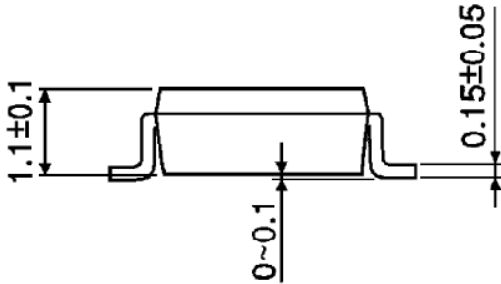
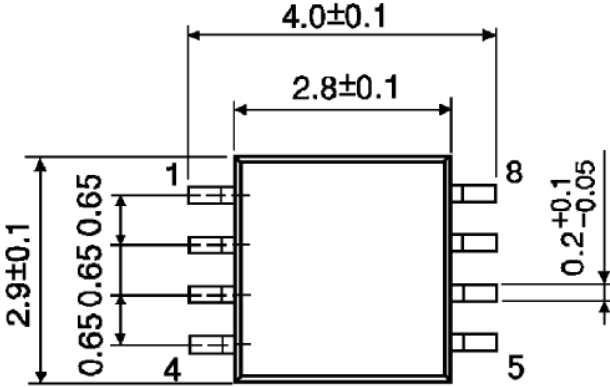

Weight : 0.02g (Typ.)

RESTRICTIONS ON PRODUCT USE

- Toshiba Corporation, and its subsidiaries and affiliates (collectively "TOSHIBA"), reserve the right to make changes to the information in this document, and related hardware, software and systems (collectively "Product") without notice.
- This document and any information herein may not be reproduced without prior written permission from TOSHIBA. Even with TOSHIBA's written permission, reproduction is permissible only if reproduction is without alteration/omission.
- Though TOSHIBA works continually to improve Product's quality and reliability, Product can malfunction or fail. Customers are responsible for complying with safety standards and for providing adequate designs and safeguards for their hardware, software and systems which minimize risk and avoid situations in which a malfunction or failure of Product could cause loss of human life, bodily injury or damage to property, including data loss or corruption. Before customers use the Product, create designs including the Product, or incorporate the Product into their own applications, customers must also refer to and comply with (a) the latest versions of all relevant TOSHIBA information, including without limitation, this document, the specifications, the data sheets and application notes for Product and the precautions and conditions set forth in the "TOSHIBA Semiconductor Reliability Handbook" and (b) the instructions for the application with which the Product will be used with or for. Customers are solely responsible for all aspects of their own product design or applications, including but not limited to (a) determining the appropriateness of the use of this Product in such design or applications; (b) evaluating and determining the applicability of any information contained in this document, or in charts, diagrams, programs, algorithms, sample application circuits, or any other referenced documents; and (c) validating all operating parameters for such designs and applications. **TOSHIBA ASSUMES NO LIABILITY FOR CUSTOMERS' PRODUCT DESIGN OR APPLICATIONS.**
- Product is intended for use in general electronics applications (e.g., computers, personal equipment, office equipment, measuring equipment, industrial robots and home electronics appliances) or for specific applications as expressly stated in this document. Product is neither intended nor warranted for use in equipment or systems that require extraordinarily high levels of quality and/or reliability and/or a malfunction or failure of which may cause loss of human life, bodily injury, serious property damage or serious public impact ("Unintended Use"). Unintended Use includes, without limitation, equipment used in nuclear facilities, equipment used in the aerospace industry, medical equipment, equipment used for automobiles, trains, ships and other transportation, traffic signaling equipment, equipment used to control combustions or explosions, safety devices, elevators and escalators, devices related to electric power, and equipment used in finance-related fields. Do not use Product for Unintended Use unless specifically permitted in this document.
- Do not disassemble, analyze, reverse-engineer, alter, modify, translate or copy Product, whether in whole or in part.
- Product shall not be used for or incorporated into any products or systems whose manufacture, use, or sale is prohibited under any applicable laws or regulations.
- The information contained herein is presented only as guidance for Product use. No responsibility is assumed by TOSHIBA for any infringement of patents or any other intellectual property rights of third parties that may result from the use of Product. No license to any intellectual property right is granted by this document, whether express or implied, by estoppel or otherwise.
- **ABSENT A WRITTEN SIGNED AGREEMENT, EXCEPT AS PROVIDED IN THE RELEVANT TERMS AND CONDITIONS OF SALE FOR PRODUCT, AND TO THE MAXIMUM EXTENT ALLOWABLE BY LAW, TOSHIBA (1) ASSUMES NO LIABILITY WHATSOEVER, INCLUDING WITHOUT LIMITATION, INDIRECT, CONSEQUENTIAL, SPECIAL, OR INCIDENTAL DAMAGES OR LOSS, INCLUDING WITHOUT LIMITATION, LOSS OF PROFITS, LOSS OF OPPORTUNITIES, BUSINESS INTERRUPTION AND LOSS OF DATA, AND (2) DISCLAIMS ANY AND ALL EXPRESS OR IMPLIED WARRANTIES AND CONDITIONS RELATED TO SALE, USE OF PRODUCT, OR INFORMATION, INCLUDING WARRANTIES OR CONDITIONS OF MERCHANTABILITY, FITNESS FOR A PARTICULAR PURPOSE, ACCURACY OF INFORMATION, OR NONINFRINGEMENT.**
- Do not use or otherwise make available Product or related software or technology for any military purposes, including without limitation, for the design, development, use, stockpiling or manufacturing of nuclear, chemical, or biological weapons or missile technology products (mass destruction weapons). Product and related software and technology may be controlled under the Japanese Foreign Exchange and Foreign Trade Law and the U.S. Export Administration Regulations. Export and re-export of Product or related software or technology are strictly prohibited except in compliance with all applicable export laws and regulations.
- Please contact your TOSHIBA sales representative for details as to environmental matters such as the RoHS compatibility of Product. Please use Product in compliance with all applicable laws and regulations that regulate the inclusion or use of controlled substances, including without limitation, the EU RoHS Directive. TOSHIBA assumes no liability for damages or losses occurring as a result of noncompliance with applicable laws and regulations.