

■ Features :

- Meet 1U rack mount system
- Universal AC input / Full range
- Active power factor $\geq 94\%$
- Protections: Short circuit/Overload/Over voltage
- Forced air cooling by built-in DC fan
- With power good and fail signal output
- Built-in remote ON-OFF control
- Remote DC sense +5V and +3.3V
- With +5VSB: 0 ~ 2.0A max.
- 100% full load burn-in test
- High efficiency
- 2 years warranty



SPECIFICATION

MODEL		IPC-250					
OUTPUT	OUTPUT NUMBER	CH1	CH2	CH3	CH4	CH5	STANDBY
	DC VOLTAGE	3.3V	5V	12V	-5V	-12V	5VSB
	RATED CURRENT	20A	25A	15A	0.5A	1A	2A
	CURRENT RANGE	0 ~ 20A	1 ~ 25A	1 ~ 15A	0 ~ 0.5A	0.1 ~ 1A	0 ~ 2A
	RATED POWER	250W continue. +5V,+3.3V,+12V combine total power output shall not exceed 230W. (The +5 & +3.3V combine total output shall not exceed 150W) (The -5 & -12V combine total output shall not exceed 12W)					
	RIPPLE & NOISE (max.) Note.2	50mVp-p	50mVp-p	120mVp-p	100mVp-p	120mVp-p	50mVp-p
	VOLTAGE ADJ. RANGE	CH2 : 5.05 ~ 5.5V					
	VOLTAGE TOLERANCE Note.3	$\pm 5.0\%$	$\pm 5.0\%$	$\pm 7.0\%$	$\pm 8.0\%$	$\pm 10\%$	$\pm 5.0\%$
	LINE REGULATION	$\pm 1.0\%$	$\pm 1.0\%$	$\pm 1.0\%$	$\pm 2.0\%$	$\pm 2.0\%$	$\pm 1.0\%$
	LOAD REGULATION	$\pm 5.0\%$	$\pm 5.0\%$	$\pm 7.0\%$	$\pm 8.0\%$	$\pm 10\%$	$\pm 5.0\%$
SETUP, RISE TIME	800ms, 20ms/230VAC 2500ms, 20ms/115VAC at full load						
HOLD TIME (Typ.)	16ms/230VAC 16ms/115VAC at full load						
INPUT	VOLTAGE RANGE	90 ~ 264VAC					
	FREQUENCY RANGE	47 ~ 63Hz					
	EFFICIENCY (Typ.)	75%					
	AC CURRENT (Typ.)	4A/115VAC 2A/230VAC					
	INRUSH CURRENT (Typ.)	40A/115VAC 80A/230VAC					
	LEAKAGE CURRENT(max.)	3mA/240VAC					
PROTECTION	OVER LOAD	105 ~ 150% rated output power Protection type : Shut down o/p voltage, re-power on to recover					
	OVER VOLTAGE	+3.3V, +5V: 110% ~ 140% of rated voltage ; +12V: 13.2V ~ 16V Protection type : Shut down o/p voltage, re-power on to recover					
	SHORT CIRCUIT	All output equipped with short circuit Protection type : Shut down o/p voltage, re-power on to recover					
FUNCTION	POWER GOOD SIGNAL	The TTL compatible signal out with 100ms to 500ms delay after power set up					
	POWER FAIL SIGNAL	The TTL compatible signal will go down at least 1ms before +5V below 4.75V					
	PS-ON INPUT SIGNAL	Power off: PS-ON = "Hi" or ">2V" ; Power on: PS-ON = "Low" or "<0.5V"					
ENVIRONMENT	WORKING TEMP.	-10 ~ +60°C (Refer to "Derating Curve")					
	WORKING HUMIDITY	20 ~ 90% RH non-condensing					
	STORAGE TEMP., HUMIDITY	-40 ~ +85°C 10 ~ 95% RH					
	TEMP. COEFFICIENT	$\pm 0.05\% / ^\circ\text{C}$ (0 ~ 50°C)					
	VIBRATION	10 ~ 500Hz, 2G 10min./1cycle, 60min. each along X, Y, Z axes					
SAFETY & EMC (Note 4)	SAFETY STANDARDS	UL60950-1, TUV EN60950-1 approved					
	WITHSTAND VOLTAGE	I/P-O/P: 1.5KVAC I/P-FG: 1.5KVAC					
	ISOLATION RESISTANCE	I/P-O/P, I/P-FG, O/P-FG: 50M Ohms / 500VDC / 25°C / 70% RH					
	EMC EMISSION	Compliance to EN55022 (CISPR22) Class B, Design refer to FCC part 15 Class B, EN61000-3-2,-3					
OTHERS	EMC IMMUNITY	Compliance to EN61000-4-2,3,4,5,6,8,11, EN55024, EN61000-6-2 (EN50082-2), heavy industry level, criteria A					
	MTBF	94.1K hrs min. MIL-HDBK-217F (25°C)					
	CONNECTOR	ATX main power connector * 1ea; +12V power connector * 1ea Peripheral power connector * 3ea; Floppy drive power connector * 1ea					
	COOLING	Forced air ventilation by 4cm DC fan					
	DIMENSION	240*83*40mm (L*W*H)					
	PACKING	1.44Kg; 10pcs/15.4Kg/0.89CUFT					
NOTE	<p>1. All parameters NOT specially mentioned are measured at 230VAC input, rated load and 25°C of ambient temperature.</p> <p>2. Ripple & noise are measured at 20MHz of bandwidth by using a 12" twisted pair-wire terminated with a 0.1uf & 47uf parallel capacitor.</p> <p>3. Load regulation is measured from 20% to 100% max. Load.</p> <p>4. The power supply is considered a component which will be installed into a final equipment. The final equipment must be re-confirmed that it still meets EMC directives. For guidance on how to perform these EMC tests, please refer to "EMI testing of component power supplies." (as available on http://www.meanwell.com)</p> <p>5. Derating may be needed under low input voltages. Please check the derating curve for more details.</p>						

Mechanical Specification

Case No. IPC-250 Unit:mm

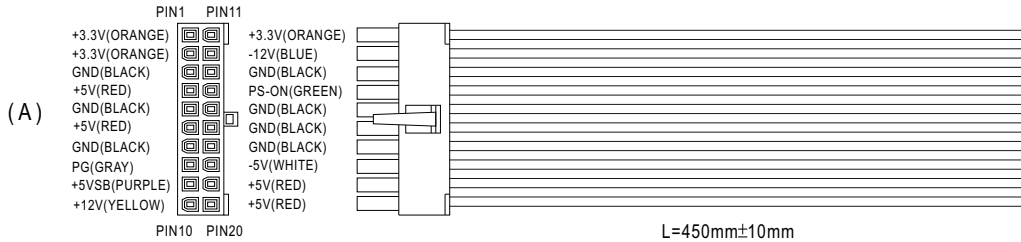
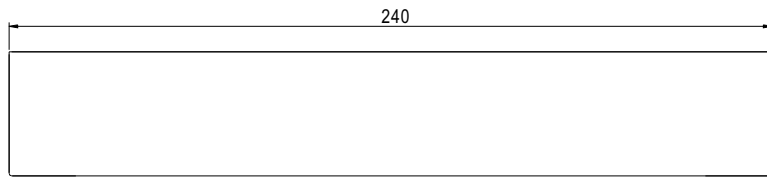
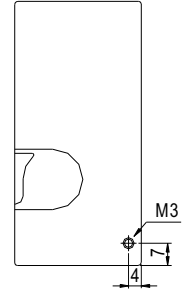
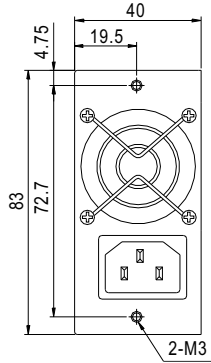

(WIRE OUTPUT OF PCB, 18AWG)

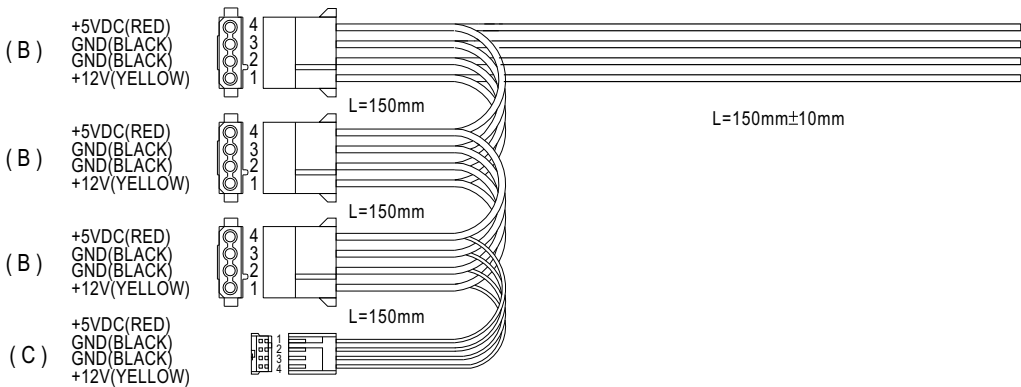

(A) MOLEX 39-01-2200 or equivalent

(B) MOLEX 8981-04P or equivalent

(C) AMP 171822-4 or equivalent

(D) MOLEX 39-01-2040 or equivalent



■ Block Diagram

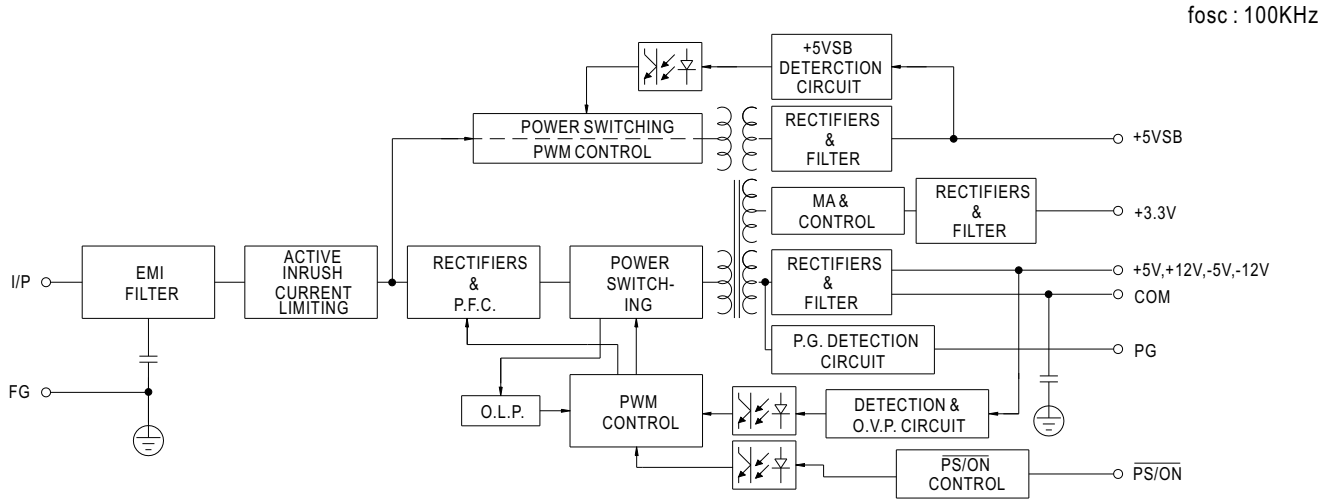

■ Derating Curve

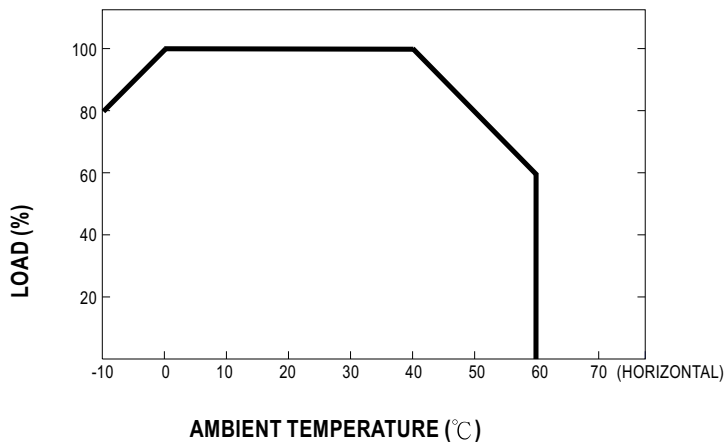

■ Output Derating VS Input Voltage

