

HIGH POWERED VSIP® TVS ARRAY

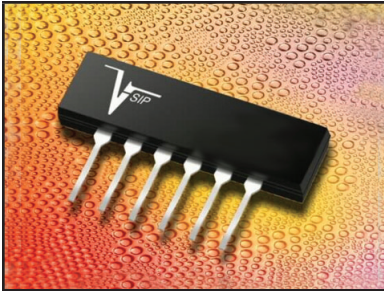

6 PIN VSIP® PACKAGE

DESCRIPTION

The VSB06P05LCI is a high powered, low capacitance TVS array available in a 6 pin VSIP package. This device is designed to protect telecommunications equipment from the damaging effects of ESD, EFT and secondary transient threats.

The VSB06P05LCI has a peak pulse power rating of 600 Watts for an 10/1000 μ s waveshape. This device meets the IEC 61000-4-2, IEC 61000-4-4 and IEC 61000-4-5 requirements.

FEATURES

- Compatible with IEC 61000-4-2 (ESD): Air - 15kV, Contact - 8kV
- Compatible with IEC 61000-4-4 (EFT): 40A - 5/50ns
- Compatible with IEC 61000-4-5 (Surge): 8/20 μ s, 95A - Level 4 (Line-Gnd) & 48A, Level 4 (Line-Line), 83A Level 2 (Power)
- 600 Watts Peak Pulse Power per Line (tp = 10/1000 μ s)
- 100A (2/10 μ s) per Bellcore GR-1089 (Intra Building)
- ESD Protection > 25 kilovolts
- High Surge Capability
- Low Capacitance: < 50pF
- RoHS Compliant
- REACH Compliant

APPLICATIONS

- RS-232 & RS-423 Data Lines
- T1/E1 & T3/E3
- ATM Circuit Interfaces
- xDSL Interfaces
- Cable Modem Intra-Structure Protection
- V.34/V.90

MECHANICAL CHARACTERISTICS

- Molded 6 Pin Plastic VSIP® Package
- Approximate Weight: 1.5 grams
- Lead-Free Pure-Tin Plating (Annealed)
- Solder Reflow Temperature:
Pure-Tin - Sn, 100: 260-270°C
- Flammability Rating UL 94V-0

PIN CONFIGURATION

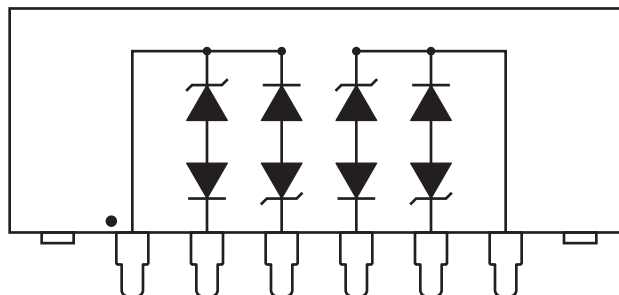

TYPICAL DEVICE CHARACTERISTICS
MAXIMUM RATINGS @ 25°C Unless Otherwise Specified

PARAMETER	SYMBOL	VALUE	UNITS
Peak Pulse Power (tp = 10/1000μs) - See Figure 1	P_{PP}	600	Watts
Operating Temperature	T_L	-55 to 150	°C
Storage Temperature	T_{STG}	-55 to 150	°C

SERIES "A" ELECTRICAL CHARACTERISTICS PER LINE @ 25°C Unless Otherwise Specified

PART NUMBER (Note 1)	RATED STAND-OFF VOLTAGE V_{WM} VOLTS	MINIMUM BREAKDOWN VOLTAGE @1mA $V_{(BR)}$ VOLTS	MAXIMUM CLAMPING VOLTAGE (Fig. 2) @ IP = 10A V_C VOLTS	MAXIMUM CLAMPING VOLTAGE (Fig. 2) @ 10/1000μs $V_C @ I_{PP}$	MAXIMUM LEAKAGE CURRENT @ V_{WM} I_D μA	MAXIMUM CAPACITANCE @ 0V, 1MHz C_J pF
VSB06P05LCI	5.0	6.0	12.5	16.5V @ 36.0A	300	50

NOTES

- Do not surge from pins 2 to 1, 1 to 3, 4 to 6 or 6 to 5. PIV typically greater than 100 Volts for each rectifier diode. For circuit applications, external pins 2, 3, 4 and 5 are not connected.

TYPICAL DEVICE CHARACTERISTICS

FIGURE 1
PEAK PULSE POWER VS PULSE TIME

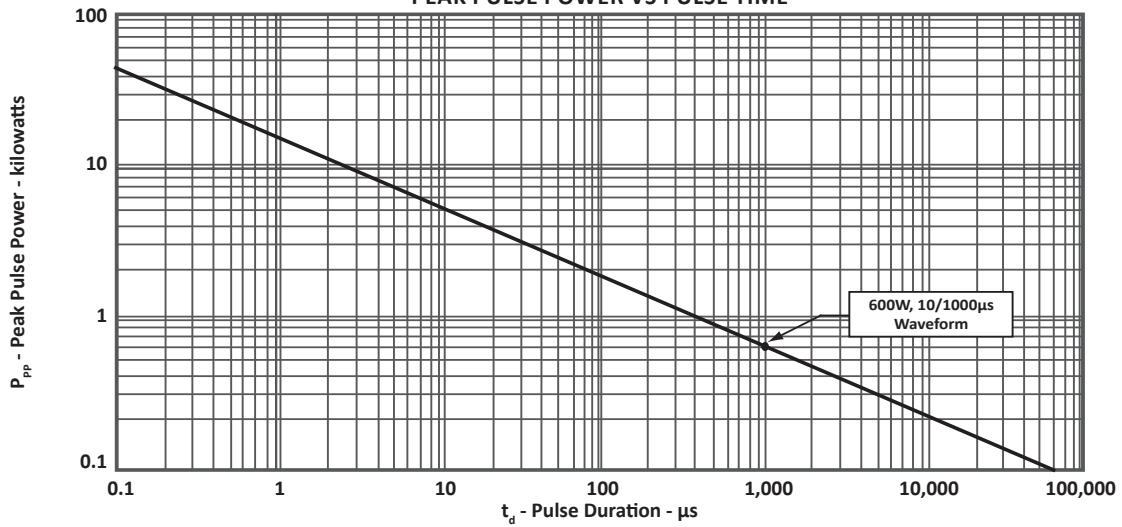

FIGURE 2
PULSE WAVEFORM

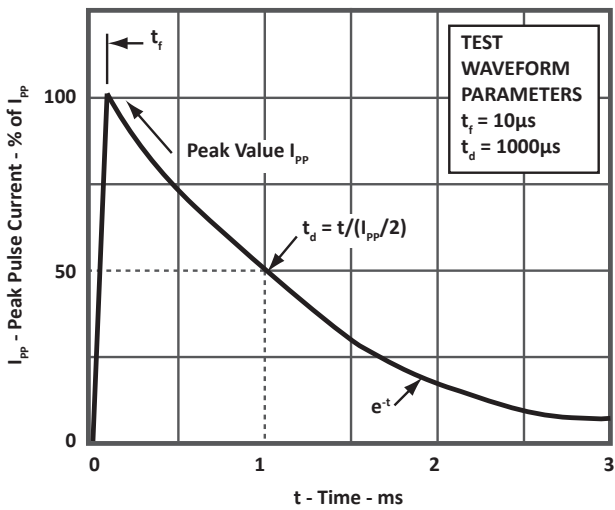
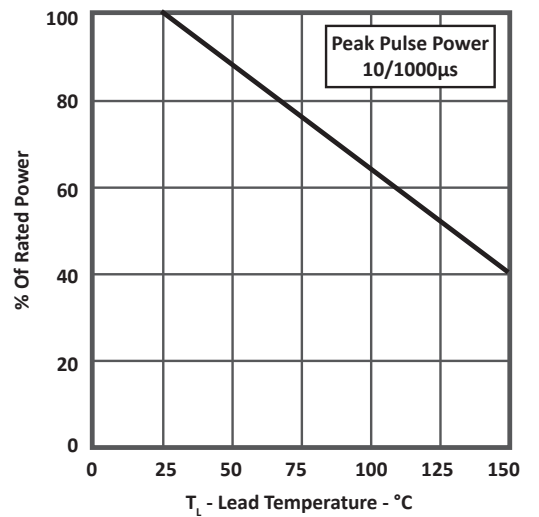
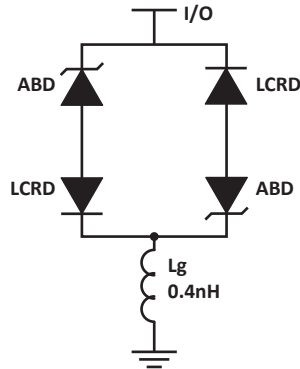

FIGURE 3
POWER DERATING CURVE



SPICE MODEL

FIGURE 1
SPICE MODEL



ABD - Avalanche Breakdown Diode (TVS)
 LCRD: Low Capacitance Rectifier Diode
 Lg - Lead Inductance

TABLE 1 - SPICE PARAMETERS

PARAMETER	UNIT	ABD(TVS)	LCRD
BV	V	See Table 2	200
IBV	μA	1	0.01
C_{jo}	pF	See Table 2	5
I_s	A	See Table 2	1E-13
Vj	V	0.6	0.6
M	-	0.33	0.33
N	-	1	1
R_s	Ohms	See Table 2	0.31
TT	s	1E-8	1E-9
EG	eV	1.11	1.11

TABLE 2 - ABD SPECIFIC SPICE PARAMETERS

PART NUMBER	B_v (VOLTS)	C_{jo} (pF)	I_s (AMPS)	R_s (OHMS)
VSB06P05LCI	6.0	3000	1E-11	0.075

6 PIN VSIP PACKAGE INFORMATION

OUTLINE DIMENSIONS

DIM	MILLIMETERS		INCHES	
	MIN	MAX	MIN	MAX
A	18.92	20.57	0.745	0.810
B	5.68	6.45	0.244	0.254
C	5.92	6.73	0.233	0.265
D	0.406	0.508	0.016	0.020
E	1.27	1.65	0.05	0.065
F	2.49	2.59	0.098	0.102
G	0.38	1.40	0.015	0.055
H	3.05	3.81	0.120	0.150
I	7° TYP	7° TYP	7° TYP	7° TYP
J	1.78	2.03	0.070	0.080
K	0.20	0.30	0.008	0.012
L	1.52	1.78	0.060	0.070

NOTES

- Dimensions are exclusive of mold flash and metal burrs.
- Controlling dimensions in inches.

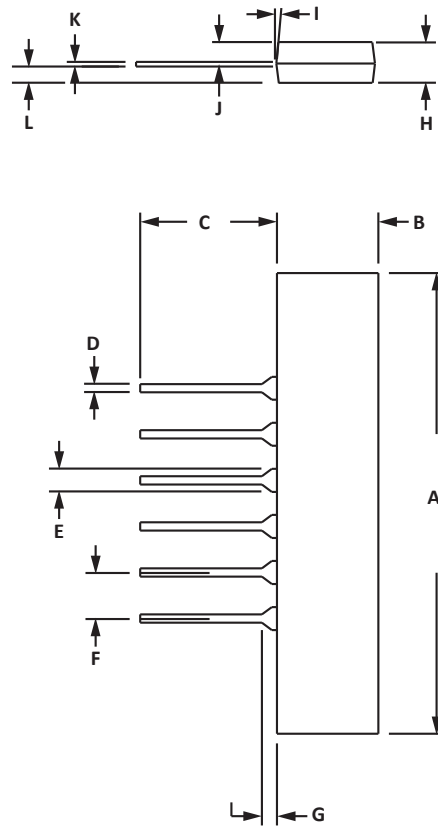

ORDERING INFORMATION

BASE PART NUMBER	LEADFREE SUFFIX	TAPE SUFFIX	QTY/REEL	REEL SIZE	TUBE QTY
VSB06P05LCI	-LF	n/a	n/a	n/a	25

NOTES

- Marking on Part - logo, part number, date code and pin one defined by dot on top of package.

Package outline per document number 06016.R2 1/11.

COMPANY INFORMATION

COMPANY PROFILE

ProTek Devices, based in Tempe, Arizona USA, is a manufacturer of Transient Voltage Suppression (TVS) products designed specifically for the protection of electronic systems from the effects of lightning, Electrostatic Discharge (ESD), Nuclear Electromagnetic Pulse (NEMP), inductive switching and EMI/RFI. With over 25 years of engineering and manufacturing experience, ProTek designs TVS devices that provide application specific protection solutions for all electronic equipment/systems.

ProTek Devices Analog Products Division, also manufactures analog interface, control, RF and power management products.

CONTACT US

Corporate Headquarters

2929 South Fair Lane
Tempe, Arizona 85282
USA

By Telephone

General: 602-431-8101
Sales: 602-414-5109
Customer Service: 602-414-5114

By Fax

General: 602-431-2288

By E-mail:

Sales: sales@protekdevices.com
Customer Service: service@protekdevices.com
Technical Support: support@protekdevices.com

Web

www.protekdevices.com
www.protekanalog.com

COPYRIGHT © ProTek Devices 2000 - This literature is subject to all applicable copyright laws and is not for resale in any manner.

SPECIFICATIONS: ProTek reserves the right to change the electrical and or mechanical characteristics described herein without notice.

DESIGN CHANGES: ProTek reserves the right to discontinue product lines without notice and that the final judgement concerning selection and specifications is the buyer's and that in furnishing engineering and technical assistance. ProTek assumes no responsibility with respect to the selection or specifications of such products. ProTek makes no warranty, representation or guarantee regarding the suitability of its products for any particular purpose, nor does ProTek assume any liability arising out of the application or use of any product or circuit and specifically disclaims any and all liability without limitation special, consequential or incidental damages.

LIFE SUPPORT POLICY: ProTek Devices products are not authorized for use in life support systems without written consent from the factory.