

## Features

- 30V/68A,  
 $R_{DS(ON)} = 6m$  (tpy.) @  $V_{GS} = 10V$   
 $R_{DS(ON)} = 10m$  (tpy.) @  $V_{GS} = 4.5V$
- Super High Dense Cell Design
- Ultra Low On-Resistance
- 100% avalanche tested
- Lead Free and Green Devices Available  
 (RoHS Compliant)

## Applications

- DC-DC Converters

## Pin Description



## Absolute Maximum Ratings

Symbol	Parameter	Rating	Unit
<b>Common Ratings</b> ( $T_C = 25^\circ\text{C}$ Unless Otherwise Noted)			
$V_{DSS}$	Drain-Source Voltage	30	V
$V_{GSS}$	Gate-Source Voltage	$\pm 20$	
$T_J$	Maximum Junction Temperature	175	$^\circ\text{C}$
$T_{STG}$	Storage Temperature Range	-55 to 175	$^\circ\text{C}$
$I_S$	Diode Continuous Forward Current	$T_C = 25^\circ\text{C}$ 68 <sup>①</sup>	A
<b>Mounted on Large Heat Sink</b>			
$I_{DP}$	300 $\mu\text{s}$ Pulse Drain Current Tested	$T_C = 25^\circ\text{C}$ 270 <sup>②</sup>	A
$I_D$	Continuous Drain Current	$T_C = 25^\circ\text{C}$ 68 <sup>①</sup>	A
		$T_C = 100^\circ\text{C}$ 50	
$P_D$	Maximum Power Dissipation	$T_C = 25^\circ\text{C}$ 65	W
		$T_C = 100^\circ\text{C}$ 33	W
$R_{\theta JC}$	Thermal Resistance-Junction to Case	2.3	$^\circ\text{C/W}$
<b>Drain-Source Avalanche Ratings</b>			
$E_{AS}$ <sup>③</sup>	Avalanche Energy, Single Pulsed	132	mJ

**Electrical Characteristics** ( $T_C=25^\circ\text{C}$  Unless Otherwise Noted)

Symbol	Parameter	Test Condition	RU3568R			Unit
			Min.	Typ.	Max.	
<b>Static Characteristics</b>						
$BV_{DSS}$	Drain-Source Breakdown Voltage	$V_{GS}=0V, I_{DS}=250\mu A$	30			V
$I_{DSS}$	Zero Gate Voltage Drain Current	$V_{DS}=30V, V_{GS}=0V$			1	$\mu A$
		$T_J=85^\circ C$			30	
$V_{GS(th)}$	Gate Threshold Voltage	$V_{DS}=V_{GS}, I_{DS}=250\mu A$	1.5	2	2.7	V
$I_{GSS}$	Gate Leakage Current	$V_{GS}=\pm 20V, V_{DS}=0V$			$\pm 100$	nA
$R_{DS(ON)}^{(4)}$	Drain-Source On-state Resistance	$V_{GS}=10V, I_{DS}=30A$		6	8	$m\Omega$
		$V_{GS}=4.5V, I_{DS}=25A$		10	15	$m\Omega$
<b>Diode Characteristics</b>						
$V_{SD}^{(4)}$	Diode Forward Voltage	$I_{SD}=30A, V_{GS}=0V$			1.2	V
$t_{rr}$	Reverse Recovery Time	$I_{SD}=30A, dI_{SD}/dt=100A/\mu s$		14		ns
$Q_{rr}$	Reverse Recovery Charge			20		nC
<b>Dynamic Characteristics</b> <sup>(5)</sup>						
$R_G$	Gate Resistance	$V_{GS}=0V, V_{DS}=0V, F=1MHz$		1.4		$\Omega$
$C_{iss}$	Input Capacitance	$V_{GS}=0V,$ $V_{DS}=15V,$ Frequency=1.0MHz		1160		pF
$C_{oss}$	Output Capacitance			210		
$C_{rss}$	Reverse Transfer Capacitance			140		
$t_{d(ON)}$	Turn-on Delay Time	$V_{DD}=15V, R_L=0.5\Omega,$ $I_{DS}=30A, V_{GEN}=10V,$ $R_G=6\Omega$		9		ns
$t_r$	Turn-on Rise Time			13		
$t_{d(OFF)}$	Turn-off Delay Time			28		
$t_f$	Turn-off Fall Time			10		
<b>Gate Charge Characteristics</b> <sup>(5)</sup>						
$Q_g$	Total Gate Charge	$V_{DS}=24V, V_{GS}=10V,$ $I_{DS}=30A$		22	29	nC
$Q_{gs}$	Gate-Source Charge			4		
$Q_{gd}$	Gate-Drain Charge			7		

- Notes: ① Calculated continuous current based on maximum allowable junction temperature. Limited by bonding wire.  
 ② Pulse width limited by safe operating area.  
 ③ Limited by  $T_{Jmax}, I_{AS}=23A, V_{DD}=25V, R_G=50\Omega$ , Starting  $T_J=25^\circ C$ .  
 ④ Pulse test; Pulse width  $\leq 300\mu s$ , duty cycle  $\leq 2\%$ .  
 ⑤ Guaranteed by design, not subject to production testing.

**Typical Characteristics**

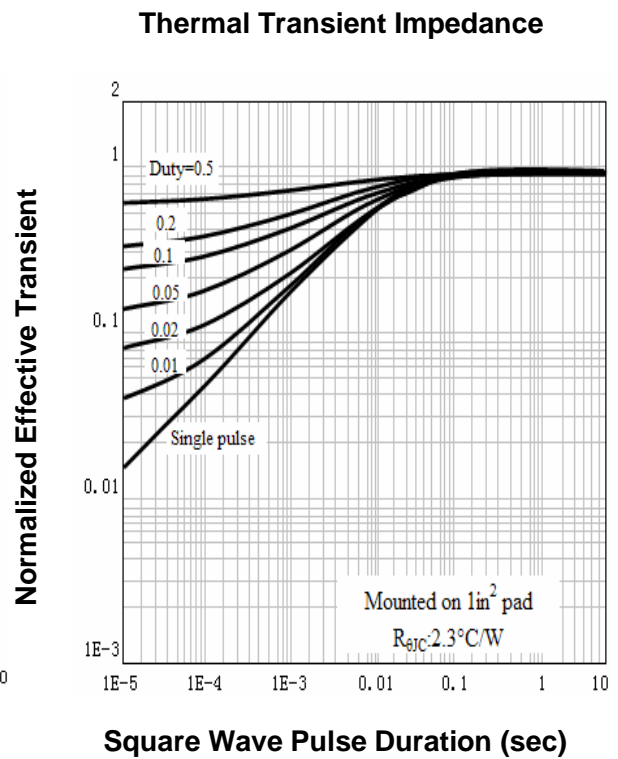
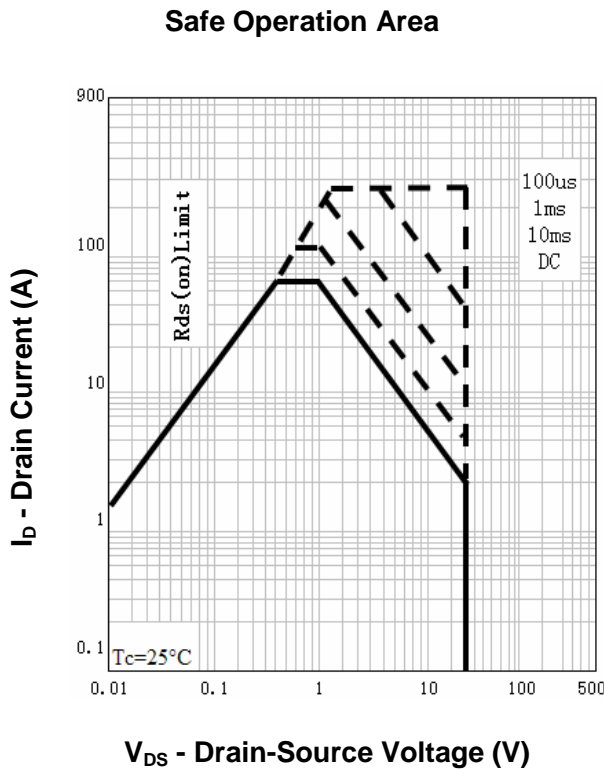
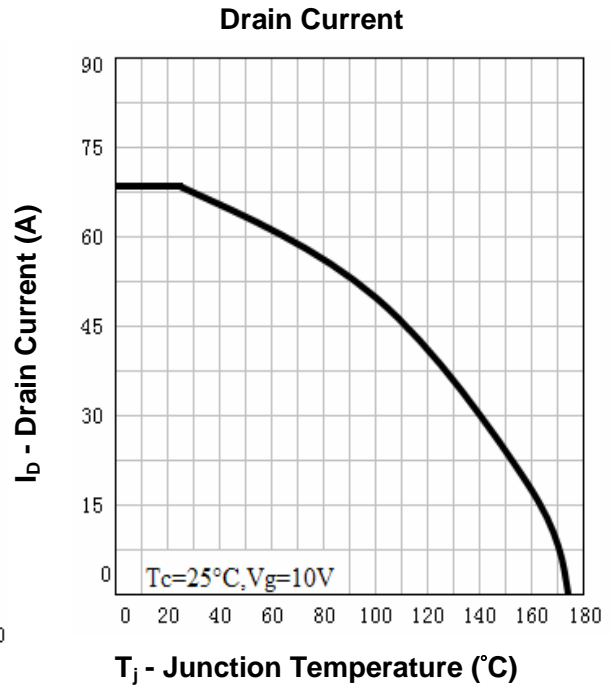
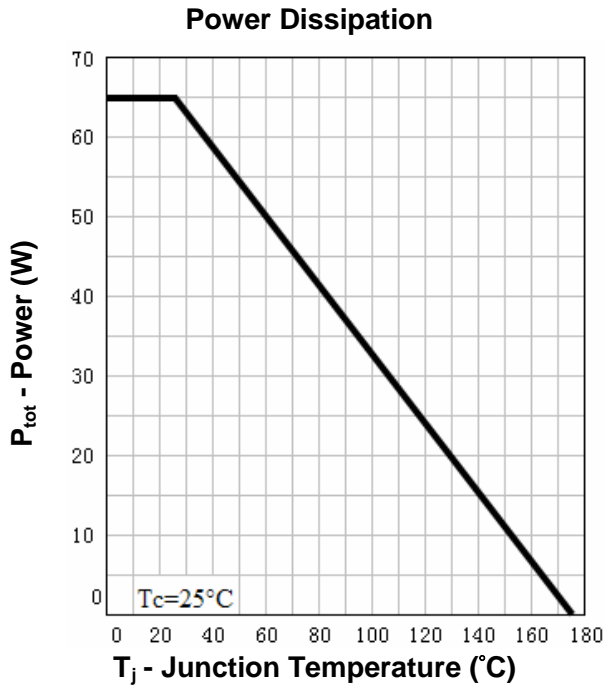

**Typical Characteristics**

**Output Characteristics**

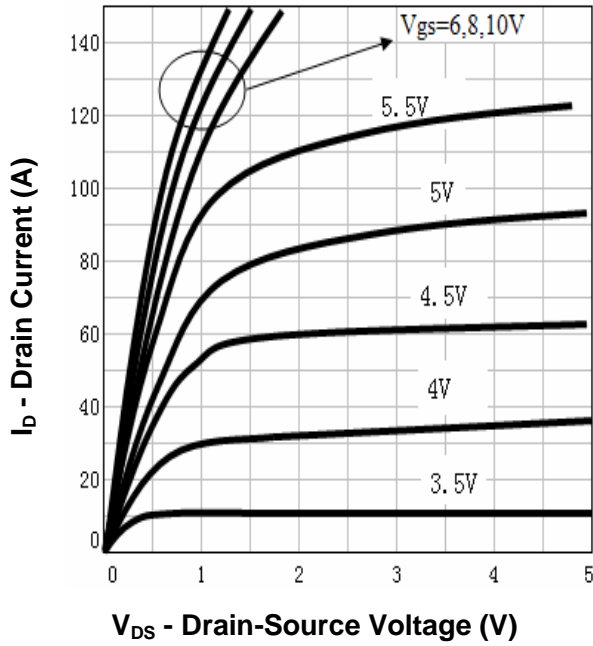

**Drain-Source On Resistance**

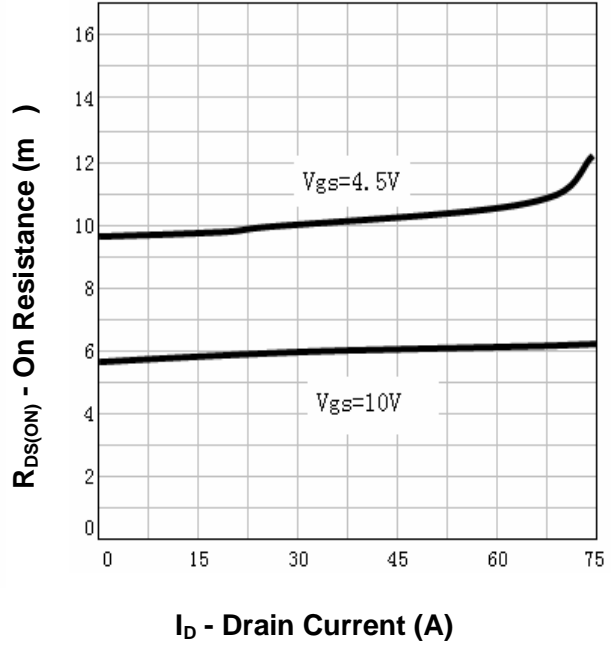

**Drain-Source On Resistance**

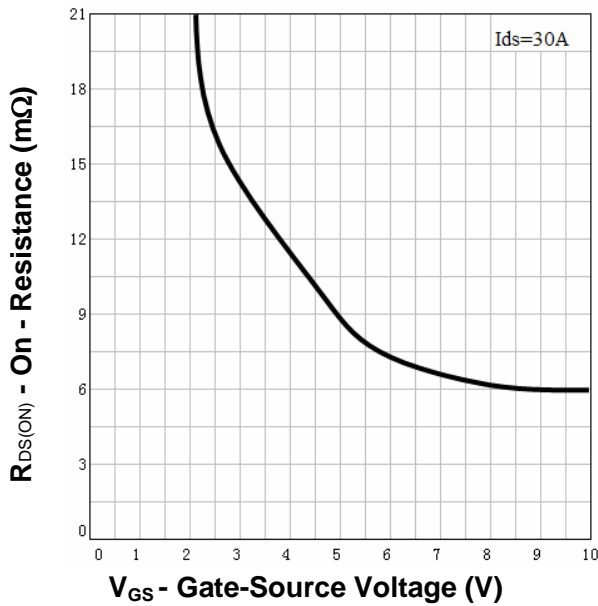

**Gate Threshold Voltage**

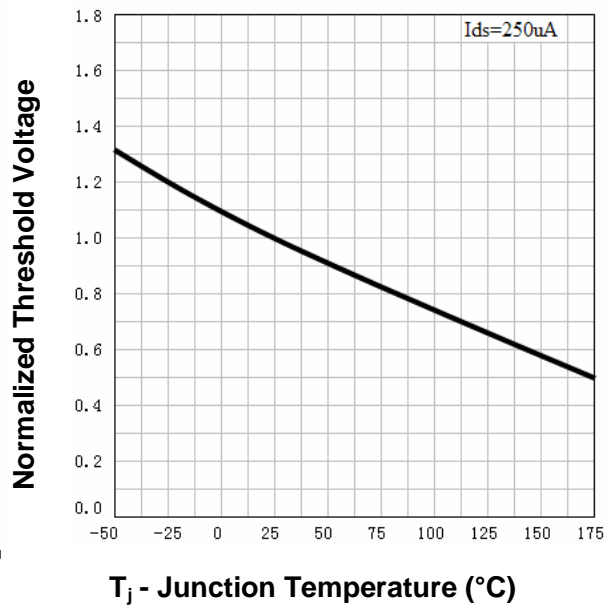

**Typical Characteristics**

**Drain-Source On Resistance**

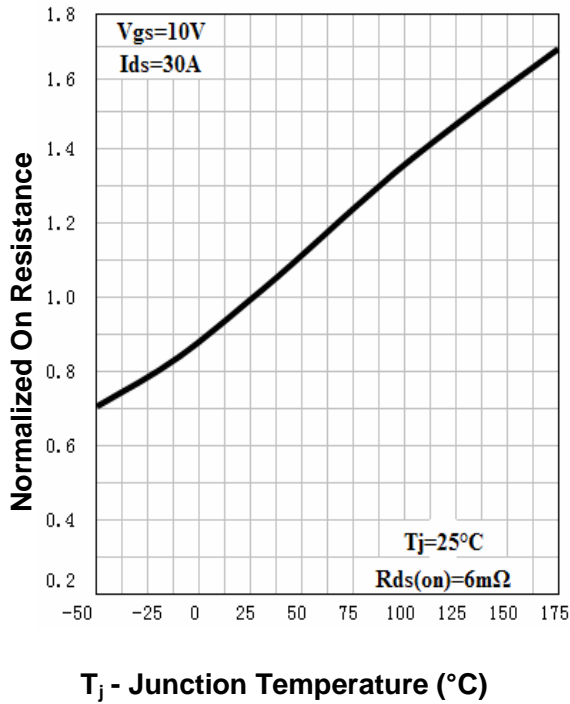

**Source-Drain Diode Forward**

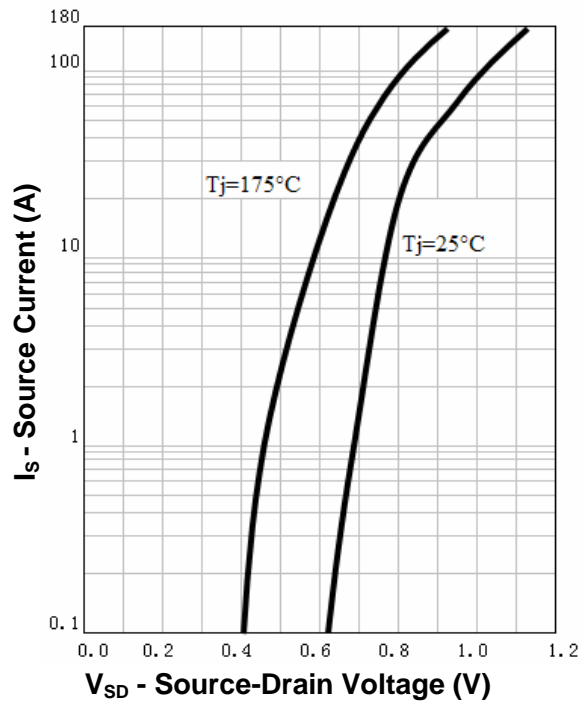

**Capacitance**

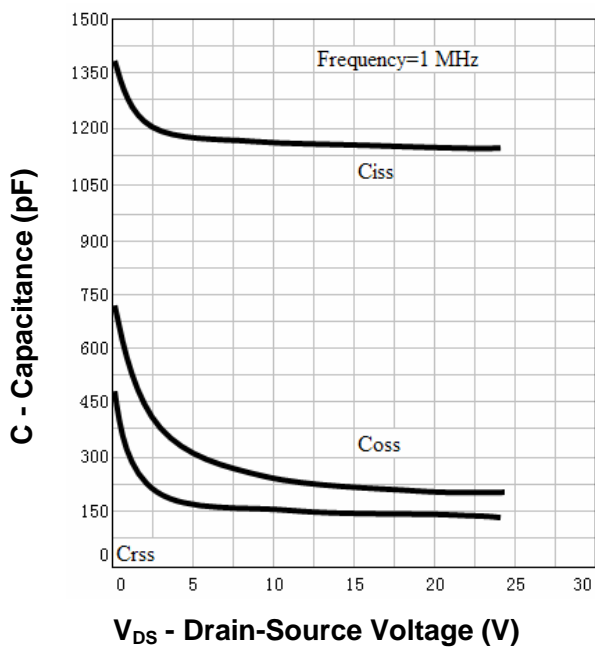

**Gate Charge**

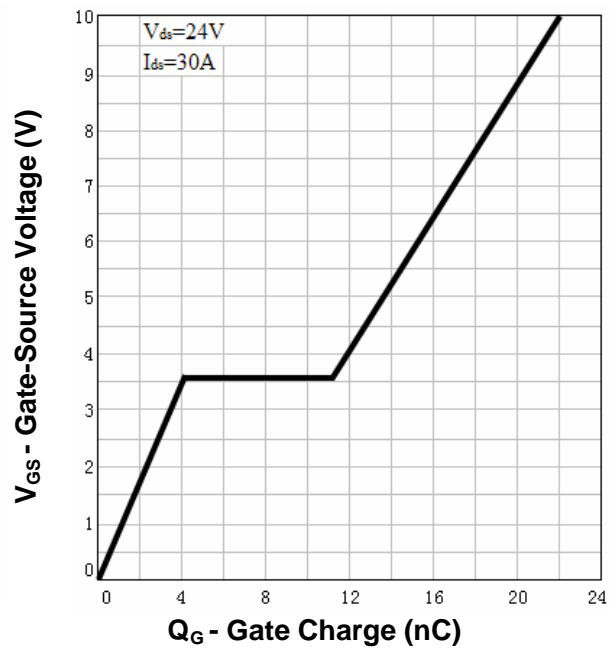

**Avalanche Test Circuit and Waveforms**

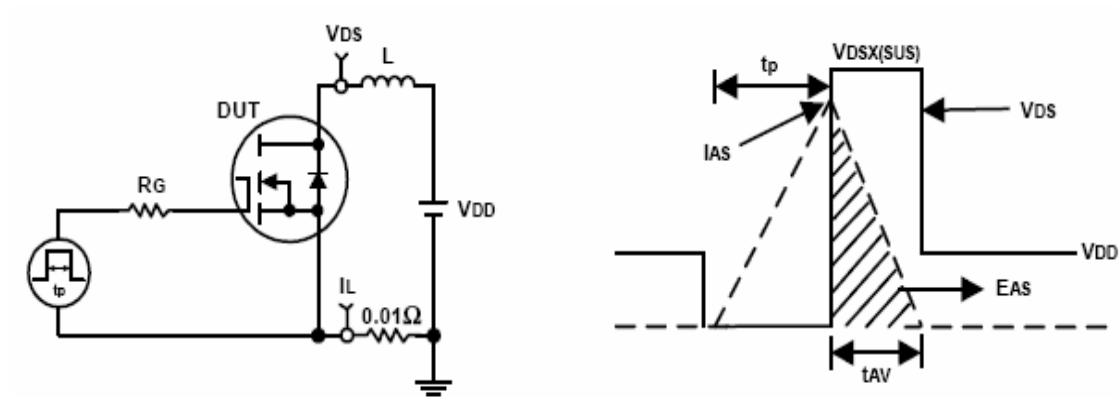

**Switching Time Test Circuit and Waveforms**

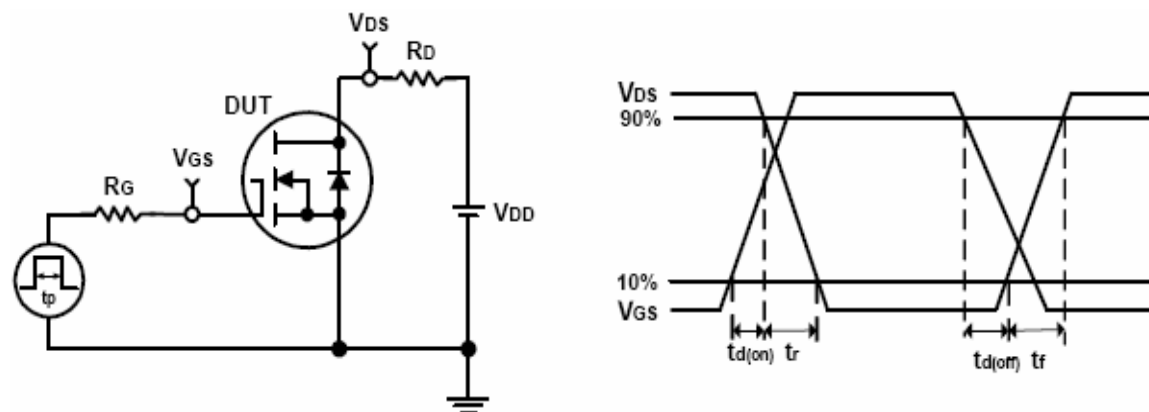

**Ordering and Marking Information****RU3568****Package (Available)**

R : TO220

**Operating Temperature Range**

C : -55 to 175 °C

**Assembly Material**

G : Green &amp; Lead Free

**Packaging**

T : TUBE

**Package Information**

**TO-220FB-3L**



SYMBOL	MM			INCH			SYMBOL	MM			INCH		
	MIN	NOM	MAX	MIN	NOM	MAX		MIN	NOM	MAX	MIN	NOM	MAX
A	4.40	4.57	4.70	0.173	0.180	0.185	$\phi p1$	1.40	1.50	1.60	0.055	0.059	0.063
A1	1.27	1.30	1.33	0.050	0.051	0.052	e	2.54BSC			0.1BSC		
A2	2.35	2.40	2.50	0.093	0.094	0.098	e1	5.08BSC			0.2BSC		
b	0.77	-	0.90	0.030	-	0.035	H1	6.40	6.50	6.60	0.252	0.256	0.260
b2	1.23	-	1.36	0.048	-	0.054	L	12.75	-	13.17	0.502	-	0.519
C	0.48	0.50	0.52	0.019	0.020	0.021	L1	-	-	3.95	-	-	0.156
D	15.40	15.60	15.80	0.606	0.614	0.622	L2	2.50REF.			0.098REF.		
D1	9.00	9.10	9.20	0.354	0.358	0.362	$\phi p$	3.57	3.60	3.63	0.141	0.142	0.143
DEP	0.05	0.10	0.20	0.002	0.004	0.008	Q	2.73	2.80	2.87	0.107	0.110	0.113
E	9.70	9.90	10.10	0.382	0.389	0.398	$\theta 1$	5°	7°	9°	5°	7°	9°
E1	-	8.70	-	-	0.343	-	$\theta 2$	1°	3°	5°	1°	3°	5°
E2	9.80	10.00	10.20	0.386	0.394	0.401							

ALL DIMENSIONS REFER TO JEDEC STANDARD  
DO NOT INCLUDE MOLD FLASH OR PROTRUSIONS



## Customer Service

**Worldwide Sales and Service:**

Sales@ruichips.com

**Technical Support:**

Technical@ruichips.com

**Investor Relations Contacts:**

Investor@ruichips.com

**Marcom Contact:**

Marcom@ruichips.com

**Editorial Contact:**

Editorial@ruichips.com

**HR Contact:**

HR@ruichips.com

**Legal Contact:**

Legal@ruichips.com

**Shen Zhen RUICHIPS Semiconductor CO., LTD**

Room 501, the 5floor An Tong Industrial Building,  
NO.207 Mei Hua Road Fu Tian Area Shen Zhen City, CHINA

**TEL:** (86-755) 8311-5334

**FAX:** (86-755) 8311-4278

**E-mail:** Sales-SZ@ruichips.com