

SERIES LC SWITCHES

PUSHBUTTON SWITCHES

TACT SWITCHES

NAVIGATION SWITCHES

PUSHBUTTON SWITCHES

TOGGLE SWITCHES

ROCKER SWITCHES

SLIDE SWITCHES

SNAP-ACTION SWITCHES

DIP SWITCHES

KEYLOCK SWITCHES

ROTARY SWITCHES

DETECTOR SWITCHES

CAP OPTIONS



FEATURES & BENEFITS

- ▶ Latching & momentary functions
- ▶ Shorting or non-shorting versions
- ▶ Variety of housing styles available

APPLICATIONS/MARKETS

- ▶ Telecommunications
- ▶ Networking
- ▶ Computers/servers
- ▶ Performance audio
- ▶ Instrumentation
- ▶ Low power on/off designs
- ▶ External hard drives and modems

SPECIFICATIONS

Contact Rating:	300mA @ 30 VDC
Life Expectancy:	10,000 cycles typical
Contact Resistance:	20mΩ max. initial @ 2-4 VDC, 100mA
Insulation Resistance:	100MΩ min.
Dielectric Strength:	1,000 V rms @ sea level
Actuation Force:	Dependent upon model number
Operating Temperature:	-20° to + 85°C

MATERIALS

Housing:	Tin over Steel
Actuator:	Acetal
Terminal Base:	Phenolic
Spring:	Spring steel
Terminals:	Silver over brass
Contacts:	Silver over phosphor bronze

HOW TO ORDER

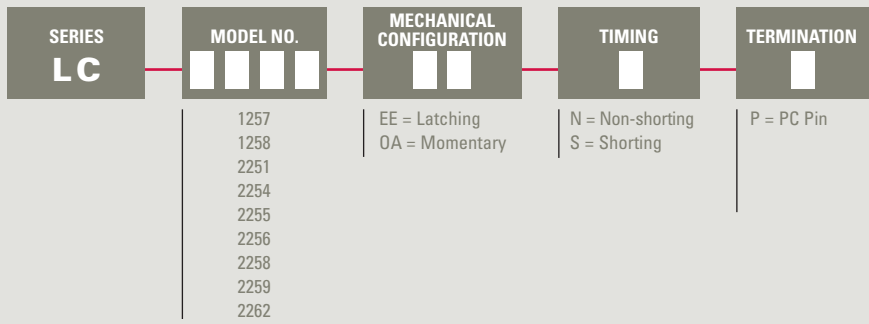

▶ ▶ ▶ **Example Ordering Number**
 LC-1257-EE-N-P

Specifications subject to change without notice.

ACTUATION OPTIONS

Model No.	Actuation Force
1257	230 ± 100 gf
1258	230 ± 100 gf
2251	330 ± 100 gf
2254	300 ± 150 gf
2255	300 ± 150 gf
2256	300 ± 150 gf
2258	330 ± 100 gf
2259	330 ± 100 gf
2262	200 ± 100 gf



LC 1257

Shaft End Style A

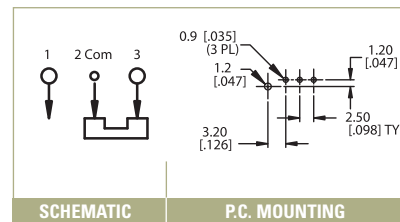
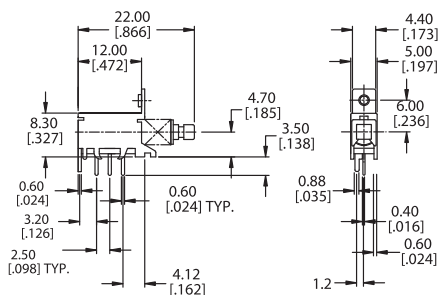

LC 1258

Shaft End Style A

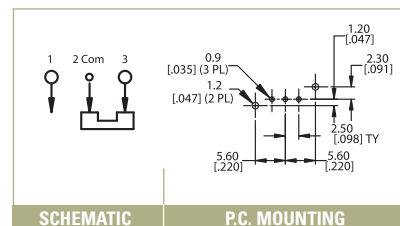
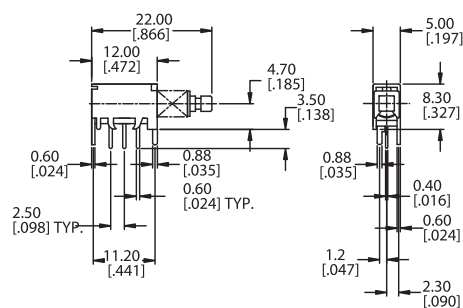

LC 2251

Shaft End Style A

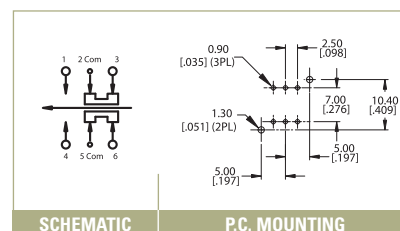
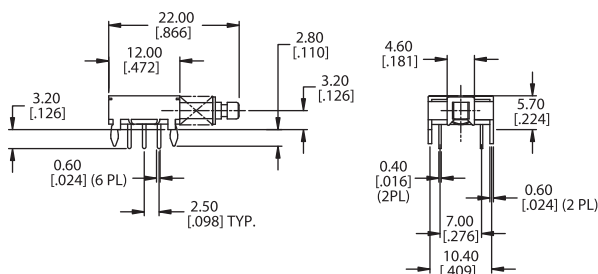

LC 2254

Shaft End Style □2.7mm

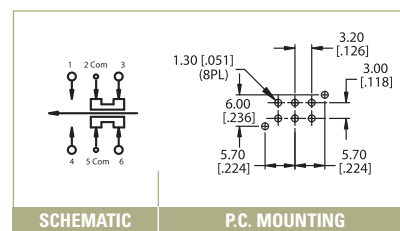
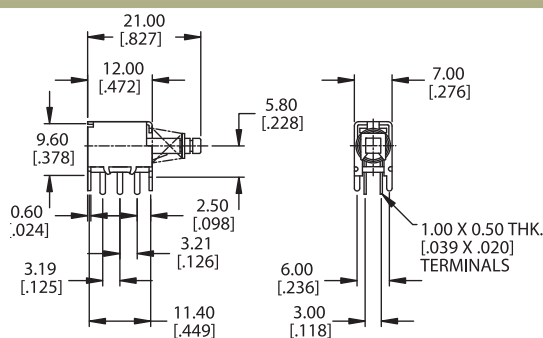

LC 2255

Shaft End Style B

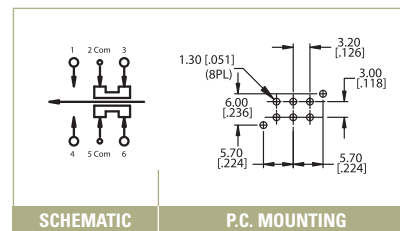
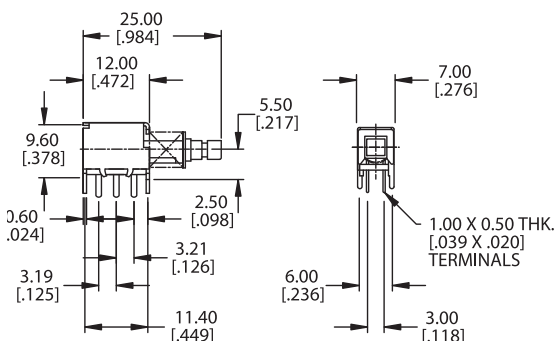

SERIES LC SWITCHES

PUSHBUTTON SWITCHES

TACT SWITCHES

NAVIGATION SWITCHES

PUSHBUTTON SWITCHES

TOGGLE SWITCHES

ROCKER SWITCHES

SLIDE SWITCHES

SNAP-ACTION SWITCHES

DIP SWITCHES

KEYLOCK SWITCHES

ROTARY SWITCHES

DETECTOR SWITCHES

CAP OPTIONS

LC 2256

Shaft End Style B

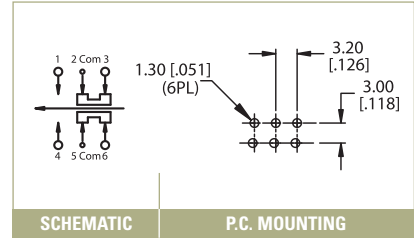
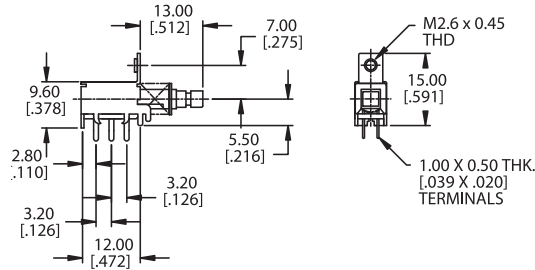

LC 2258

Shaft End Style A

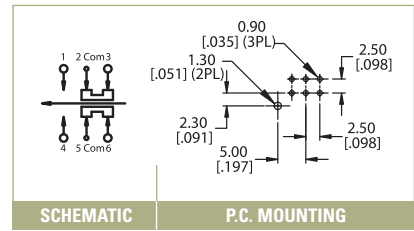
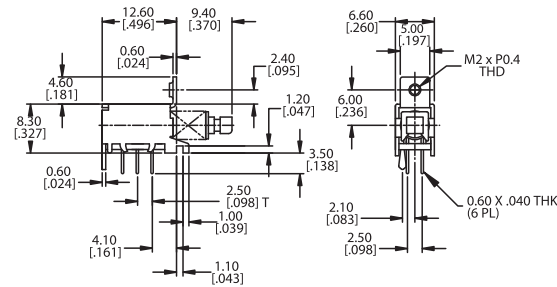

LC 2259

Shaft End Style A

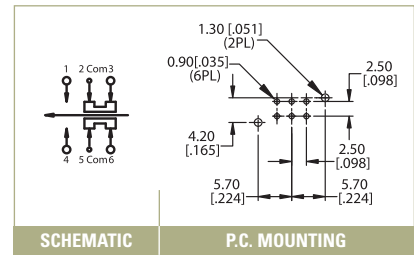
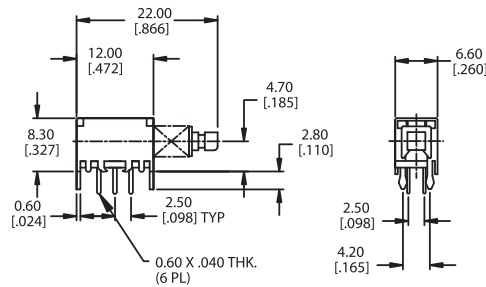

LC 2262

Shaft End Style Special - See Drawing

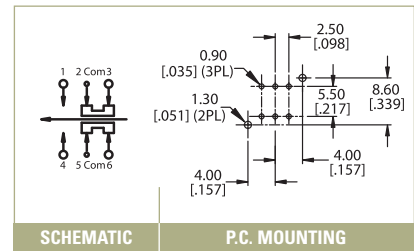
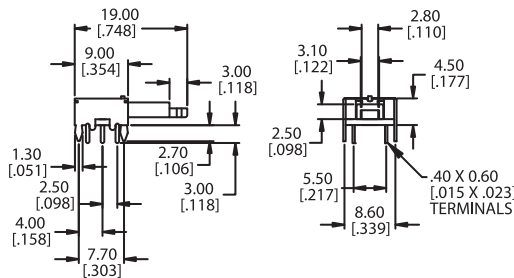

SHAFT END STYLES

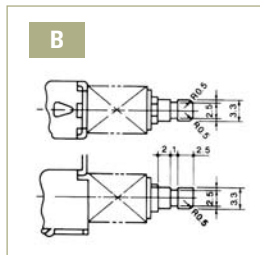
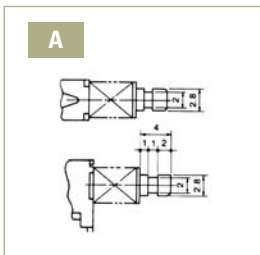

TERMINATION OPTIONS

