

F
E
D
C
B
A

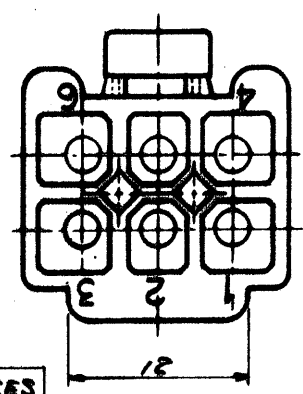

GENERAL TOLERANCES	
10 UNDER	±0.2
20 OVER 30 UNDER	±0.25
30 OVER	±0.3
ANGLE	±5°

			公差 (Tolerances) .000 → ±0.005 .00 → ±0.05 .0 → ±0.1 . → ±0.3		所要数 (Req) ★		DRWG. <i>G. Amano '77 TT</i>	
			材料 (MAT'L) NYLON 66, 94V-2				DSN'D <i>MENDONTO '80/7</i>	
			熱処理 (H.T.) HRc		CHK'D <i>K. S. Shin</i>		APP'D	
D	Qty: 1000 数量 ECN NO. 1486	7/21/77	仕上げ (Finish)		No. SD-5025-06R1		REV. Δ	
C	REMOVED 'X' ECN NO. 740	7/21/77	Scale 2/1				名称 (Name) MINI. FIT CONN. 6POS. RECEPTACLE HSG.	
B ₁	ロッキン7V7	7/21/77						
B	リブ.サーキットNO.	7/21/77						
A	REVISED	7/21/77						
O	PROPOSED	7/21/77						
記号 (LTR)	変更内容 (Rev.)	Date	Name					

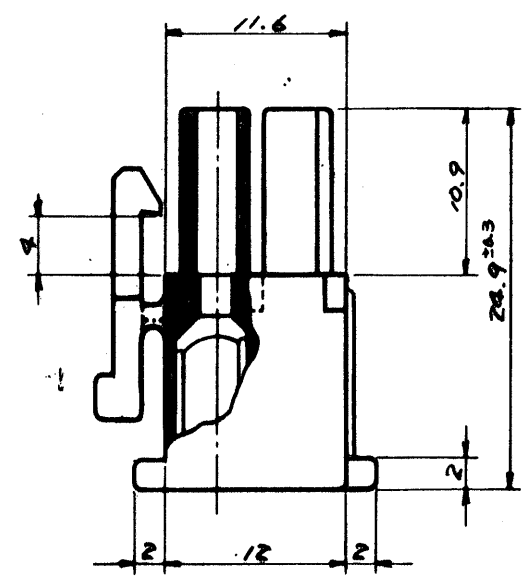
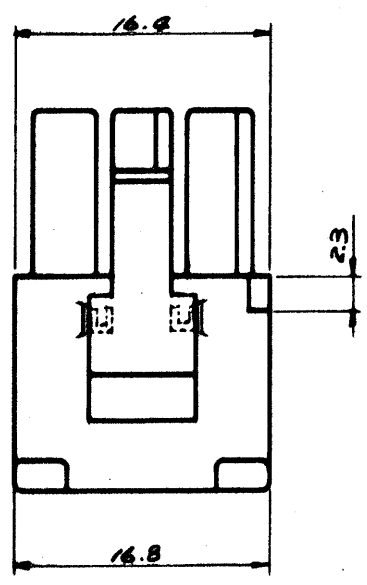
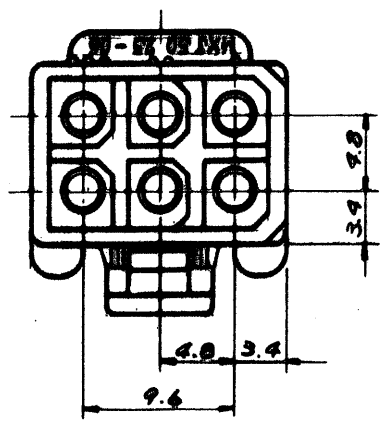

MOLEX-JAPAN CO., LTD.
日本モレックス株式会社

F
E
D
C
B
A

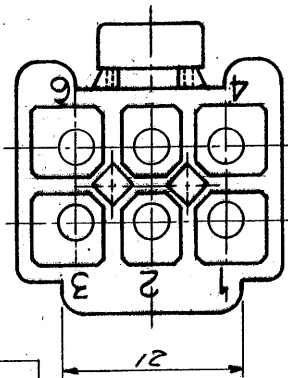
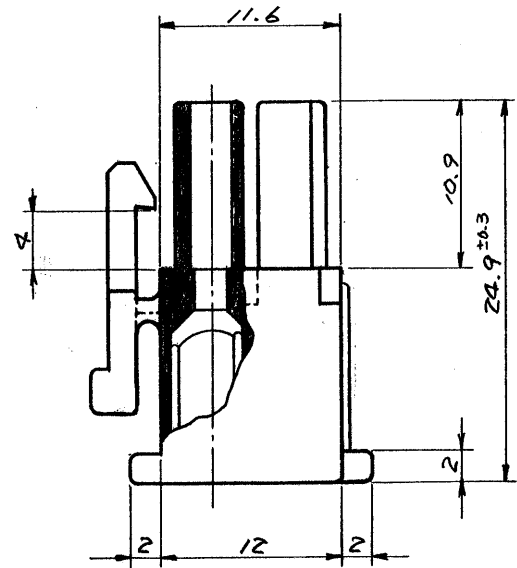
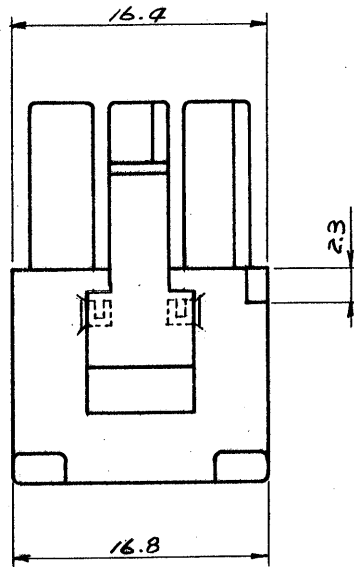
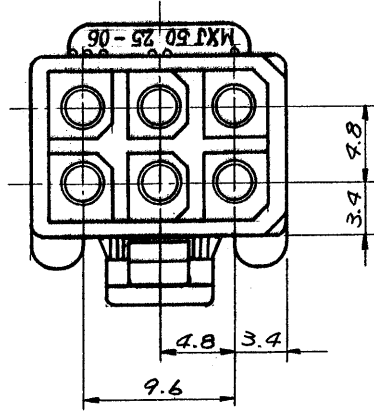

一般公差	
10 未満	±0.2
10以上30未満	±0.25
30 以上	±0.3
角度	±3°

				公差 (Tolerances) .000 → ±0.005 .00 → ±0.05 .0 → ±0.1 . → ±0.3	所要数 (Req) *	DRWG. <i>Y. Awano</i> '9/7 '77
				材料 (MAT'L) NYLON 66, 94V-2		DSN'D <i>M. ENDO</i> '9/17 '77
				熱処理 (H.T.) HRc	CHK'D <i>K. S. ...</i>	APP'D <i>W. ...</i>
①	ロッキング支柱 ECN. NO. 1486	11/21/79	<i>K.H.</i>	仕上げ (Finish)	MOLEX-JAPAN CO., LTD. 日本モレックス株式会社	
C	REMOVED "X" ECN. NO. 748	3/18/78	<i>...</i>	No. SD-5025-06R1	REV. D	
B ₁	ロッキングレバー	3/13/78	<i>...</i>	Scale 2/1	名称 (Name) MINI. FIT CONN. 6POS. RECEPTACLE HSG.	
B	リブ. サークット NO.	12/15/77	<i>...</i>			
A	REVISED	11/15/77	<i>...</i>			
O	PROPOSED	9/7 '77	<i>...</i>			
記号 (LTR)	変更内容 (Rev.)	Date	Name			