

Thyristor/Diode and Thyristor/Thyristor, 330A (MAGN-A-PAK Power Modules)



MAGN-A-PAK

FEATURES

- High voltage
- Electrically isolated by DBC ceramic (Al_2O_3)
- 3500 V_{RMS} isolating voltage
- Industrial standard package
- High surge capability
- Glass passivated chips
- Modules uses high voltage power thyristor/diodes in two basic configurations
- Simple mounting
- UL approved file E320098
- Compliant to RoHS
- Designed and qualified for multiple level

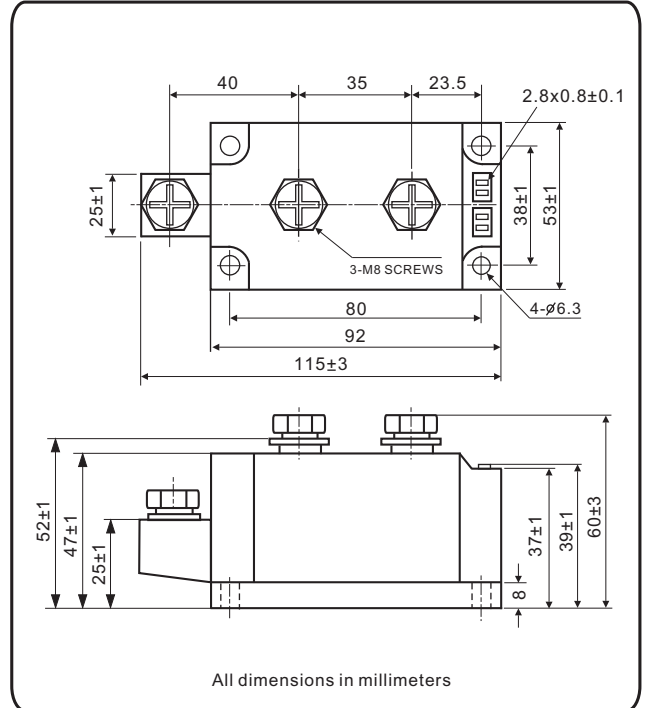

APPLICATIONS

- DC motor control and drives
- Battery charges
- Welders
- Power converters
- Lighting control
- Heat and temperature control
- Ups

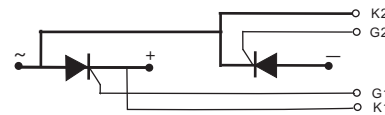

NKT

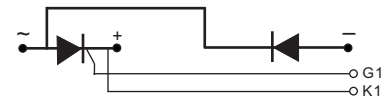

NKH

PRODUCT SUMMARY

$I_{T(AV)}$	330 A
-------------	-------

MAJOR RATINGS AND CHARACTERISTICS

SYMBOL	CHARACTERISTICS	VALUES	UNITS
$I_{T(AV)}$	85 °C	330	A
$I_{T(RMS)}$	85 °C	518	A
I_{TSM}	50 Hz	9300	
	60 Hz	9765	
I^2t	50 Hz	432	kA ² s
	60 Hz	394	
$I^2\sqrt{t}$		4325	kA ² \sqrt{s}
V_{DRM}/V_{RRM}	Range	400 to 1600	V
T_J	Range	-40 to 125	°C

ELECTRICAL SPECIFICATIONS

VOLTAGE RATINGS				
TYPE NUMBER	VOLTAGE CODE	V_{RRM}/V_{DRM} , MAXIMUM REPETITIVE PEAK REVERSE VOLTAGE V	V_{RSM}/V_{DSM} , MAXIMUM NON-REPETITIVE PEAK REVERSE VOLTAGE V	I_{RRM}/I_{DRM} AT 125 °C mA
NKT330 NKH330	04	400	500	40
	08	800	900	
	10	1000	1100	
	12	1200	1300	
	14	1400	1500	
	16	1600	1700	

FORWARD CONDUCTION								
PARAMETER	SYMBOL	TEST CONDITIONS		VALUES	UNITS			
Maximum average on-state current at case temperature	$I_{T(AV)}$	180° conduction, half sine wave ,50Hz		330	A			
				85	°C			
Maximum RMS on-state current	$I_{T(RMS)}$	180° conduction, half sine wave ,50Hz , $T_C = 85^{\circ}C$		518				
Maximum peak, one-cycle, on-state non-repetitive surge current	I_{TSM}	t = 10 ms	No voltage reappplied	Sine half wave, initial $T_J = T_J$ maximum	9300	A		
		t = 8.3 ms			9765			
Maximum I^2t for fusing	I^2t	t = 10 ms			100% V_{RRM} reappplied		432	kA ² s
		t = 8.3 ms					394	
		t = 10 ms	302					
		t = 8.3 ms	275					
Maximum $I^2\sqrt{t}$ for fusing	$I^2\sqrt{t}$	t = 0.1 ms to 10 ms, no voltage reappplied		4325	kA ² \sqrt{s}			
Maximum on-state voltage drop	V_{TM}	$I_{TM} = 900A$, $T_J = 25^{\circ}C$, 180° conduction		1.7	V			
Maximum forward voltage drop	V_{FM}	$I_{FM} = 900A$, $T_J = 25^{\circ}C$, 180° conduction		1.4				
Maximum holding current	I_H	Anode supply = 12 V initial $I_T = 1 A$, $T_J = 25^{\circ}C$		200	mA			
Maximum latching current	I_L	Anode supply = 12 V resistive load = 1 Ω Gate pulse: 10 V, 100 μs , $T_J = 25^{\circ}C$		400				

BLOCKING					
PARAMETER	SYMBOL	TEST CONDITIONS		VALUES	UNITS
Maximum peak reverse and off-state leakage current	I_{RRM} , I_{DRM}	$T_J = 125^{\circ}C$		40	mA
RMS isolation Voltage	V_{ISO}	50 Hz, circuit to base, all terminals shorted, 25 °C , 1s		3500	V
Critical rate of rise of off-state voltage	dV/dt	$T_J = T_J$ maximum, exponential to 67 % rated V_{DRM}		800	V/ μs

TRIGGERING					
PARAMETER	SYMBOL	TEST CONDITIONS		VALUES	UNITS
Maximum peak gate power	P_{GM}	$t_p \leq 5 \text{ ms}$, $T_J = T_J \text{ maximum}$		10	W
Maximum average gate power	$P_{G(AV)}$	$f = 50 \text{ Hz}$, $T_J = T_J \text{ maximum}$		3	
Maximum peak gate current	I_{GM}	$t_p \leq 5 \text{ ms}$, $T_J = T_J \text{ maximum}$		3	A
Maximum peak negative gate voltage	$-V_{GT}$			10	V
Maximum required DC gate voltage to trigger	V_{GT}	$T_J = 25^\circ\text{C}$	Anode supply = 12 V, resistive load; $R_a = 1\ \Omega$	2	mA
Maximum required DC gate current to trigger	I_{GT}			50 to 200	
Maximum gate voltage that will not trigger	V_{GD}	$T_J = T_J \text{ maximum}$, 67% V_{DRM} applied		0.25	V
Maximum gate current that will not trigger	I_{GD}			10	mA
Maximum rate of rise of turned-on current	di/dt	$T_J = 25^\circ\text{C}$, $I_{GM} = 1.5\text{A}$, $t_r \leq 0.5\ \mu\text{s}$		150	A/ μs

THERMAL AND MECHANICAL SPECIFICATIONS					
PARAMETER	SYMBOL	TEST CONDITIONS		VALUES	UNITS
junction operating and storage temperature range	T_J, T_{stg}			- 40 to 125	$^\circ\text{C}$
Maximum thermal resistance, junction to case per junction	R_{thJC}	DC operation		0.10	$^\circ\text{C/W}$
Typical thermal resistance, case to heatsink per module	R_{thCS}	Mounting surface, smooth , flat and greased		0.017	
Mounting torque $\pm 10\%$ IAP to heatsink, M6 busbar to IAP, M8		A mounting compound is recommended and the torque should be rechecked after a period of about 3 hours to allow for the spread of the compound.		4	N.m
				12	
Approximate weight				900	g
				31.7	oz.
Case style				MAGN-A-PAK	

Nell High Power Products

Fig.1 On-state current vs. voltage characteristics

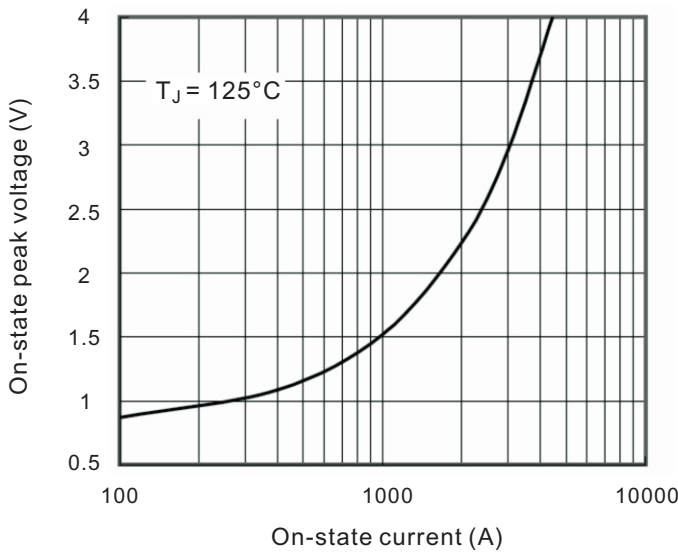

Fig.2 Transient thermal impedance(junction-case)

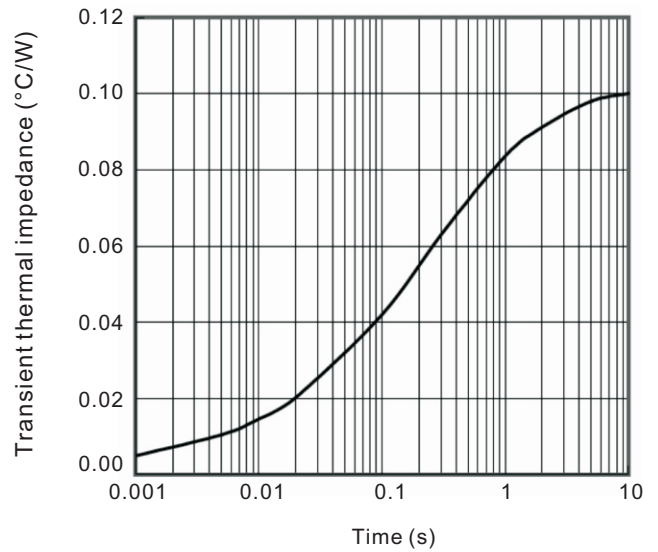

Fig.3 Power consumption vs. average current

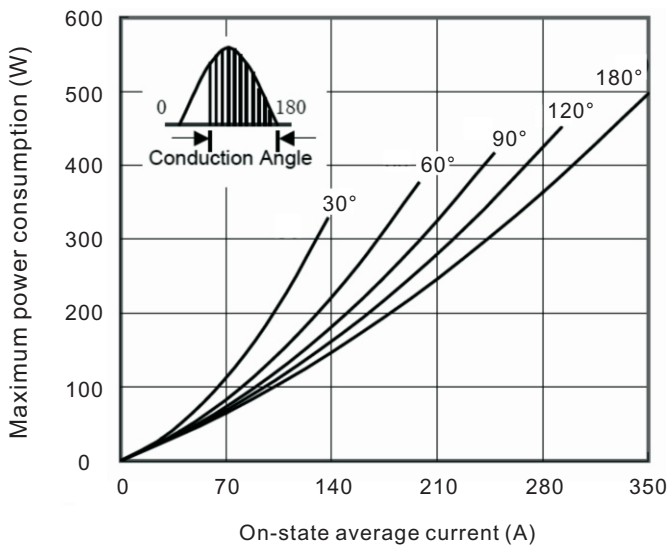

Fig.4 Case temperature vs. on-state average current

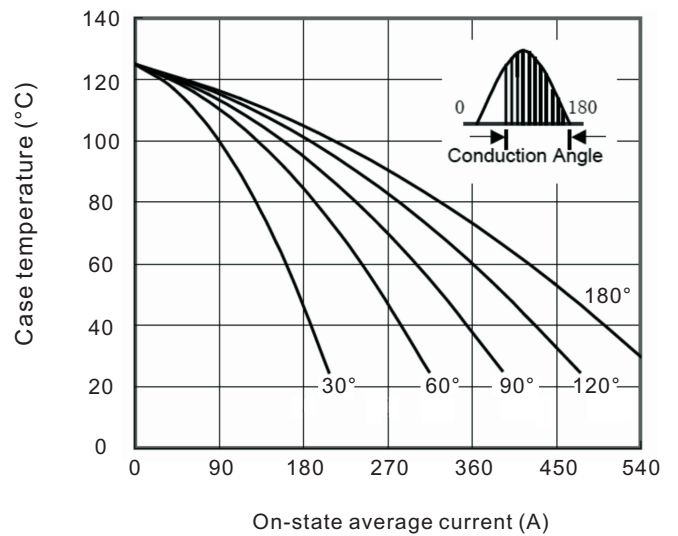

Fig.5 On-state surge current vs cycles

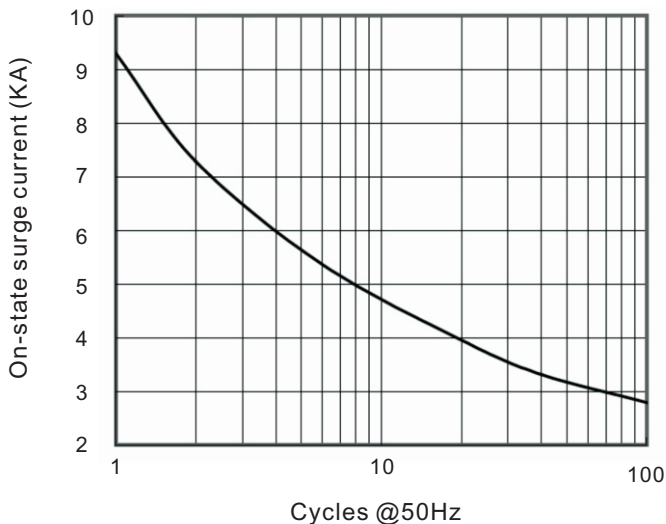

Fig.6 I^2t characteristics

