

< Silicon RF Power MOS FET (Discrete) >

# RD07MUS2B

RoHS Compliance, Silicon MOSFET Power Transistor, 175MHz, 527MHz, 870MHz, 7W

## DESCRIPTION

RD07MUS2B is a MOS FET type transistor specifically designed for VHF/UHF/870MHz RF power amplifiers applications.

## FEATURES

High power gain and High Efficiency.

Typical	Po	Gp	$\eta_D$
(175MHz)	7.2W	13.8dB	65%
(527MHz)	8W	13.0dB	63%
(870MHz)	7W	11.5dB	58%

Integrated gate protection diode.

## APPLICATION

For output stage of high power amplifiers in VHF/UHF/800MHz-band mobile radio sets.

## RoHS COMPLIANT

RD07MUS2B is a RoHS compliant product. RoHS compliance is indicating by the letter "G" after the Lot Marking. This product includes the lead in high melting temperature type solders. However, it is applicable to the following exceptions of RoHS Directions.

1. Lead in high melting temperature type solders (i.e. tin-lead solder alloys containing more than 85% lead.)

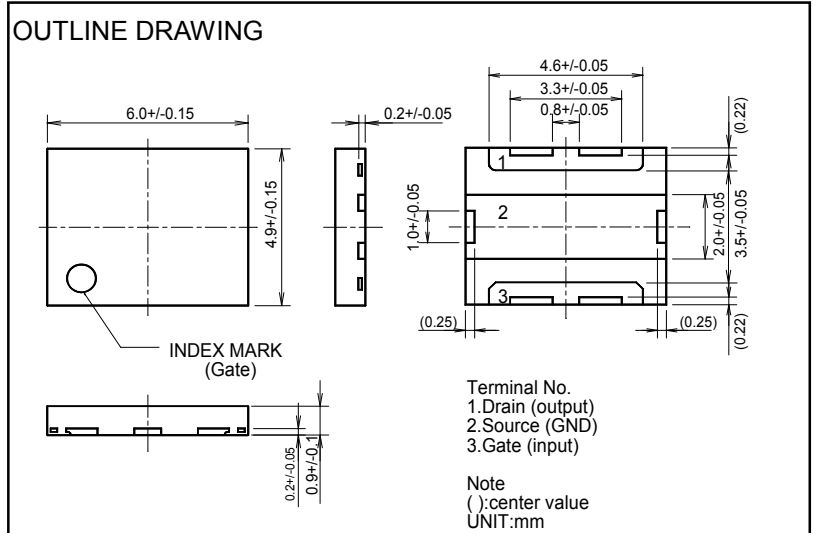

## ABSOLUTE MAXIMUM RATINGS (Tc=25°C UNLESS OTHERWISE NOTED)

SYMBOL	PARAMETER	CONDITIONS	RATINGS	UNIT
VDSS	Drain to source voltage	Vgs=0V	25	V
VGSS	Gate to source voltage	Vds=0V	-5/+10	V
Pch	Channel dissipation	Tc=25°C	50	W
Pin	Input Power	Zg=Zl=50Ω	0.8*	W
ID	Drain Current	-	3	A
Tch	Junction Temperature	-	150	°C
Tstg	Storage temperature	-	-40 to +125	°C
Rth j-c	Thermal resistance	Junction to case	2.5	°C/W

Note: Above parameters are guaranteed independently.

\*: 175MHz spec. is 0.6W

# RD07MUS2B

RoHS Compliance, Silicon MOSFET Power Transistor,175MHz,527MHz,870MHz,7W

## ELECTRICAL CHARACTERISTICS (T<sub>c</sub>=25°C, UNLESS OTHERWISE NOTED)

SYMBOL	PARAMETER	CONDITIONS	LIMITS			UNIT
			MIN	TYP	MAX.	
I <sub>DSS</sub>	Drain cutoff current	V <sub>DS</sub> =17V, V <sub>GS</sub> =0V	-	-	10	uA
I <sub>GSS</sub>	Gate cutoff current	V <sub>GS</sub> =5V, V <sub>DS</sub> =0V	-	-	1	uA
V <sub>TH</sub>	Gate threshold Voltage	V <sub>DS</sub> =7.2V, I <sub>DS</sub> =1mA	0.5	1	1.5	V
P <sub>out1</sub>	Output power	f=175MHz, V <sub>DD</sub> =7.2V	-	7.2*	-	W
η <sub>D1</sub>	Drain efficiency	P <sub>in</sub> =0.3W, I <sub>dq</sub> =250mA	-	65*	-	%
P <sub>out2</sub>	Output power	f=527MHz, V <sub>DD</sub> =7.2V	7**	8**	-	W
η <sub>D2</sub>	Drain efficiency	P <sub>in</sub> =0.4W, I <sub>dq</sub> =250mA	58**	63**	-	%
P <sub>out3</sub>	Output power	f=870MHz, V <sub>DD</sub> =7.2V	-	7***	-	W
η <sub>D3</sub>	Drain efficiency	P <sub>in</sub> =0.5W, I <sub>dq</sub> =250mA	-	58***	-	%
V <sub>SWRT</sub>	Load VSWR tolerance	V <sub>DD</sub> =9.5V, P <sub>o</sub> =7W(Pin Control) f=527MHz, I <sub>dq</sub> =250mA, Z <sub>g</sub> =50Ω Load VSWR=20:1(All Phase)	No destroy			-

Note: Above parameters, ratings, limits and conditions are subject to change.

\* At 135-175MHz broad matching

\*\* At 450-527MHz broad matching

\*\*\* At 763-870MHz broad matching

# RD07MUS2B

RoHS Compliance, Silicon MOSFET Power Transistor, 175MHz, 527MHz, 870MHz, 7W

## TYPICAL CHARACTERISTICS

(These are only typical curves and devices are not necessarily guaranteed at these curves.)

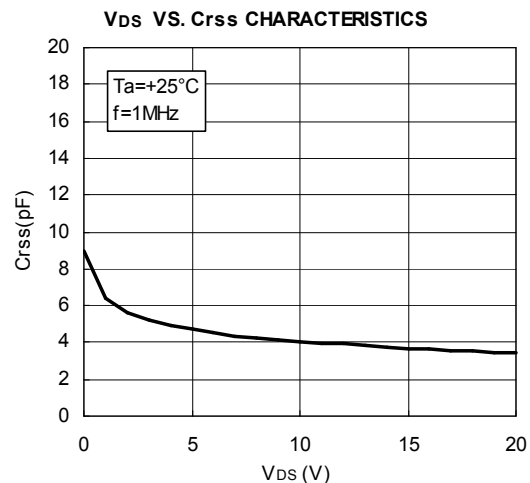
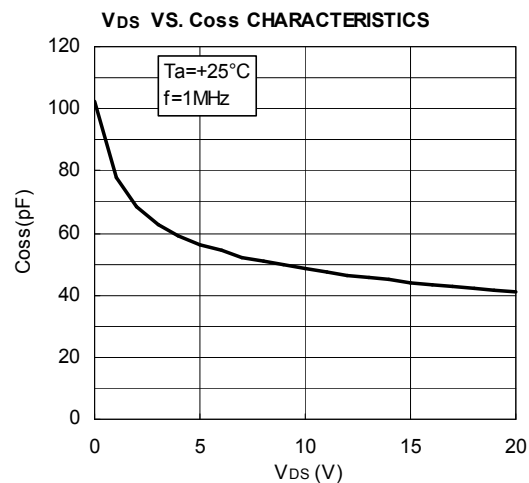
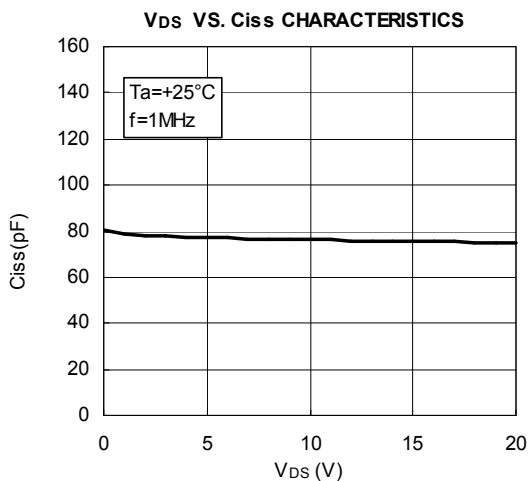
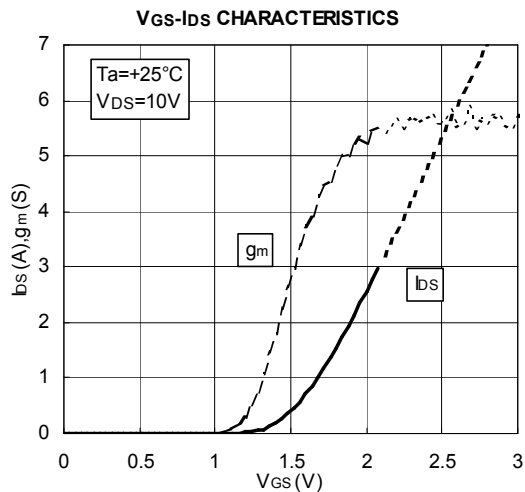
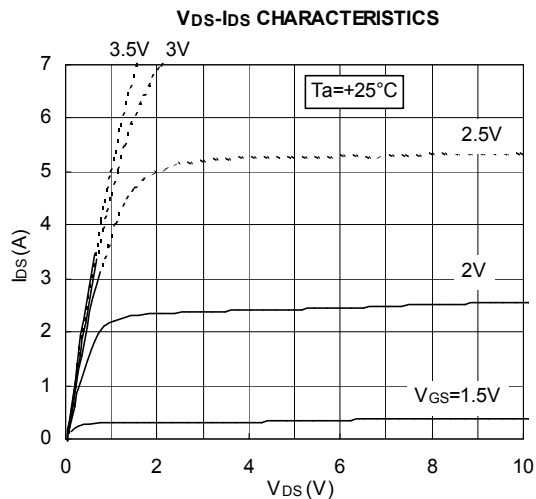

# RD07MUS2B

RoHS Compliance, Silicon MOSFET Power Transistor, 175MHz, 527MHz, 870MHz, 7W

## TYPICAL CHARACTERISTICS ( 135-175MHz )

(These are only typical curves and devices are not necessarily guaranteed at these curves.)

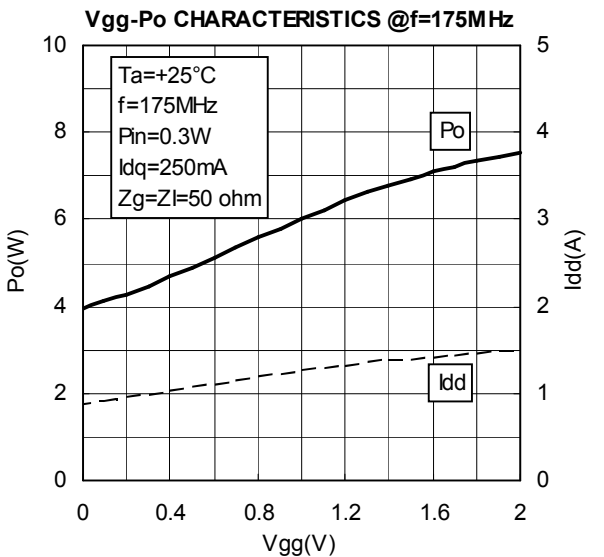
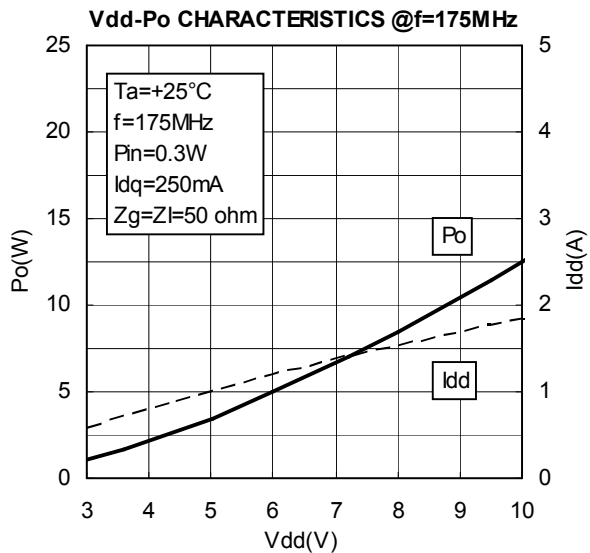
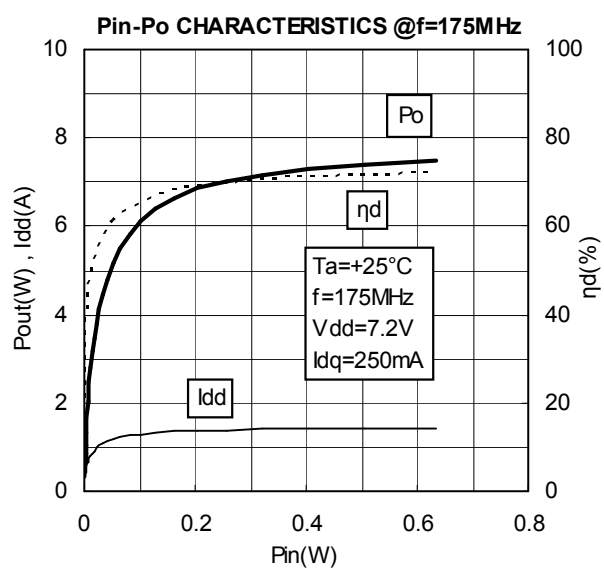
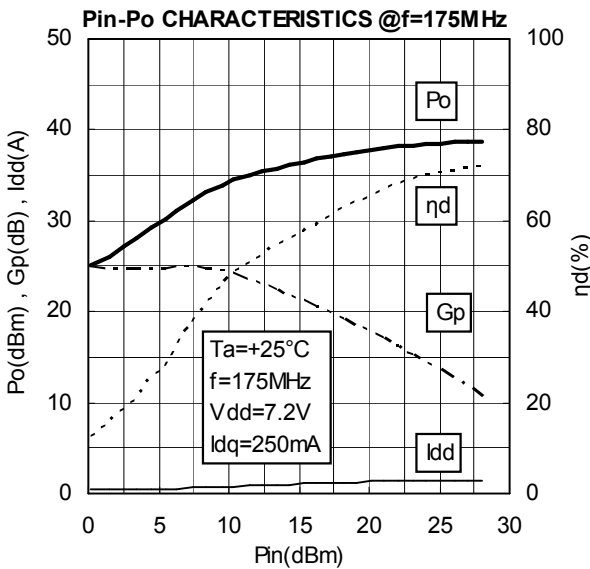
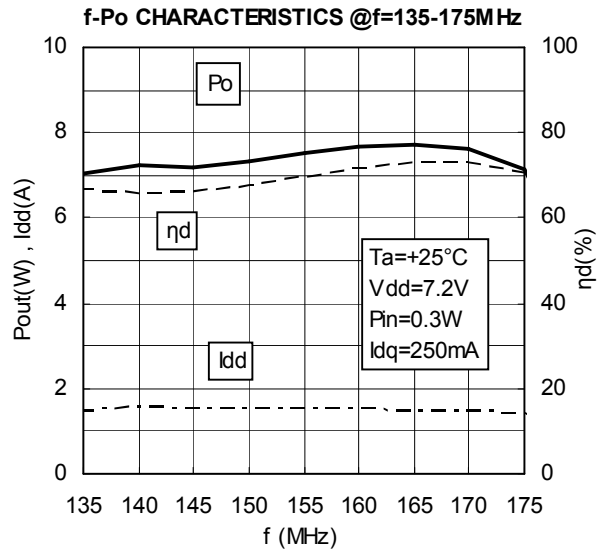
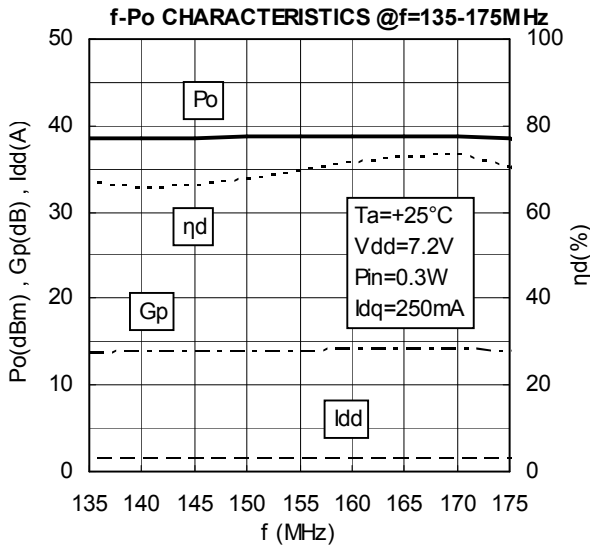

# RD07MUS2B

RoHS Compliance, Silicon MOSFET Power Transistor, 175MHz, 527MHz, 870MHz, 7W

## TYPICAL CHARACTERISTICS ( 450-527MHz )

(These are only typical curves and devices are not necessarily guaranteed at these curves.)

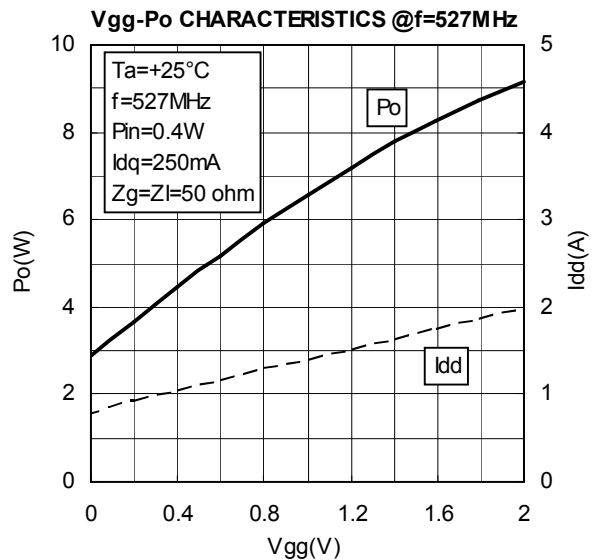
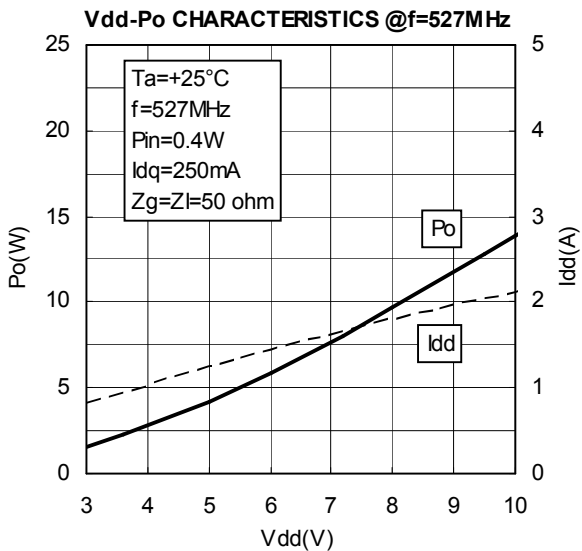
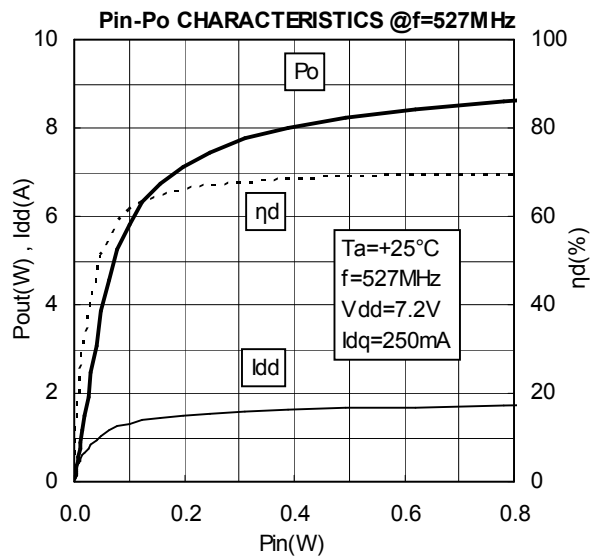
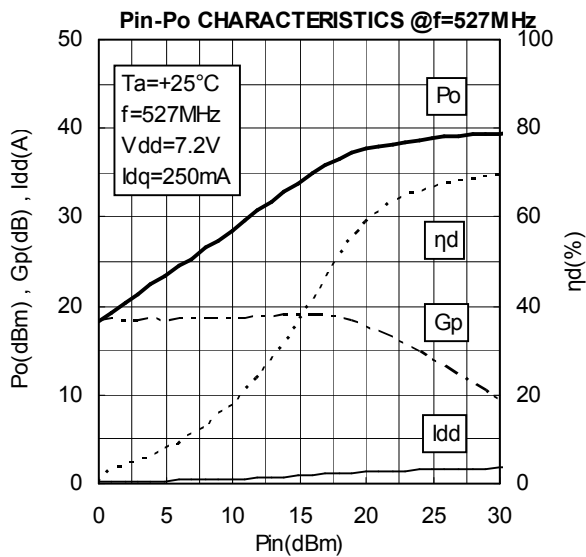
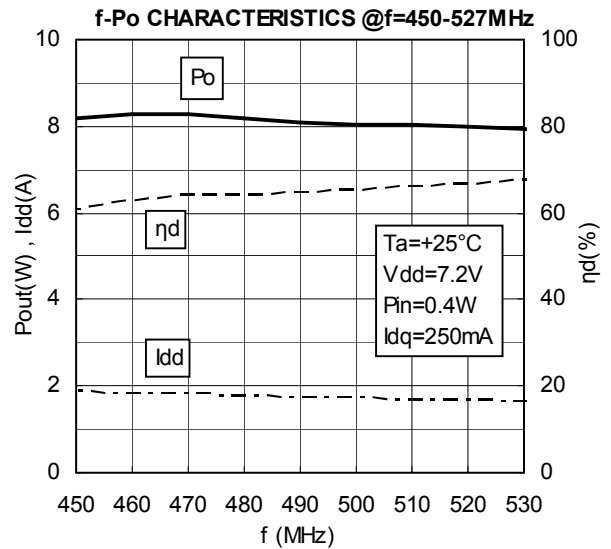
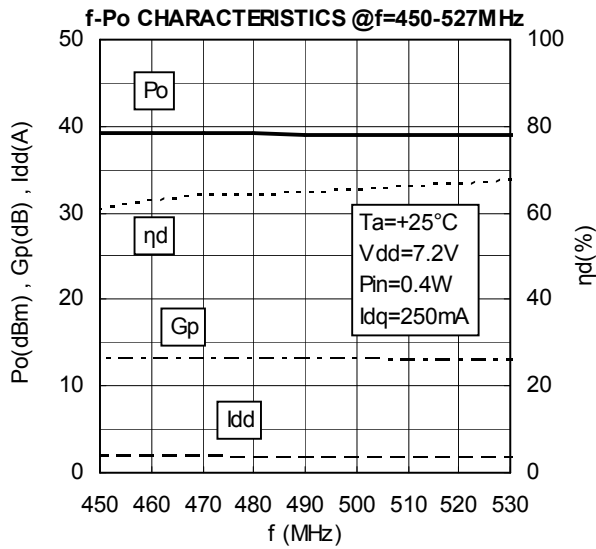

# RD07MUS2B

RoHS Compliance, Silicon MOSFET Power Transistor, 175MHz, 527MHz, 870MHz, 7W

## TYPICAL CHARACTERISTICS ( 763-870MHz )

(These are only typical curves and devices are not necessarily guaranteed at these curves.)

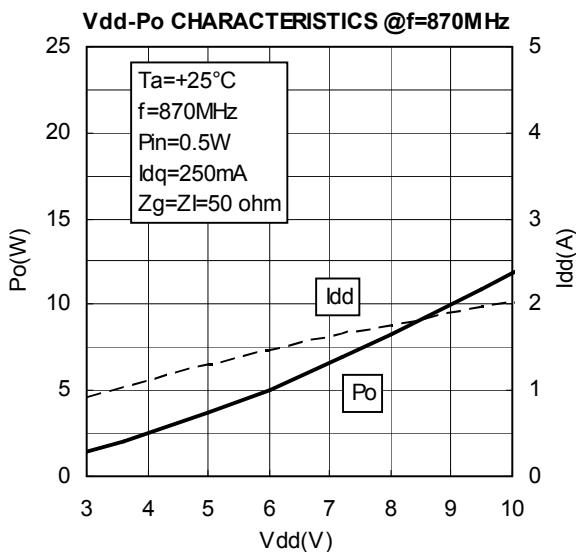
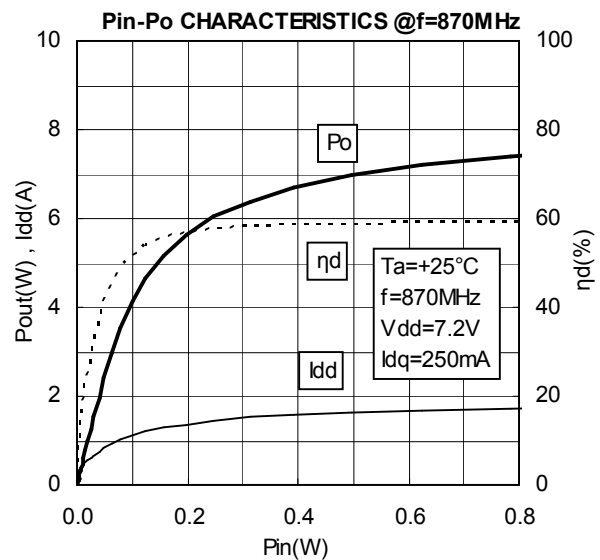
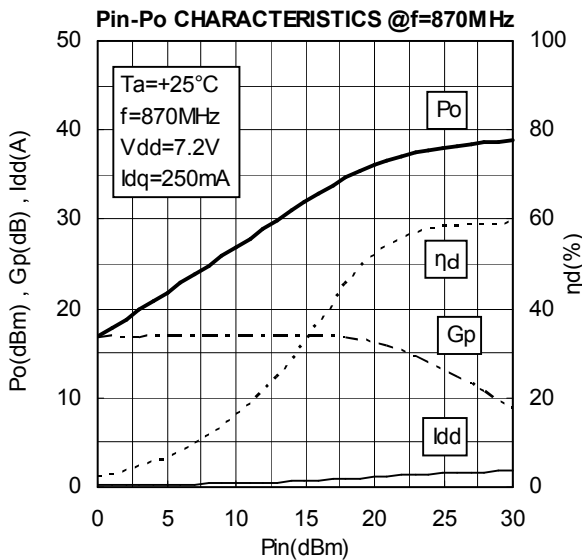
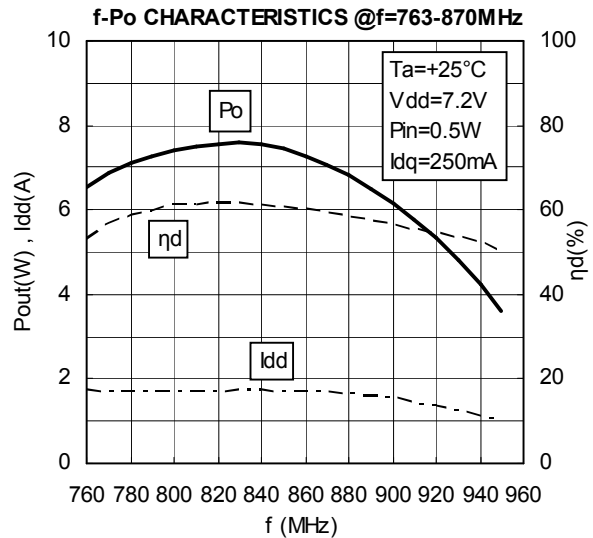
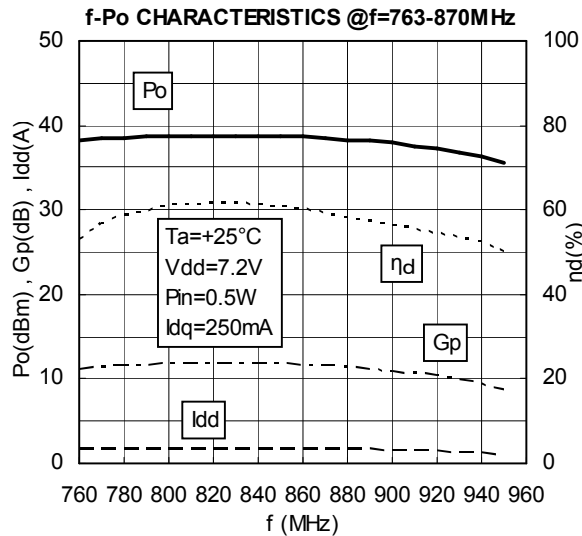

# RD07MUS2B

RoHS Compliance, Silicon MOSFET Power Transistor, 175MHz, 527MHz, 870MHz, 7W

## TYPICAL CHARACTERISTICS ( $V_{ds}=3.6V$ )

(These are only typical curves and devices are not necessarily guaranteed at these curves.)

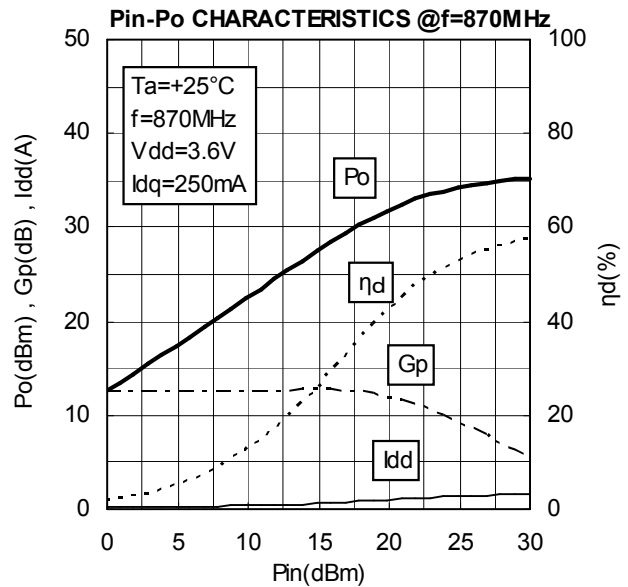
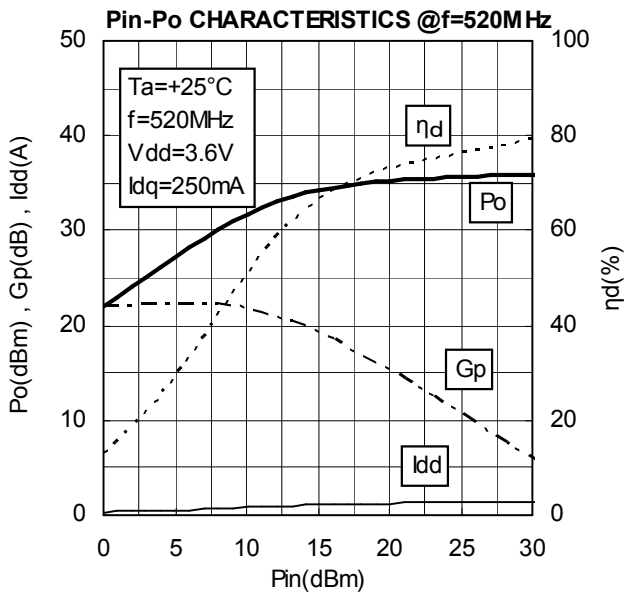
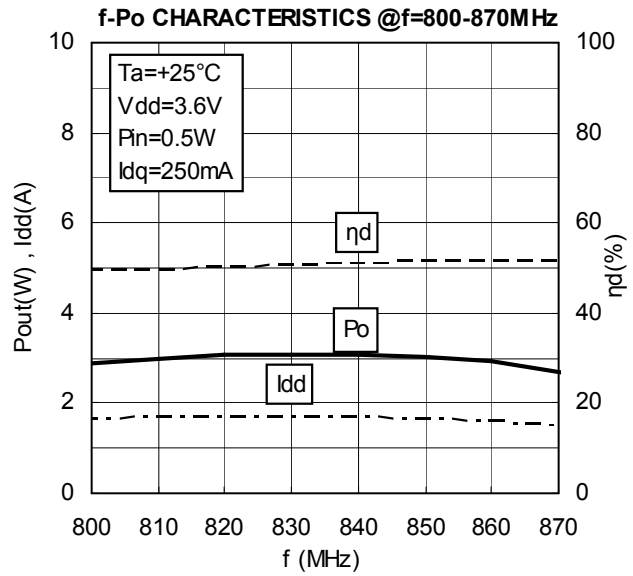
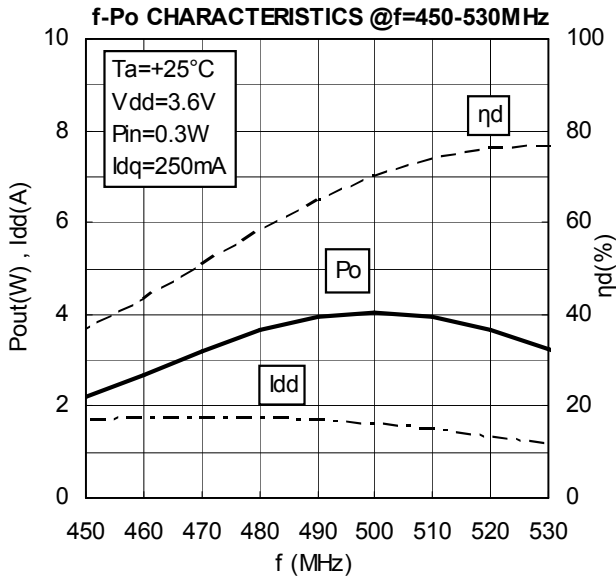

Application note : AN-900-041

The detail of this application is shown in application note.

# RD07MUS2B

RoHS Compliance, Silicon MOSFET Power Transistor, 175MHz, 527MHz, 870MHz, 7W

## TYPICAL CHARACTERISTICS ( 380-430MHz )

(These are only typical curves and devices are not necessarily guaranteed at these curves.)

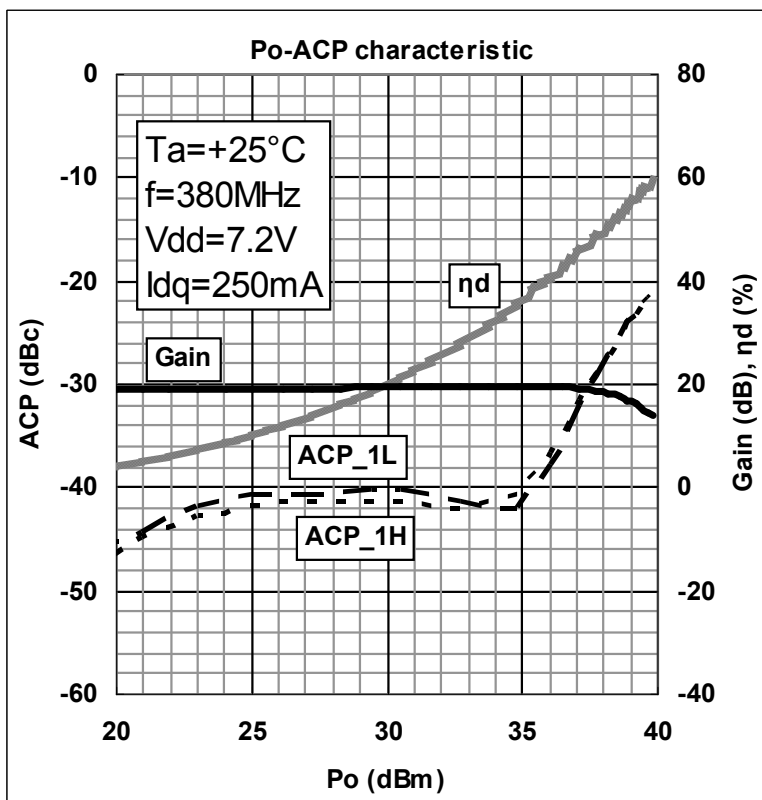
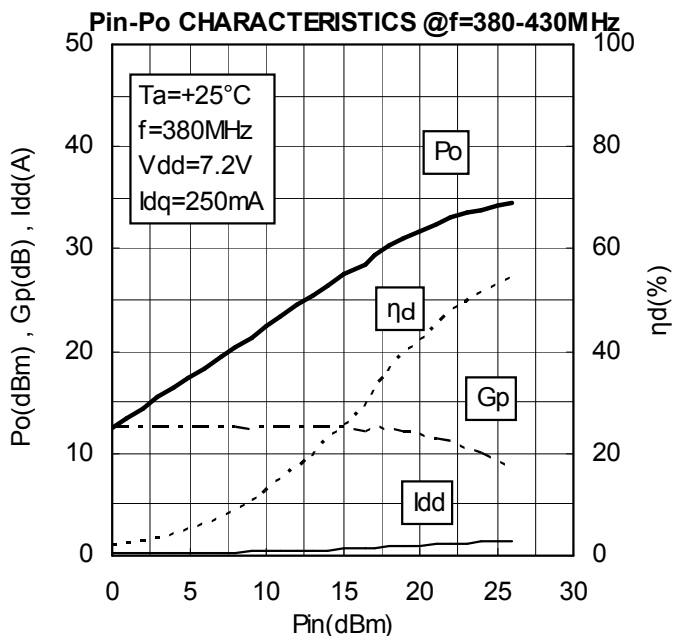

The detail of this application is shown in application note(AN-UHF-105.)



# RD07MUS2B

RoHS Compliance, Silicon MOSFET Power Transistor, 175MHz, 527MHz, 870MHz, 7W

## TEST CIRCUIT(f=135-175MHz)

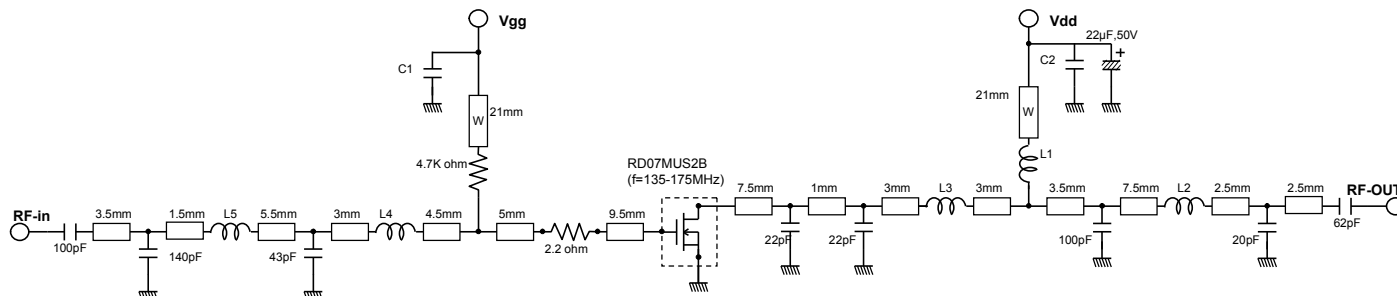

Note: Board material Glass-Epoxy substrate  
 Micro strip line width=1.3mm/50 ohm, er:4.8, t=0.8mm  
 W: line width=1.0mm

L1, L2: Enameled wire 6 Turns, D: 0.23mm, 1.66mm O.D  
 L3, L5: Enameled wire 2 Turns, D: 0.23mm, 1.66mm O.D  
 L4 : Enameled wire 4 Turns, D: 0.43mm, 1.66mm O.D  
 C1, C2: 1000pF, 0.0022μF in parallel

## TEST CIRCUIT(f=450-527MHz)

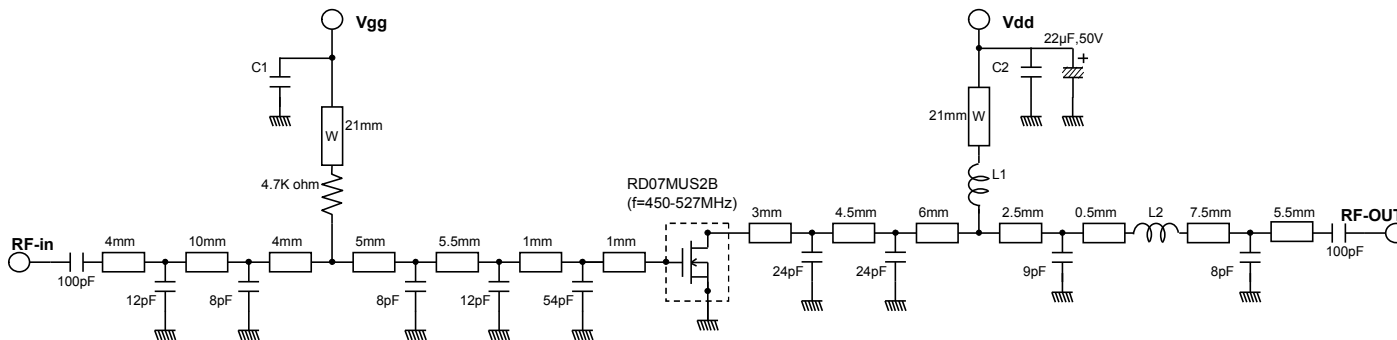

Note: Board material Glass-Epoxy substrate  
 Micro strip line width=1.3mm/50 ohm, er:4.8, t=0.8mm  
 W: line width=1.0mm

L1: Enameled wire 5 Turns, D: 0.43mm, 2.46mm O.D  
 L2: Enameled wire 2 Turns, D: 0.23mm, 1.66mm O.D  
 C1, C2: 1000pF, 0.0022μF in parallel

# RD07MUS2B

RoHS Compliance, Silicon MOSFET Power Transistor,175MHz,527MHz,870MHz,7W

## TEST CIRCUIT(f=763-870MHz)

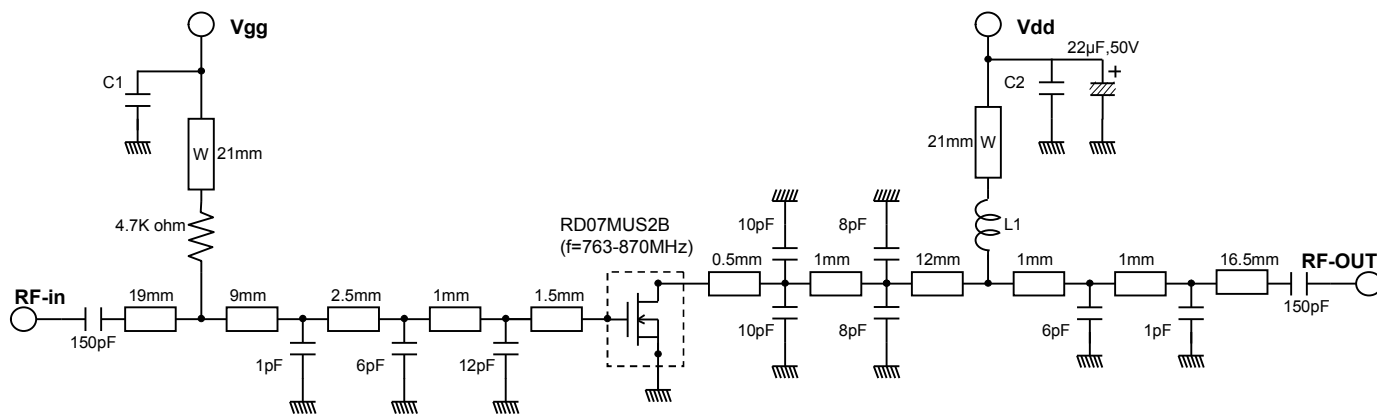

Note:Board material Glass-Epoxy substrate  
Micro strip line width=1.3mm/50 ohm,er:4.8,t=0.8mm  
W:line width=1.0mm

L1:Enameled wire 7 Turns,D:0.23mm,1.66mm O.D  
C1,C2:1000pF,100pF in parallel

# RD07MUS2B

RoHS Compliance, Silicon MOSFET Power Transistor, 175MHz, 527MHz, 870MHz, 7W

## Input / Output Impedance VS. Frequency Characteristics

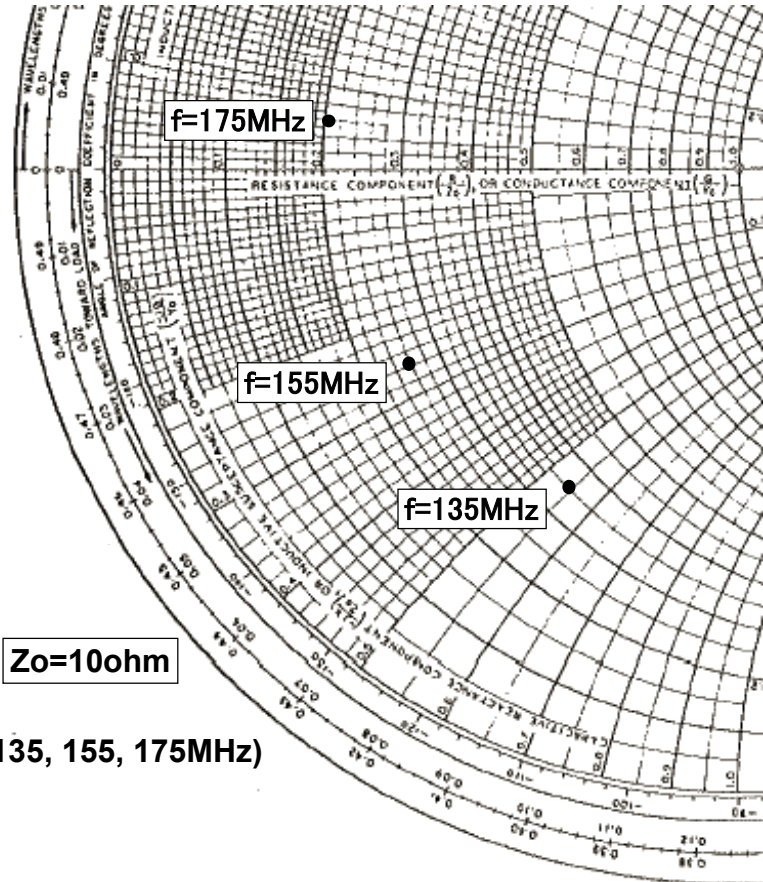

@Pin=0.3W, Vdd=7.2V,  
Idq=250mA(Vgg adj.)

f (MHz)	Zout* (ohm)
135	3.50-j5.54
155	2.57-j2.57
175	2.06+j0.62

Zo=10ohm

Zout\* ( f=135, 155, 175MHz)

Zout\*: Complex conjugate of output impedance

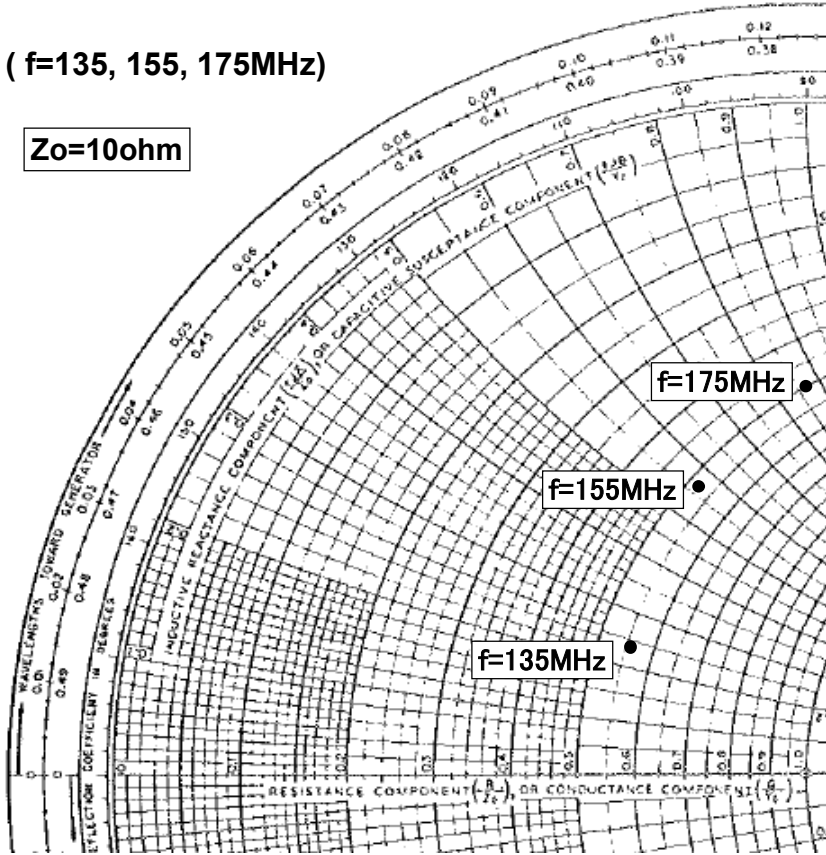

@Pin=0.3W, Vdd=7.2V,  
Idq=250mA(Vgg adj.)

f (MHz)	Zin* (ohm)
135	5.58+j2.43
155	5.25+j5.60
175	5.01+j8.65

Zo=10ohm

Zin\* ( f=135, 155, 175MHz)

Zin\*: Complex conjugate of input impedance

# RD07MUS2B

RoHS Compliance, Silicon MOSFET Power Transistor, 175MHz, 527MHz, 870MHz, 7W

## Input / Output Impedance VS. Frequency Characteristics

Zout\* ( f=450, 490, 520, 527MHz)

Zo=10ohm

@Pin=0.4W, Vdd=7.2V,  
Idq=250mA(Vgg adj.)

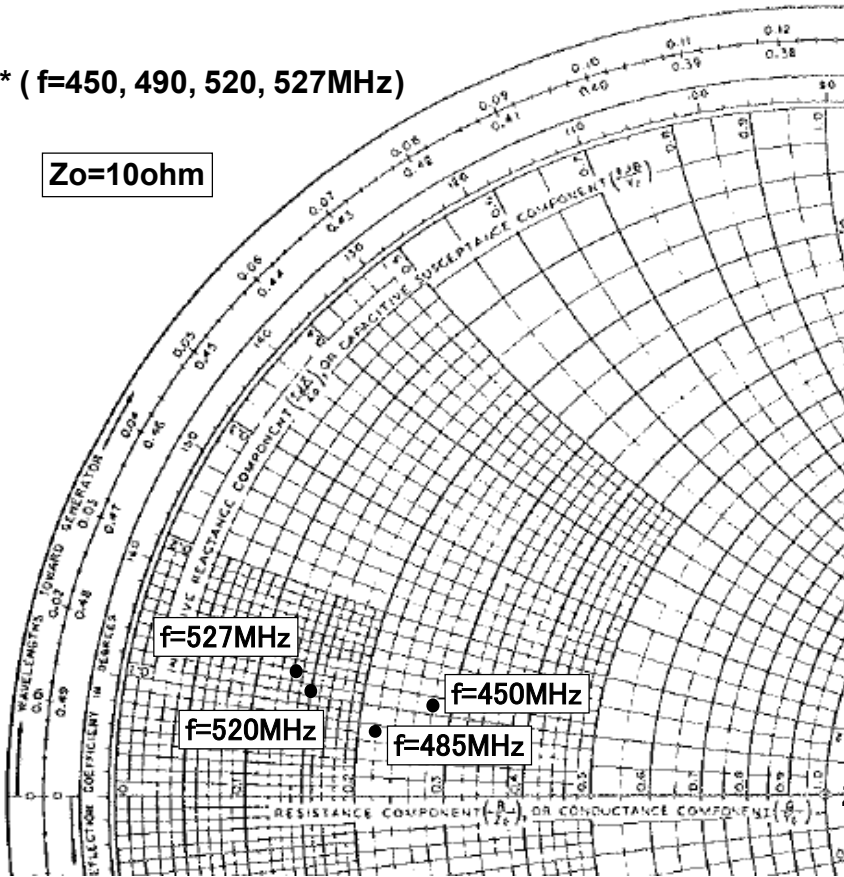

f (MHz)	Zout* (ohm)
450	2.80+j1.07
490	2.25+j0.75
520	1.51+j1.04
527	1.36+j1.20

Zout\*: Complex conjugate of output impedance

Zin\* ( f=450, 490, 520, 527MHz)

Zo=10ohm

@Pin=0.4W, Vdd=7.2V,  
Idq=250mA(Vgg adj.)

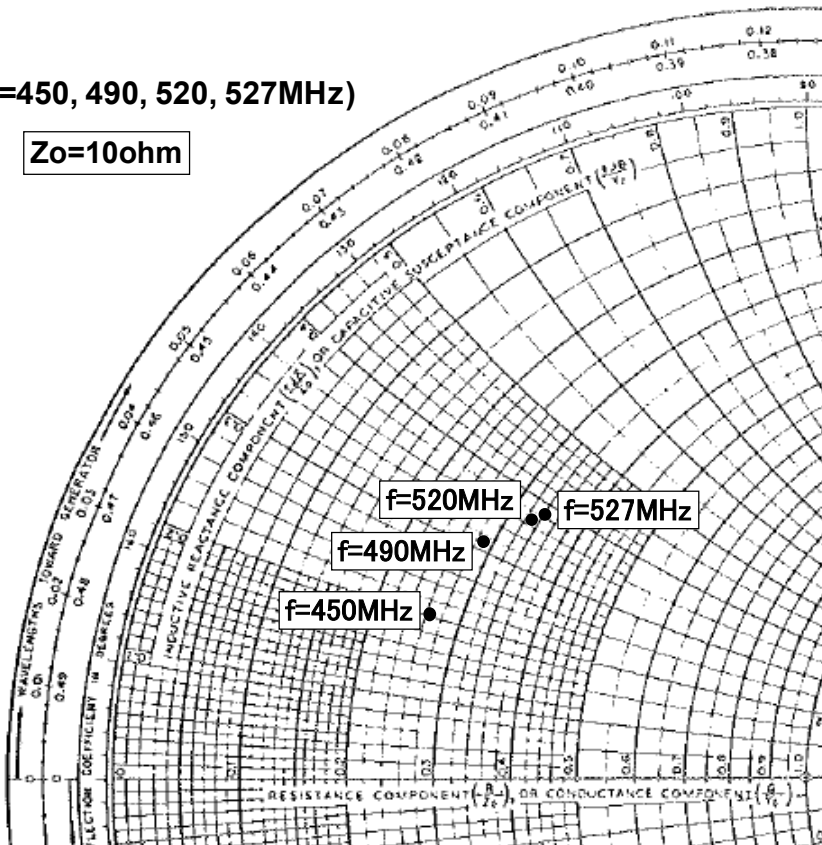

f (MHz)	Zin* (ohm)
450	2.62+j2.02
490	2.90+j3.07
520	3.29+j3.70
527	3.40+j3.81

Zin\*: Complex conjugate of input impedance

# RD07MUS2B

RoHS Compliance, Silicon MOSFET Power Transistor, 175MHz, 527MHz, 870MHz, 7W

## Input / Output Impedance VS. Frequency Characteristics

$Z_{out}^*$  ( f=763, 806, 817, 870MHz)

**Zo=10ohm**

@Pin=0.5W, Vdd=7.2V,  
Idq=250mA(Vgg adj.)

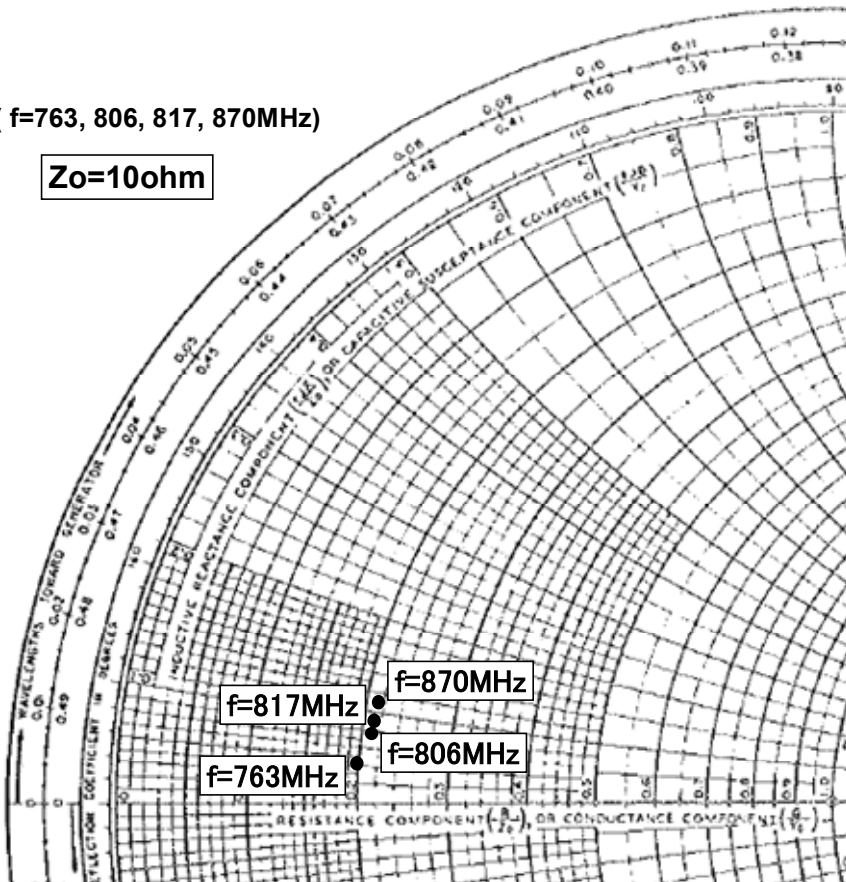

f (MHz)	Zout* (ohm)
763	2.01+j0.43
806	2.16+j0.80
817	2.17+j0.85
870	2.17+j1.07

$Z_{out}^*$ : Complex conjugate of output impedance

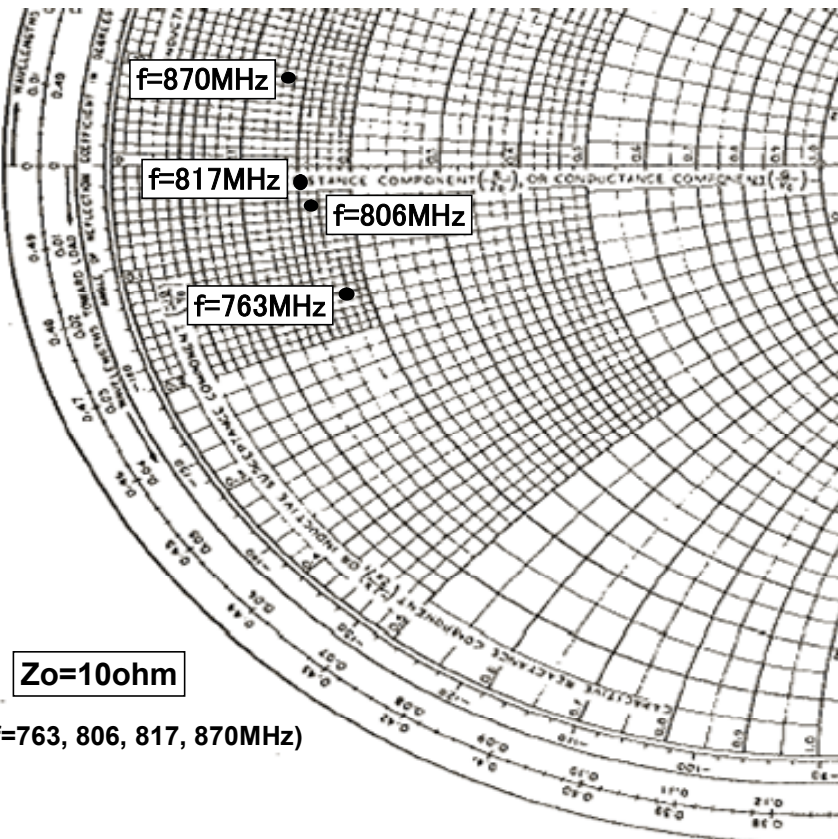

@Pin=0.5W, Vdd=7.2V,  
Idq=250mA(Vgg adj.)

f (MHz)	Zin* (ohm)
763	1.72-j1.54
806	1.55-j0.50
817	1.46-j0.23
870	1.28+j0.95

$Z_{in}^*$ : Complex conjugate of input impedance

**Zo=10ohm**

$Z_{in}^*$  ( f=763, 806, 817, 870MHz)

**RD07MUS2B**

RoHS Compliance, Silicon MOSFET Power Transistor,175MHz,527MHz,870MHz,7W

**RD07MUS2B S-PARAMETER DATA (@V<sub>dd</sub>=7.2V, I<sub>d</sub>=250mA)**

Freq. [MHz]	S11		S21		S12		S22	
	(mag)	(ang)	(mag)	(ang)	(mag)	(ang)	(mag)	(ang)
100	0.850	-170.8	10.060	79.2	0.016	-9.1	0.745	-168.8
135	0.857	-173.2	7.300	73.1	0.016	-14.2	0.759	-169.5
150	0.858	-173.7	6.509	70.7	0.015	-15.2	0.763	-170.0
175	0.863	-174.6	5.435	66.9	0.015	-18.8	0.773	-170.7
200	0.871	-175.4	4.687	63.5	0.014	-23.8	0.781	-170.6
250	0.881	-176.8	3.556	56.7	0.013	-27.4	0.806	-171.0
300	0.889	-178.1	2.791	51.2	0.013	-32.8	0.825	-171.7
350	0.903	-179.0	2.261	45.7	0.011	-36.7	0.843	-172.4
400	0.910	-180.0	1.861	40.9	0.010	-39.7	0.859	-173.2
450	0.918	178.8	1.559	36.7	0.009	-41.9	0.874	-173.9
500	0.927	177.7	1.320	33.0	0.008	-44.9	0.888	-174.5
520	0.928	177.2	1.236	31.5	0.008	-45.1	0.893	-174.8
527	0.929	177.2	1.212	31.2	0.008	-44.2	0.894	-174.9
550	0.931	176.7	1.130	29.5	0.008	-46.4	0.896	-175.4
600	0.934	175.6	0.974	26.5	0.007	-46.4	0.909	-176.0
650	0.940	174.4	0.848	23.4	0.006	-48.0	0.915	-176.5
700	0.943	173.5	0.745	20.9	0.005	-46.0	0.921	-177.4
750	0.946	172.6	0.660	18.6	0.005	-45.9	0.928	-177.8
763	0.948	172.3	0.638	18.0	0.004	-44.9	0.931	-178.0
800	0.950	171.5	0.587	16.5	0.004	-42.0	0.931	-178.3
806	0.951	171.7	0.578	16.3	0.004	-45.4	0.931	-178.3
817	0.950	171.3	0.563	15.8	0.004	-43.6	0.933	-178.6
850	0.950	170.8	0.522	14.5	0.003	-41.8	0.934	-178.8
870	0.955	170.6	0.502	13.8	0.003	-39.4	0.935	-178.9
900	0.952	170.0	0.471	12.9	0.003	-33.7	0.941	-179.2
950	0.956	169.2	0.427	11.1	0.002	-26.6	0.943	-179.5
1000	0.957	168.4	0.387	9.7	0.002	-17.3	0.943	179.9
1050	0.960	167.7	0.353	8.1	0.002	-7.4	0.949	179.7
1100	0.961	167.1	0.323	6.9	0.002	8.9	0.949	179.6

# RD07MUS2B

RoHS Compliance, Silicon MOSFET Power Transistor,175MHz,527MHz,870MHz,7W

## RD07MUS2B S-PARAMETER DATA (@Vdd=3.6V, Id=250mA)

Freq. [MHz]	S11		S21		S12		S22	
	(mag)	(ang)	(mag)	(ang)	(mag)	(ang)	(mag)	(ang)
100	0.850	-172.3	8.581	78.7	0.016	-9.3	0.782	-171.0
135	0.855	-174.2	6.239	73.0	0.016	-13.3	0.793	-171.6
150	0.856	-174.7	5.564	70.6	0.016	-17.3	0.797	-172.0
175	0.862	-175.3	4.661	66.8	0.015	-20.0	0.806	-172.5
200	0.869	-176.2	4.030	63.5	0.015	-23.1	0.812	-172.7
250	0.881	-177.4	3.057	56.8	0.014	-28.7	0.831	-173.0
300	0.887	-178.5	2.400	51.3	0.013	-32.8	0.849	-173.6
350	0.901	-179.5	1.945	46.0	0.012	-36.0	0.863	-174.3
400	0.909	179.6	1.606	41.2	0.010	-40.7	0.877	-175.0
450	0.917	178.6	1.345	37.2	0.009	-42.4	0.890	-175.5
500	0.927	177.5	1.139	33.2	0.008	-45.0	0.902	-176.2
520	0.929	177.0	1.068	31.9	0.008	-45.4	0.904	-176.3
527	0.926	176.9	1.048	31.6	0.008	-44.5	0.907	-176.4
550	0.929	176.4	0.975	29.9	0.008	-45.1	0.909	-176.9
600	0.933	175.3	0.841	26.9	0.007	-47.2	0.918	-177.4
650	0.937	174.2	0.732	23.8	0.006	-47.4	0.925	-178.0
700	0.944	173.4	0.644	21.4	0.005	-46.7	0.931	-178.6
750	0.945	172.5	0.571	19.2	0.005	-44.2	0.935	-179.0
763	0.947	172.2	0.552	18.4	0.005	-44.2	0.939	-179.1
800	0.949	171.6	0.508	17.0	0.004	-43.7	0.938	-179.3
806	0.949	171.5	0.502	16.8	0.004	-42.8	0.938	-179.5
817	0.951	171.4	0.488	16.2	0.004	-42.3	0.940	-179.6
850	0.949	170.8	0.454	15.0	0.003	-40.8	0.941	-179.8
870	0.953	170.5	0.436	14.3	0.003	-37.7	0.940	-180.0
900	0.952	169.9	0.408	13.3	0.003	-32.1	0.946	179.8
950	0.957	169.2	0.370	11.8	0.003	-25.2	0.949	179.5
1000	0.959	168.2	0.335	10.3	0.002	-18.0	0.949	179.0
1050	0.960	167.7	0.306	8.6	0.002	-6.7	0.955	178.8
1100	0.960	167.0	0.280	7.4	0.002	6.9	0.954	178.7

# RD07MUS2B

RoHS Compliance, Silicon MOSFET Power Transistor,175MHz,527MHz,870MHz,7W

## APPLICATION-NOTE

### Typical Characteristics Table (Application For Example)

(These are only typical value and devices are not necessarily guaranteed at these values.)

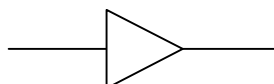

RD07MUS2B

#### Single-stage amplifier for analog radio solution

Application Note	Frequency Band	Vds	Pin	Po	Gp	$\eta_d$
AN-VHF-047	135 to 175MHz	7.2V	0.3W	7W	13.7dB	65%
AN-VHF-046	170 to 205MHz	7.2V	0.3W	7W	13.7dB	70%
AN-UHF-096	450 to 527MHz	7.2V	0.4W	7W	12.4dB	66%
AN-UHF-098	400 to 470MHz	7.2V	0.4W	7W	12.5dB	60%
AN-900-039	763 to 870MHz	7.2V	0.5W	6.5W	11.1dB	53%

#### Single-stage amplifier for digital radio solution

Application Note	Frequency Band	Vds	Pin	Po	Gp	$\eta_d$	ACP
AN-UHF-105	380 to 430MHz	7.2V	0.03W	3W	19.7dB	35%	-39dBc
AN-UHF-106	350 to 400MHz	7.2V	0.03W	3W	19.5dB	32%	-40dBc
AN-900-041	800 to 870MHz	3.6V	0.04W	1W	12.2dB	32%	-34dBc

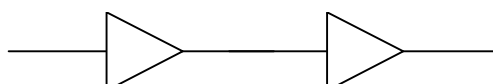

RD01MUS2  
or RD01MUS1

RD07MUS2B

#### 2stage(RD07MUS2B with driver PA) amplifier for analog radio solution

Application Note	Frequency Band	Vds	Pin	Po	Gp	$\eta_d$
AN-VHF-053	135 to 175MHz	7.2V	0.03W	7.1W	23.7dB	47%
AN-UHF-097	400 to 470MHz	7.2V	0.03W	7W	23.6dB	55%
AN-UHF-115	450 to 530MHz	7.2V	0.03W	7.4W	23.9dB	45%
AN-900-040	763 to 870MHz	7.2V	0.03W	7.2W	23.8dB	53%

#### 2stage(RD07MUS2B with driver PA) amplifier for digital radio solution

Application Note	Frequency Band	Vds	Pin	Po	Gp	$\eta_d$	ACP
AN-UHF-116	380 to 430MHz	7.2V	0.001W	3W	34.9dB	32%	-39dBc



# RD07MUS2B

RoHS Compliance, Silicon MOSFET Power Transistor,175MHz,527MHz,870MHz,7W

---

## ATTENTION:

- 1.High Temperature ; This product might have a heat generation while operation,Please take notice that have a possibility to receive a burn to touch the operating product directly or touch the product until cold after switch off. At the near the product,do not place the combustible material that have possibilities to arise the fire.
- 2.Generation of High Frequency Power ; This product generate a high frequency power. Please take notice that do not leakage the unnecessary electric wave and use this products without cause damage for human and property per normal operation.
- 3.Before use; Before use the product,Please design the equipment in consideration of the risk for human and electric wave obstacle for equipment.

## PRECAUTIONS FOR THE USE OF MITSUBISHI SILICON RF POWER DEVICES:

1. The specifications of mention are not guarantee values in this data sheet. Please confirm additional details regarding operation of these products from the formal specification sheet. For copies of the formal specification sheets, please contact one of our sales offices.
- 2.RA series products (RF power amplifier modules) and RD series products (RF power transistors) are designed for consumer mobile communication terminals and were not specifically designed for use in other applications. In particular, while these products are highly reliable for their designed purpose, they are not manufactured under a quality assurance testing protocol that is sufficient to guarantee the level of reliability typically deemed necessary for critical communications elements and In the application, which is base station applications and fixed station applications that operate with long term continuous transmission and a higher on-off frequency during transmitting, please consider the derating, the redundancy system, appropriate setting of the maintain period and others as needed. For the reliability report which is described about predicted operating life time of Mitsubishi Silicon RF Products , please contact Mitsubishi Electric Corporation or an authorized Mitsubishi Semiconductor product distributor.
3. RD series products use MOSFET semiconductor technology. They are sensitive to ESD voltage therefore appropriate ESD precautions are required.
4. In the case of use in below than recommended frequency, there is possibility to occur that the device is deteriorated or destroyed due to the RF-swing exceed the breakdown voltage.
5. In order to maximize reliability of the equipment, it is better to keep the devices temperature low. It is recommended to utilize a sufficient sized heat-sink in conjunction with other cooling methods as needed (fan, etc.) to keep the channel temperature for RD series products lower than 120deg/C(in case of Tchmax=150deg/C) ,140deg/C(in case of Tchmax=175deg/C) under standard conditions.
6. Do not use the device at the exceeded the maximum rating condition. In case of plastic molded devices, the exceeded maximum rating condition may cause blowout, smoldering or catch fire of the molding resin due to extreme short current flow between the drain and the source of the device. These results causes in fire or injury.
7. For specific precautions regarding assembly of these products into the equipment, please refer to the supplementary items in the specification sheet.
8. Warranty for the product is void if the products protective cap (lid) is removed or if the product is modified in any way from it's original form.
9. For additional "Safety first" in your circuit design and notes regarding the materials, please refer the last page of this data sheet.
10. Please refer to the additional precautions in the formal specification sheet.

# RD07MUS2B

RoHS Compliance, Silicon MOSFET Power Transistor,175MHz,527MHz,870MHz,7W

---

## **Keep safety first in your circuit designs!**

Mitsubishi Electric Corporation puts the maximum effort into making semiconductor products better and more reliable, but there is always the possibility that trouble may occur with them. Trouble with semiconductors may lead to personal injury, fire or property damage. Remember to give due consideration to safety when making your circuit designs, with appropriate measures such as (i) placement of substitutive, auxiliary circuits, (ii) use of non-flammable material or (iii) prevention against any malfunction or mishap.

## **Notes regarding these materials**

- These materials are intended as a reference to assist our customers in the selection of the Mitsubishi semiconductor product best suited to the customer's application; they do not convey any license under any intellectual property rights, or any other rights, belonging to Mitsubishi Electric Corporation or a third party.
- Mitsubishi Electric Corporation assumes no responsibility for any damage, or infringement of any third-party's rights, originating in the use of any product data, diagrams, charts, programs, algorithms, or circuit application examples contained in these materials.
- All information contained in these materials, including product data, diagrams, charts, programs and algorithms represents information on products at the time of publication of these materials, and are subject to change by Mitsubishi Electric Corporation without notice due to product improvements or other reasons. It is therefore recommended that customers contact Mitsubishi Electric Corporation or an authorized Mitsubishi Semiconductor product distributor for the latest product information before purchasing a product listed herein.  
The information described here may contain technical inaccuracies or typographical errors. Mitsubishi Electric Corporation assumes no responsibility for any damage, liability, or other loss rising from these inaccuracies or errors.  
Please also pay attention to information published by Mitsubishi Electric Corporation by various means, including the Mitsubishi Semiconductor home page (<http://www.MitsubishiElectric.com/>).
- When using any or all of the information contained in these materials, including product data, diagrams, charts, programs, and algorithms, please be sure to evaluate all information as a total system before making a final decision on the applicability of the information and products. Mitsubishi Electric Corporation assumes no responsibility for any damage, liability or other loss resulting from the information contained herein.
- Mitsubishi Electric Corporation semiconductors are not designed or manufactured for use in a device or system that is used under circumstances in which human life is potentially at stake. Please contact Mitsubishi Electric Corporation or an authorized Mitsubishi Semiconductor product distributor when considering the use of a product contained herein for any specific purposes, such as apparatus or systems for transportation, vehicular, medical, aerospace, nuclear, or undersea repeater use.
- The prior written approval of Mitsubishi Electric Corporation is necessary to reprint or reproduce in whole or in part these materials.
- If these products or technologies are subject to the Japanese export control restrictions, they must be exported under a license from the Japanese government and cannot be imported into a country other than the approved destination.  
Any diversion or re-export contrary to the export control laws and regulations of Japan and/or the country of destination is prohibited.
- Please contact Mitsubishi Electric Corporation or an authorized Mitsubishi Semiconductor product distributor for further details on these materials or the products contained therein.