

**TOSHIBA**

TOSHIBA Original CMOS 8-Bit Microcontroller

**TLCS-870 Series**

TMP87P808NG

TMP87P808MG

TMP87P808LNG

TMP87P808LMG

Not Recommended  
for New Design

**TOSHIBA CORPORATION**

Semiconductor Company

## Document Change Notification

The purpose of this notification is to inform customers about the launch of the Pb-free version of the device. The introduction of a Pb-free replacement affects the datasheet. Please understand that this notification is intended as a temporary substitute for a revision of the datasheet.

Changes to the datasheet may include the following, though not all of them may apply to this particular device.

1. Part number

Example: TMPxxxxxF      TMPxxxxxFG

All references to the previous part number were left unchanged in body text. The new part number is indicated on the prelims pages (cover page and this notification).

2. Package code and package dimensions

Example: LQFP100-P-1414-0.50C      LQFP100-P-1414-0.50F

All references to the previous package code and package dimensions were left unchanged in body text. The new ones are indicated on the prelims pages.

3. Addition of notes on lead solderability

Now that the device is Pb-free, notes on lead solderability have been added.

4. RESTRICTIONS ON PRODUCT USE

The previous (obsolete) provision might be left unchanged on page 1 of body text. A new replacement is included on the next page.

5. Publication date of the datasheet

The publication date at the lower right corner of the prelims pages applies to the new device.

1. Part number
2. Package code and dimensions

Previous Part Number (in Body Text)	Previous Package Code (in Body Text)	New Part Number	New Package Code	OTP
TMP87P808N	P-SDIP28-400-1.78	TMP87P808NG	SDIP28-P-400-1.78	—
TMP87P808M	P-SOP28-450-1.27	TMP87P808MG	SOP28-P-450-1.27B	—
TMP87P808LN	P-SDIP28-400-1.78	TMP87P808LNG	SDIP28-P-400-1.78	—
TMP87P808LM	P-SOP28-450-1.27	TMP87P808LMG	SOP28-P-450-1.27B	—

\*: For the dimensions of the new package, see the attached Package Dimensions diagram.

### 3. Addition of notes on lead solderability

The following solderability test is conducted on the new device.

Lead solderability of Pb-free devices (with the G suffix)

Test	Test Conditions	Remark
Solderability	(1) Use of Lead (Pb) ·solder bath temperature = 230°C ·dipping time = 5 seconds ·the number of times = once ·use of R-type flux (2) Use of Lead (Pb)-Free ·solder bath temperature = 245°C ·dipping time = 5 seconds ·the number of times = once ·use of R-type flux	Leads with over 95% solder coverage till lead forming are acceptable.

### 4. RESTRICTIONS ON PRODUCT USE

The following replaces the “RESTRICTIONS ON PRODUCT USE” on page 1 of body text.

#### RESTRICTIONS ON PRODUCT USE

20070701-EN

- The information contained herein is subject to change without notice.
- TOSHIBA is continually working to improve the quality and reliability of its products. Nevertheless, semiconductor devices in general can malfunction or fail due to their inherent electrical sensitivity and vulnerability to physical stress. It is the responsibility of the buyer, when utilizing TOSHIBA products, to comply with the standards of safety in making a safe design for the entire system, and to avoid situations in which a malfunction or failure of such TOSHIBA products could cause loss of human life, bodily injury or damage to property. In developing your designs, please ensure that TOSHIBA products are used within specified operating ranges as set forth in the most recent TOSHIBA products specifications. Also, please keep in mind the precautions and conditions set forth in the “Handling Guide for Semiconductor Devices,” or “TOSHIBA Semiconductor Reliability Handbook” etc.
- The TOSHIBA products listed in this document are intended for usage in general electronics applications (computer, personal equipment, office equipment, measuring equipment, industrial robotics, domestic appliances, etc.). These TOSHIBA products are neither intended nor warranted for usage in equipment that requires extraordinarily high quality and/or reliability or a malfunction or failure of which may cause loss of human life or bodily injury (“Unintended Usage”). Unintended Usage include atomic energy control instruments, airplane or spaceship instruments, transportation instruments, traffic signal instruments, combustion control instruments, medical instruments, all types of safety devices, etc.. Unintended Usage of TOSHIBA products listed in his document shall be made at the customer’s own risk.
- The products described in this document shall not be used or embedded to any downstream products of which manufacture, use and/or sale are prohibited under any applicable laws and regulations.
- The information contained herein is presented only as a guide for the applications of our products. No responsibility is assumed by TOSHIBA for any infringements of patents or other rights of the third parties which may result from its use. No license is granted by implication or otherwise under any patents or other rights of TOSHIBA or the third parties.
- Please contact your sales representative for product-by-product details in this document regarding RoHS compatibility. Please use these products in this document in compliance with all applicable laws and regulations that regulate the inclusion or use of controlled substances. Toshiba assumes no liability for damage or losses occurring as a result of noncompliance with applicable laws and regulations.
- For a discussion of how the reliability of microcontrollers can be predicted, please refer to Section 1.3 of the chapter entitled Quality and Reliability Assurance/Handling Precautions.

5. Publication date of the datasheet

The publication date of this datasheet is printed at the lower right corner of this notification.

Not Recommended  
for New Design

(Annex)

Package Dimensions

SDIP28-P-400-1.78

Unit: mm

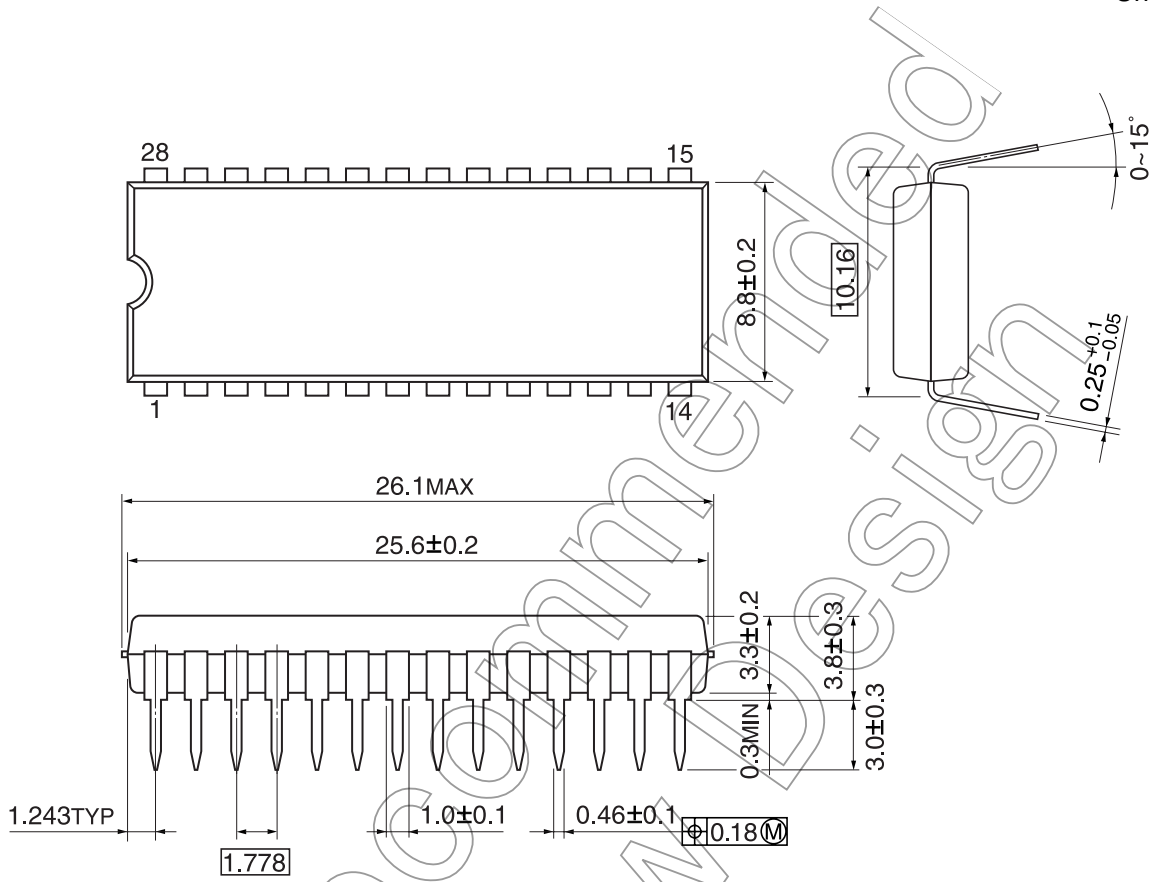

Not Recommended for New Design

SOP28-P-450-1.27B

Unit: mm

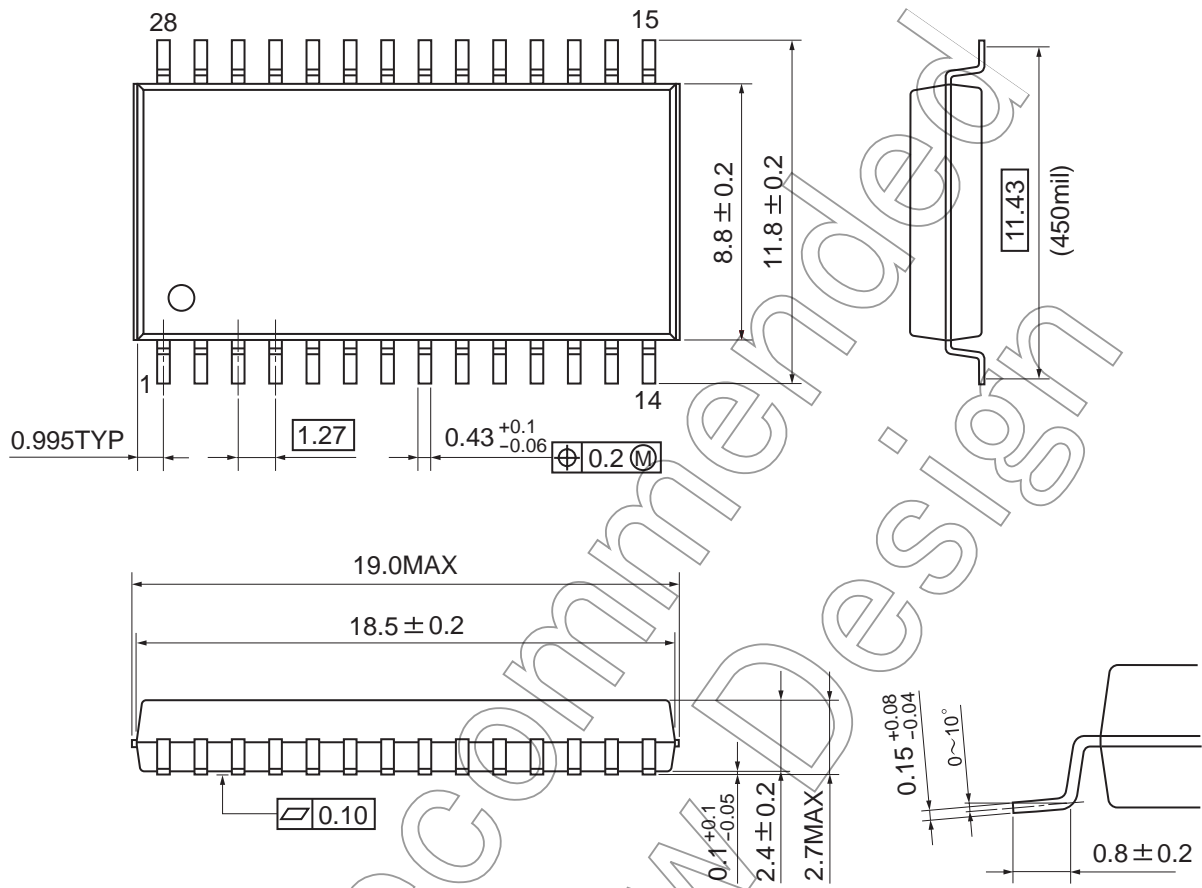

Note: Palladium plated

Not Recommended for New Design

CMOS 8-Bit Microcontroller

**TMP87P808M, TMP87P808N  
TMP87P808LM, TMP87P808LN**

The 87P808/808L is a high-speed, high-performance 8-bit single chip microcomputer, which has 64K bits One-Time PROM. The 87P808/808L is pin compatible with the 87C408/808/408L/808L. The operations possible with the 87C408/808/408L/808L can be performed by writing programs to PROM. The 87P808/808L can write and verify in the same way as the TC57256AD using an adapter socket and a general-purpose PROM programmer.

Part No.	ROM	RAM	Package	Adapter socket	Operation Voltage Range
TMP87P808M	8 K x 8-bit	256 x 8-bit	P-SOP28-450-1.27	BM11116	2.7 V to 5.5 V at 4.2 MHz
TMP87P808N			P-SDIP28-400-1.78	BM11122	4.5 V to 5.5 V at 8 MHz
TMP87P808LM			P-SOP28-450-1.27	BM11116	1.8 V to 4.0 V at 4.2 MHz
TMP87P808LN			P-SDIP28-400-1.78	BM11122	

**Pin Assignments (Top View)**

P-SOP28-400-1.78 / P-SDIP28-450-1.27

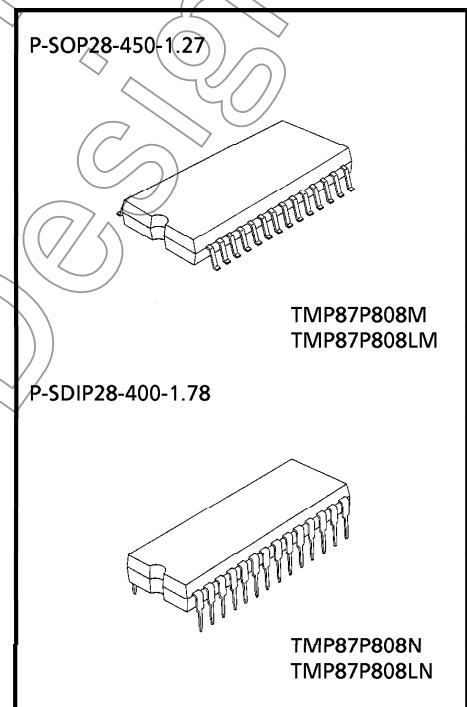
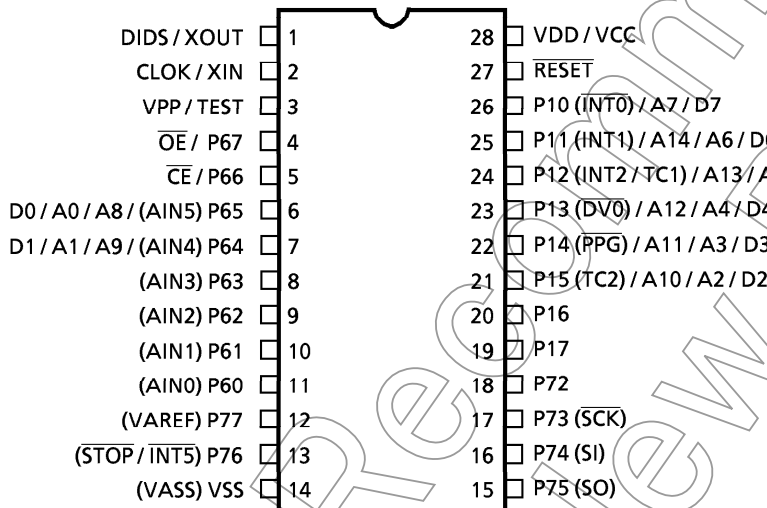

000707EBP1

- For a discussion of how the reliability of microcontrollers can be predicted, please refer to Section 1.3 of the chapter entitled Quality and Reliability Assurance / Handling Precautions.
- TOSHIBA is continually working to improve the quality and reliability of its products. Nevertheless, semiconductor devices in general can malfunction or fail due to their inherent electrical sensitivity and vulnerability to physical stress. It is the responsibility of the buyer, when utilizing TOSHIBA products, to comply with the standards of safety in making a safe design for the entire system, and to avoid situations in which a malfunction or failure of such TOSHIBA products could cause loss of human life, bodily injury or damage to property. In developing your designs, please ensure that TOSHIBA products are used within specified operating ranges as set forth in the most recent TOSHIBA products specifications. Also, please keep in mind the precautions and conditions set forth in the "Handling Guide for Semiconductor Devices," or "TOSHIBA Semiconductor Reliability Handbook" etc..
- The TOSHIBA products listed in this document are intended for usage in general electronics applications (computer, personal equipment, office equipment, measuring equipment, industrial robotics, domestic appliances, etc.). These TOSHIBA products are neither intended nor warranted for usage in equipment that requires extraordinarily high quality and/or reliability or a malfunction or failure of which may cause loss of human life or bodily injury ("Unintended Usage"). Unintended Usage include atomic energy control instruments, airplane or spaceship instruments, transportation instruments, traffic signal instruments, combustion control instruments, medical instruments, all types of safety devices, etc.. Unintended Usage of TOSHIBA products listed in this document shall be made at the customer's own risk.
- The products described in this document are subject to the foreign exchange and foreign trade laws.
- The information contained herein is presented only as a guide for the applications of our products. No responsibility is assumed by TOSHIBA CORPORATION for any infringements of intellectual property or other rights of the third parties which may result from its use. No license is granted by implication or otherwise under any intellectual property or other rights of TOSHIBA CORPORATION or others.
- The information contained herein is subject to change without notice.

**Pin Function**

The 87P808/808L has two modes: MCU and PROM.

(1) MCU mode

In this mode, the 87P808/808L is pin compatible with the 87C408/808/408L/808L (fix the TEST pin at low level).

(2) PROM mode

Pin Name (PROM mode)	Input / Output	Functions	Pin name (MCU mode)
A14 to A8	Input	Program memory address inputs	P10 to P15, P64, P65
A7 to A0			P10 to P15, P64, P65
D7 to D0	I/O	Program memory data input/outputs	P10 to P15, P64, P65
$\overline{CE}$	Input	Chip enable signal input	P66
$\overline{OE}$		Output enable signal input	P67
VPP	Power supply	+ 12.5 V / 5 V (Program supply voltage)	TEST
VCC		+ 5 V	VDD
GND		0 V	VSS
P17 to P16	I/O	PROM mode setting pins. Be fixed at low level.	
P63 to P60			
P77 to P72			
RESET			
XIN	Input	Connect an 8 MHz oscillator to stabilize the internal state.	
XOUT	Output		
VAREF	Power supply	0 V (GND)	
VASS			

Not for New Design



**Operational Description**

The configuration and function of the 87P808/808L are the same as those of the 87C408/808/408L/808L, except in that a one-time PROM is used instead of an on-chip mask ROM.

**1. Operating Mode**

The 87P808/808L has two modes: MCU and PROM.

**1.1 MCU Mode**

The MCU mode is activated by fixing the TEST/VPP pin at low level.

In the MCU mode, operation is the same as with the 87C408/808/408L/808L (TEST/VPP pin cannot be used open because it has no built in pull-down resistance.)

**1.1.1 Program Memory**

The 87P808/808L have an 8 Kbytes (addresses E000 to FFFF<sub>H</sub> in the MCU mode, addresses 6000 to 7FFF<sub>H</sub> in the PROM mode) one-time PROM.

When the 87P808/808L is used as a system evaluation of the 87C408/808/408L/808L, the data is written to the program storage area shown in Figure 1-1.

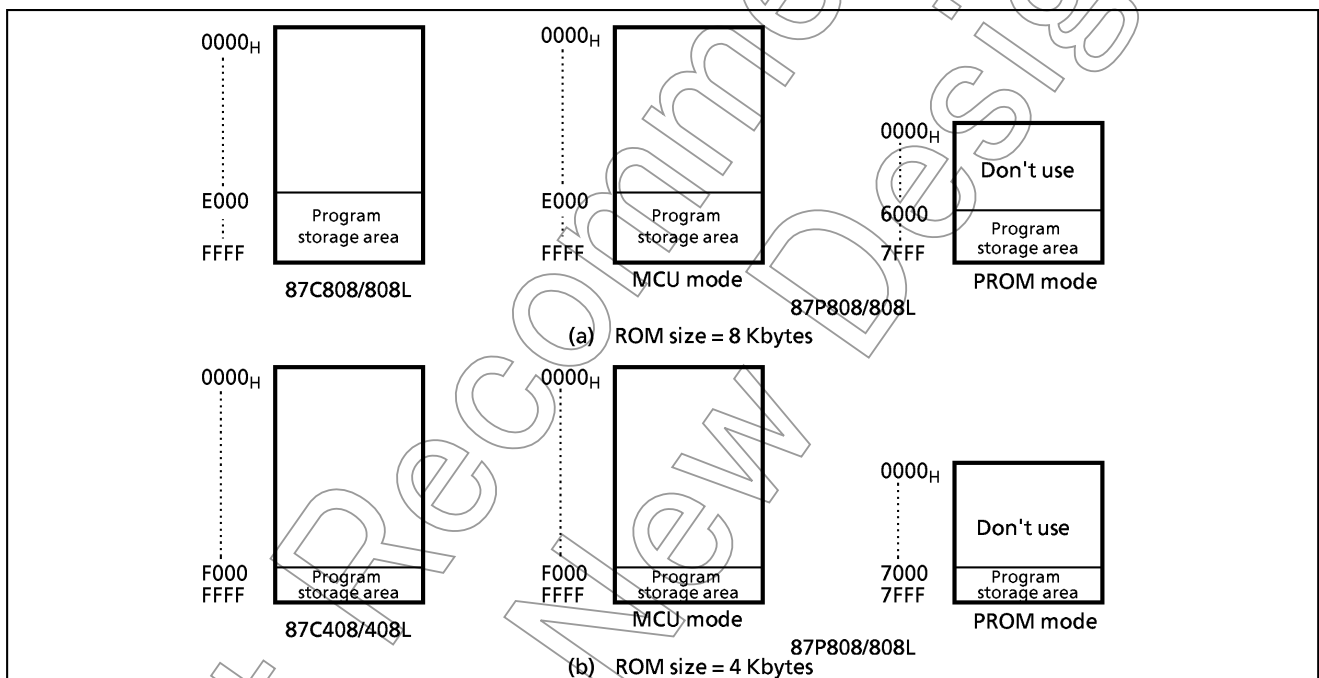

Figure 1-1. Program Memory Area

*Note: Either write the data FFH to the unused area or set the general-purpose PROM programmer to access only the program storage area*

**1.1.2 Data Memory**

The 87P808/808L has an 256 bytes data memory (static RAM).

1.1.3 Input / Output Circuits

(1) Control pins

The control pins of the 87P808/808L are the same as those of the 87C408/808/408L/808L except that the TEST pin has no built-in pull-down resistance.

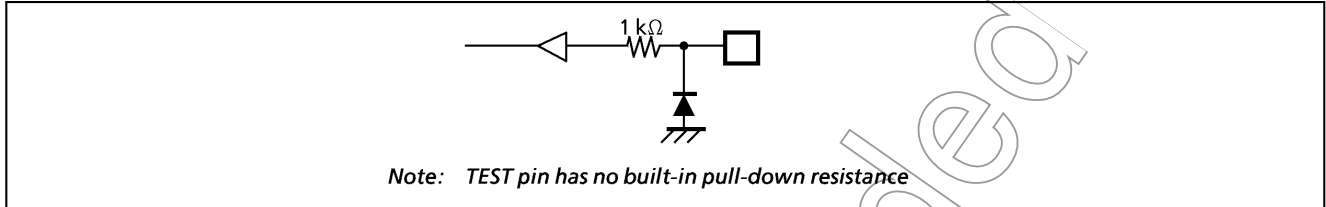

Figure 1-2. TEST Pin

(2) I/O port

The I/O circuits of 87P808/808L ports are the same as 87C408/808/408L/808L.

1.2 PROM Mode

The PROM mode is used to write and verify programs with a general-purpose PROM programmer.

*Note: The high-speed programming mode (I, II) can be used for program operation. (Please set the high-speed programming mode according to each manual of PROM programmer.) The 87P808/808L is not supported an electric signature mode.*

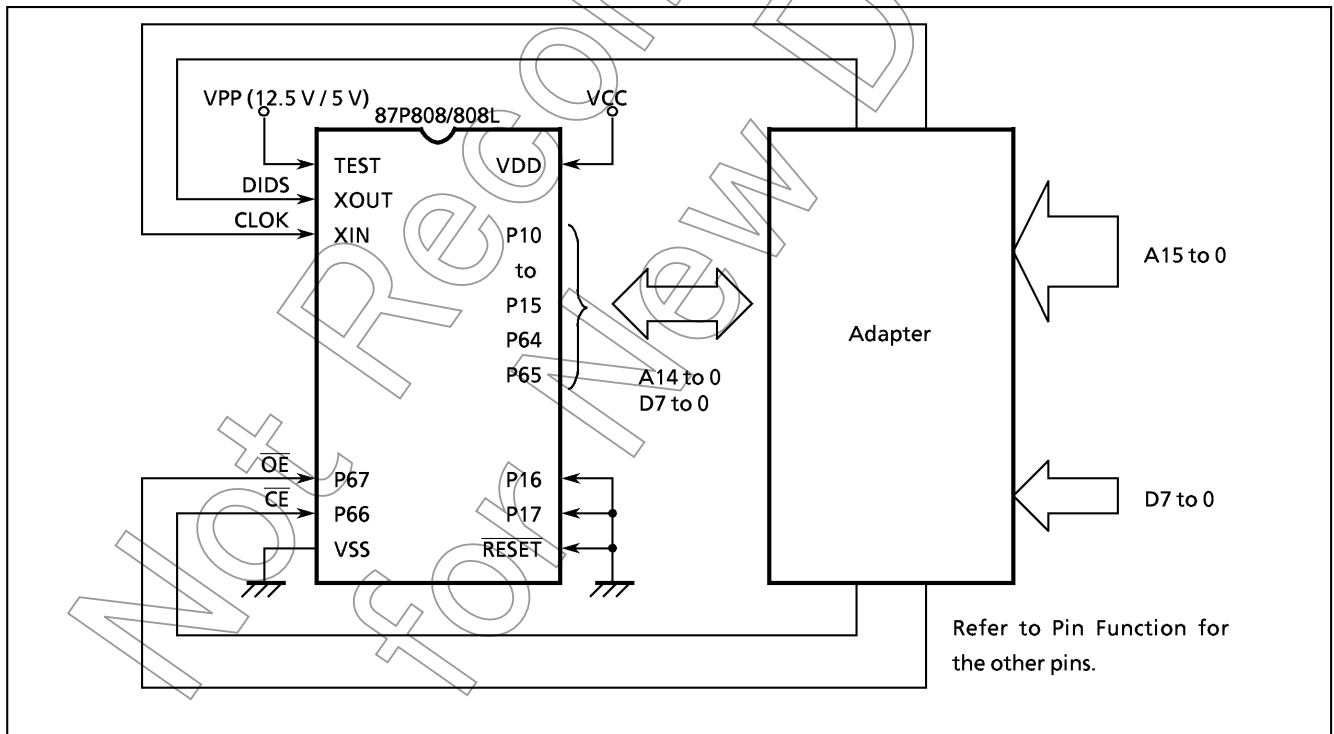

Figure 1-3. Setting for PROM Mode

**1.2.1 Programming Flowchart (High-speed Programming Mode-I)**

The high-speed programming mode is achieved by applying the program voltage (+ 12.5 V) to the V<sub>pp</sub> pin when V<sub>cc</sub> = 6 V. After the address and input data are stable, the data is programmed by applying a single 1ms program pulse to the  $\overline{CE}$  input. The programmed data is verified. If incorrect, another 1ms program pulse is applied and then the programmed data is verified. This process should be repeated (up to 25 times) until the program operates correctly. Programming for one address is ended by applying additional program pulse with width 3 times that needed for initial programming (number of programmed times × 1 ms). After that, change the address and input data, and program as before. When programming has been completed, the data in all addresses should be verified with V<sub>cc</sub> = V<sub>pp</sub> = 5 V.

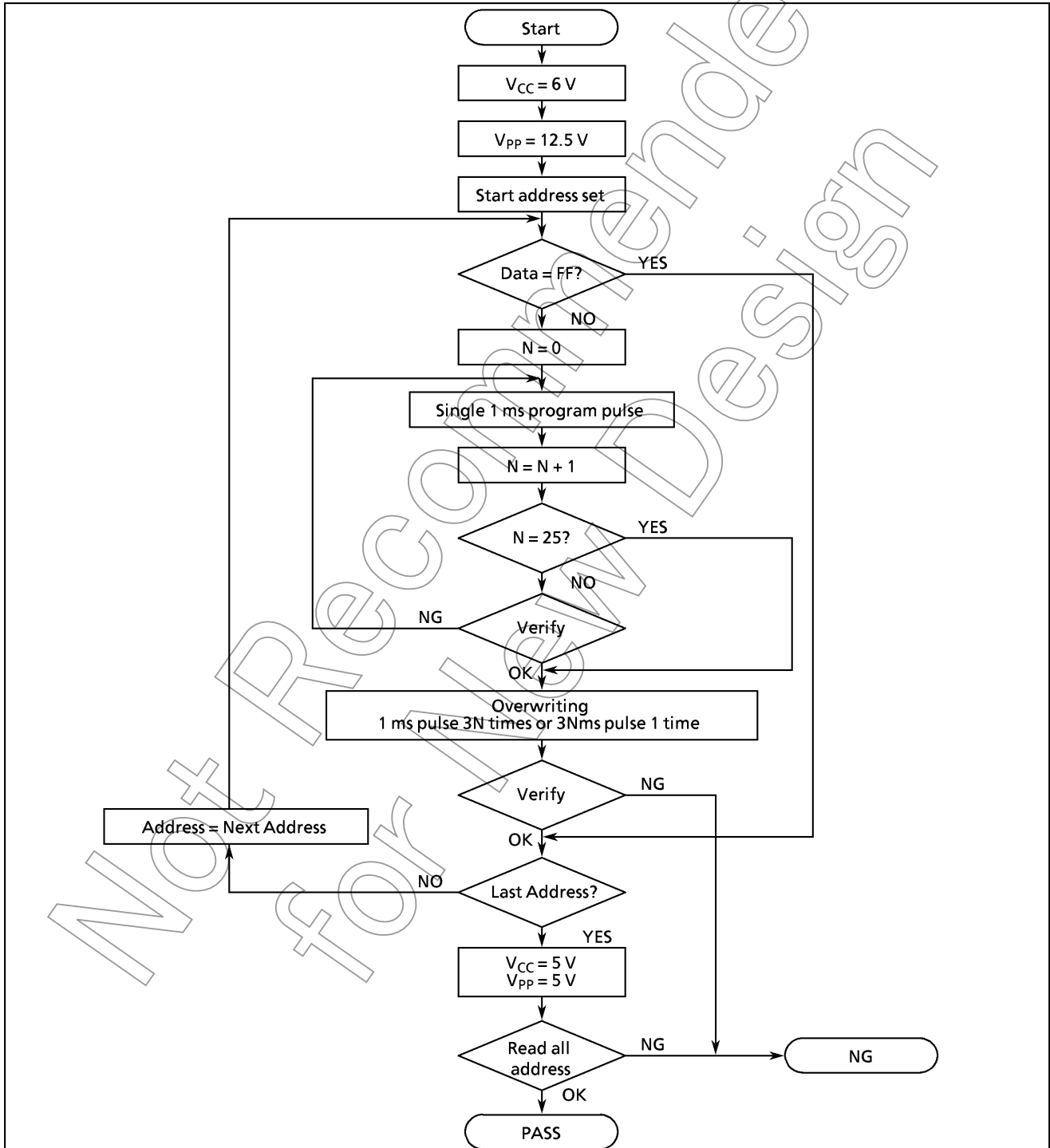

Figure 1-4. Flowchart of High-speed Programming Mode - I

**1.2.2 Programming Flowchart (High-speed Programming Mode-II)**

The high-speed programming mode is achieved by applying the program voltage (+ 12.75 V) to the V<sub>pp</sub> pin when V<sub>cc</sub> = 6.25 V. After the address and input data are stable, the data is programmed by applying a single 0.1ms program pulse to the CE input. The programmed data is verified. If incorrect, another 0.1ms program pulse is applied and then the programmed data is verified. This process should be repeated (up to 25 times) until the program operates correctly. After that, change the address and input data, and program as before. When programming has been completed, the data in all addresses should be verified with V<sub>cc</sub> = V<sub>pp</sub> = 5 V.

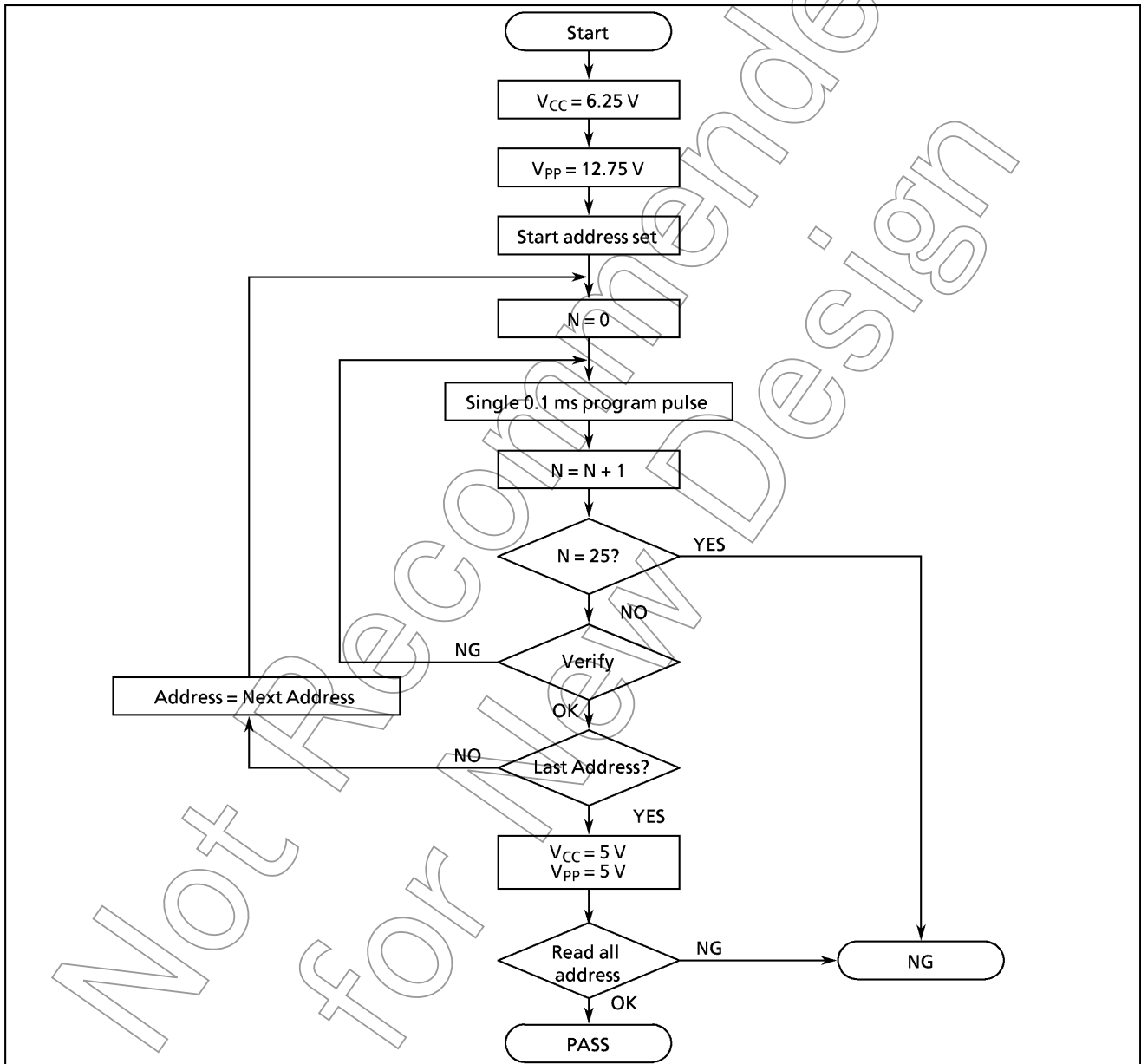

Figure 1-5. Flowchart of High-speed Programming Mode - II

### 1.2.3 Writing Method for General-purpose PROM Program

(1) Adapters

BM111116: TMP87P808M/TMP87P808LM

BM111122: TMP87P808N/TMP87P808LN

(2) Adapter setting

Switch (SW1) is set to side N.

(3) PROM programmer specifying

i) PROM type is specified to TC57256AD.

Writing voltage: 12.5 V (high-speed program I mode)  
12.75 V (high-speed program II mode)

ii) Data transfer (copy) (note 1)

In TMP87P808/808L, EPROM is within the addresses 6000 to 7FFF<sub>H</sub>. Data is required to be transferred (copied) to the addresses where it is possible to write. The program area in MCU mode and PROM mode is referred to "Program memory area" in Figure 1-1.

Ex. In the block transfer (copy) mode, executed as below.

ROM capacity of 4KB: transferred addresses F000 to FFFF<sub>H</sub> to addresses 7000 to 7FFF<sub>H</sub>

iii) Writing address is specified. (note 1)

Start address: 7000<sub>H</sub>

End address: 7FFF<sub>H</sub>

(4) Writing

Writing/Verifying is required to be executed in accordance with PROM programmer operating procedure.

*Note 1: The specifying method is referred to the PROM programmer description. The data in addresses 0000 to 5FFF<sub>H</sub> must be specified to FF<sub>H</sub>.*

*Note 2: When MCU is set to an adapter or the adapter is set to PROM programmer, a position of pin 1 must be adjusted. If the setting is reversed, MCU, the adapter and PROM program is damaged.*

*Note 3: TMP87P808/808L does not support the electric signature mode (hereinafter referred to as "signature"). If the signature is used in PROM program, a device is damaged due to applying 12 V ± 0.5 V to the address pin 9 (A9). The signature must not be used.*

Electrical Characteristics

(1) 87P808

Absolute Maximum Ratings (V<sub>SS</sub> = 0 V)

Parameter	Symbol	Conditions	Ratings	Unit	
Supply Voltage	V <sub>DD</sub>		- 0.3 to 6.5	V	
Program Voltage	V <sub>PP</sub>	TEST /V <sub>PP</sub> pin	- 0.3 to 13.0	V	
Input Voltage	V <sub>IN</sub>		- 0.3 to V <sub>DD</sub> + 0.3	V	
Output Voltage	V <sub>OUT</sub>		- 0.3 to V <sub>DD</sub> + 0.3	V	
Output Current (Per 1 pin)	IOL	I <sub>OUT1</sub>	P1, P6	3.2	mA
		I <sub>OUT2</sub>	P7 (Middle current port)	15	mA
	IOH	I <sub>OUT3</sub>	P1, P6, P7	- 1.8	mA
Output Current (Total)	IOL	∑ I <sub>OUT1</sub>	P1, P6	50	mA
		∑ I <sub>OUT2</sub>	P7 (Middle current port)	60	mA
	IOH	∑ I <sub>OUT3</sub>	P1, P6, P7	30	mA
Power Dissipation [Topr = 70°C]	PD		SDIP	300	mW
			SOP	180	
Soldering Temperature (time)	T <sub>sld</sub>		260 (10 s)	°C	
Storage Temperature	T <sub>stg</sub>		- 55 to 125	°C	
Operating Temperature	Topr		- 30 to 70	°C	

Note: The absolute maximum ratings are rated values which must not be exceeded during operation, even for an instant. Any one of the ratings must not be exceeded. If any absolute maximum rating is exceeded, a device may break down or its performance may be degraded, causing it to catch fire or explode resulting in injury to the user. Thus, when designing products which include this device, ensure that no absolute maximum rating value will ever be exceeded.

Recommended Operating Conditions (V<sub>SS</sub> = 0 V, Topr = -30 to 70°C)

Parameter	Symbol	Pins	Conditions	Min	Max	Unit	
Supply Voltage	V <sub>DD</sub>		fc = 8 MHz	NORMAL mode	4.5	5.5	V
				IDLE mode			
			fc = 4.2 MHz	NORMAL mode	2.7		
				IDLE mode			
Input High Voltage	V <sub>IH1</sub> V <sub>IH2</sub> V <sub>IH3</sub> V <sub>IH4</sub>	Except hysteresis input	V <sub>DD</sub> ≥ 4.5 V	V <sub>DD</sub> × 0.70	V <sub>DD</sub>	V	
		Hysteresis input		V <sub>DD</sub> × 0.75			
			2.7 V ≤ V <sub>D</sub> < 4.5 V	V <sub>DD</sub> × 0.90			
			V <sub>DD</sub> < 2.7 V	V <sub>DD</sub> × 0.95			
Input Low Voltage	V <sub>IL1</sub> V <sub>IL2</sub> V <sub>IL3</sub>	Except hysteresis input	V <sub>DD</sub> ≥ 4.5 V	0	V <sub>DD</sub> × 0.30	V	
		Hysteresis input		V <sub>DD</sub> × 0.25			
			2.7 V ≤ V <sub>DD</sub> < 4.5 V	V <sub>DD</sub> × 0.10			
Clock Frequency	fc	XIN, XOUT	V <sub>DD</sub> = 4.5 to 5.5 V	1.0	8.0	MHz	
			V <sub>DD</sub> = 2.7 to 5.5 V		4.2		

Note 1: The recommended operating conditions for a device are operating conditions under which it can be guaranteed that the device will operate as specified. If the device is used under operating conditions other than the recommended operating conditions (supply voltage, operating temperature range, specified AC/DC values etc.), malfunction may occur. Thus, when designing products which include this device, ensure that the recommended operating conditions for the device are always adhered to.

Note 2: Clock frequency fc: Supply voltage range is specified in NORMAL mode and IDLE mode.

Note 3: Minimum of clock frequency: 1 MHz ≤ fcgck

D.C. Characteristics

(V<sub>SS</sub> = 0 V, Topr = -30 to 70°C)

Parameter	Symbol	PINS	Conditions	Min	Typ.	Max	Unit		
Hysteresis Voltage	V <sub>HS</sub>	Hysteresis inputs		-	0.9	-	V		
Input Current	I <sub>IN1</sub>	TEST	V <sub>DD</sub> = 5.5 V V <sub>IN</sub> = 5.5 V / 0 V	-2	-	2	μA		
	I <sub>IN2</sub>	Tri-state ports							
	I <sub>IN3</sub>	RESET, STOP							
Input Resistance	R <sub>IN1</sub>	TEST	i = 2 to 5	30	70	150	kΩ		
	R <sub>IN2</sub>	RESET							
	R <sub>IN3</sub>	STOPi							
Output Leak Current	I <sub>LO</sub>	Tri-state ports	V <sub>DD</sub> = 5.5 V, V <sub>OUT</sub> = 5.5 V / 0V	-2	-	2	μA		
Output High Voltage	V <sub>OH2</sub>	Tri-state ports Ports P1, P6	V <sub>DD</sub> = 4.5 V, I <sub>OH</sub> = -0.7 mA	4.1	-	-	V		
Low Output Voltage	V <sub>OL</sub>	Except XOUT and P7	V <sub>DD</sub> = 4.5V, I <sub>OL</sub> = 1.6 mA	-	-	0.4	V		
Low Output Current	I <sub>OL3</sub>	P7	V <sub>DD</sub> = 4.5 V, V <sub>OL</sub> = 1.0 V	≥	7	-	mA		
Supply Current in NORMAL mode	I <sub>DD</sub>		V <sub>DD</sub> = 5.5 V fc = 8 MHz V <sub>IN</sub> = 5.3 V / 0.2V	fcgck	fc	-	7.0	11	mA
Supply Current in IDLE mode					fc/2	-	4.4	7.0	
					fc/4	-	2.8	5.1	
					fc/8	-	2.2	4.5	
				fc	-	3.6	5.5		
Supply Current in NORMAL mode				fcgck	fc/2	-	2.6	4.2	
					fc/4	-	2.0	3.7	
					fc/8	-	1.7	3.5	
Supply Current in IDLE mode				fcgck	fc	-	1.7	2.8	
					fc/2	-	1.1	2.0	
					fc/4	-	0.7	1.4	
Supply Current in IDLE mode				fcgck	fc	-	0.9	1.6	
	fc/2	-	0.7		1.4				
	fc/4	-	0.5		1.0				
Supply Current in STOP mode			V <sub>DD</sub> = 5.5 V V <sub>IN</sub> = 5.3 V / 0.2 V	-	0.5	10	μA		

Note 1: Typical values show those at Topr = 25°C, VDD = 5 V.

Note 2: Input Current I<sub>IN1</sub>, I<sub>IN3</sub>: The current through resistor is not included, when the input resistor (pull-up or pull-down) is contained.

Note 3: I<sub>DD</sub>; Except for I<sub>REF</sub>

A/D Conversion Characteristics

(V<sub>SS</sub> = 0 V, V<sub>DD</sub> = 2.7 to 5.5V, Topr = -30 to 70°C)

Parameter	Symbol	Conditions	Min	Typ.	Max	Unit
Analog Reference Voltage	V <sub>AREF</sub>		2.7	-	V <sub>DD</sub>	V
	V <sub>ASS</sub>		V <sub>SS</sub>			
Analog Input Voltage Range	V <sub>AIN</sub>		V <sub>ASS</sub>	-	V <sub>AREF</sub>	V
Analog Reference Current	I <sub>REF</sub>	V <sub>AREF</sub> = 5.5 V, V <sub>ASS</sub> (V <sub>SS</sub> ) = 0.0 V	-	0.8	1.0	mA
Nonlinearity Error		V <sub>DD</sub> = 5.0 V, V <sub>AREF</sub> = 5.000 V	-	-	± 1	LSB
Zero Point Error		V <sub>ASS</sub> (V <sub>SS</sub> ) = 0.000 V	-	-	± 1	
Full Scale Error		or V <sub>DD</sub> = 2.7 V, V <sub>AREF</sub> = 2.700 V	-	-	± 1	
Total Error		V <sub>ASS</sub> (V <sub>SS</sub> ) = 0.000 V	-	-	± 2	

Note: Quantizing error is not contained in those errors.

A.C. Characteristics ( I )

(V<sub>SS</sub> = 0 V, V<sub>DD</sub> = 4.5 to 5.5 V, Topr = -30 to 70°C)

Parameter	Symbol	Conditions	Min	Typ.	Max	Unit
Machine Cycle Timer	t <sub>cy</sub>	In NORMAL mode	0.5	-	4	μs
		In IDLE mode				
High Level Clock Pulse Width	t <sub>WCH</sub>	For external clock operation	50	-	-	ns
Low Level Clock Pulse Width	t <sub>WCL</sub>	f <sub>c</sub> = 8 MHz				
A/D Conversion Time	t <sub>ADC</sub>	ACK = 0	-	46	-	t <sub>cy</sub>
		ACK = 1		184		
A/D Sampling Time	t <sub>AIN</sub>		-	4	-	

A.C. Characteristics ( II )

(V<sub>SS</sub> = 0 V, V<sub>DD</sub> = 2.7 to 5.5 V, Topr = -30 to 70°C)

Parameter	Symbol	Conditions	Min	Typ.	Max	Unit
Machine Cycle Time	t <sub>cy</sub>	In NORMAL mode	0.95	-	4	μs
		In IDLE mode				
High Level Clock Pulse Width	t <sub>WCH</sub>	For external clock operation	110	-	-	ns
Low Level Clock Pulse Width	t <sub>WCL</sub>	f <sub>c</sub> = 4.2 MHz				
A/D Conversion Time	t <sub>ADC</sub>	ACK = 0	-	46	-	t <sub>cy</sub>
		ACK = 1		184		
A/D Sampling Time	t <sub>AIN</sub>		-	4	-	

Note: A/D conversion timing:  
Internal circuit for AIN0 to 5

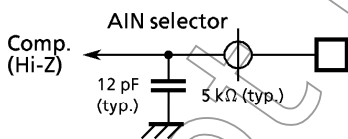

※ To maintain a precision of A/D conversion, internal condenser must be charged until t<sub>AIN</sub> is over.

A/D conversion timing

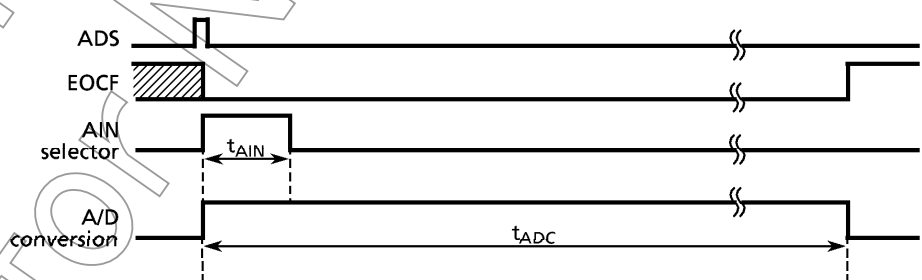



Recommended Oscillating Conditions ( I )

( $V_{SS} = 0\text{ V}$ ,  $V_{DD} = 4.5\text{ to }5.5\text{ V}$ ,  $T_{opr} = -30\text{ to }70^\circ\text{C}$ )

Parameter	Oscillator	Oscillation Frequency	Recommended Oscillator	Recommended Conditions	
				C <sub>1</sub>	C <sub>2</sub>
High-frequency Oscillation	Ceramic Resonator	8 MHz (VDD = 4.5 to 5.5 V)	KYOCERA KBR8.0M	30 pF	30 pF
			MURATA CSAC8.00MT	30 pF	30 pF
			MURATA CSA8.00MTZ/ CST8.00MTW/ CST58.00MT	—	—
		4.19 MHz (VDD = 2.7 to 5.5 V)	MURATA CSA4.19MG	30 pF	30 pF
			MURATA CST4.19MGW	—	—
		4 MHz (VDD = 2.7 to 5.5 V)	KYOCERA KBR4.0MS	30 pF	30 pF
	Crystal Oscillator	8 MHz (VDD = 4.5 to 5.5 V)	TOYOCOM 210B 8.0000	20 pF	20 pF
		4 MHz (VDD = 2.7 to 5.5 V)	TOYOCOM 204B 4.000		

Recommended Oscillating Conditions ( II )

( $V_{SS} = 0\text{ V}$ ,  $V_{DD} = 2.7\text{ to }5.5\text{ V}$ ,  $T_{opr} = -30\text{ to }70^\circ\text{C}$ )

Parameter	Oscillator	Oscillation Frequency	Recommended Oscillator	Recommended Conditions	
				C <sub>1</sub>	C <sub>2</sub>
High-frequency Oscillation	Ceramic Resonator	4.19 MHz (VDD = 2.7 to 5.5 V)	MURATA CSA4.19MG	30 pF	30 pF
			MURATA CST4.19MGW	—	—
		4 MHz (VDD = 2.7 to 5.5 V)	MURATA CSA4.00MG CSA4.00MGC	30 pF	30 pF
			MURATA CST4.00MGW CSTC4.00MG	—	—
			MURATA CSTCS4.00MG	—	—
			—	—	—

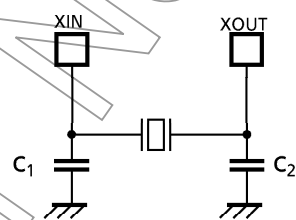

(1) High-frequency Oscillation

Note: When used in high electric field such as a picture tube, the package is recommended to be electrically shielded to maintain a regular operation.

D.C. Characteristics, A.C. Characteristics

(V<sub>SS</sub> = 0 V)

(1) Read Operation (T<sub>opr</sub> = 0 to 70°C)

Parameter	Symbol	Conditions	Min	Typ.	Max	Unit
Input High Voltage	V <sub>IH4</sub>		V <sub>CC</sub> × 0.67	–	V <sub>CC</sub>	V
Input Low Voltage	V <sub>IL4</sub>		0	–	V <sub>CC</sub> × 0.3	V
Supply Voltage	V <sub>CC</sub>		4.75	5.00	5.25	V
Program Supply Voltage	V <sub>PP</sub>		V <sub>CC</sub> – 0.6	V <sub>CC</sub>	V <sub>CC</sub> + 0.6	
Address Set-up Time	t <sub>ASU</sub>		400	–	–	ns
Address Access Time	t <sub>ACC</sub>	V <sub>CC</sub> = 5.0 ± 0.25 V	–	5tcyc	–	ns

Note: tcyc = 400 ns

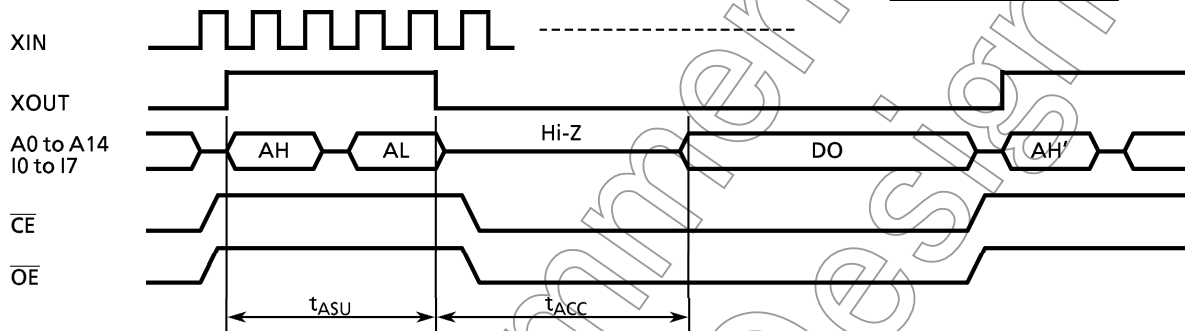

(2) Program Operation (High speed write mode - I) (T<sub>opr</sub> = 25 ± 5°C)

Parameter	Symbol	Conditions	Min	Typ.	Max	Unit
Input High Voltage	V <sub>IH4</sub>		V <sub>CC</sub> × 0.7	–	V <sub>CC</sub>	V
Input Low Voltage	V <sub>IL4</sub>		0	–	V <sub>CC</sub> × 0.12	V
Supply Voltage	V <sub>CC</sub>		5.75	6.0	6.25	V
Program Supply Voltage	V <sub>PP</sub>		12.0	12.5	13.0	V
Initial Program Pulse Width	t <sub>PW</sub>	V <sub>CC</sub> = 6.0 V ± 0.25 V, V <sub>PP</sub> = 12.5 V ± 0.25 V	0.95	1.0	1.05	ms

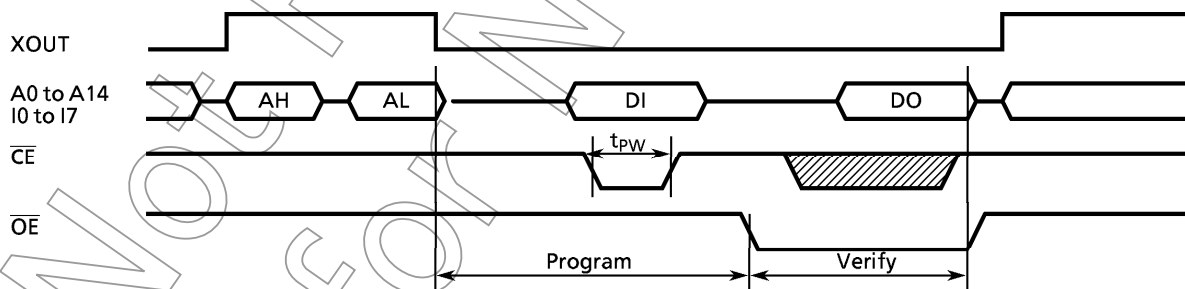

Note: DO ; Data output (I0 to I7) AL ; Address input (A0 to A7)  
DI ; Data input (I0 to I7) AH ; Address input (A8 to A14)

Note 1: When V<sub>CC</sub> power supply is turned on or after, V<sub>PP</sub> must be increased.

When V<sub>CC</sub> power supply is turned off or before, V<sub>PP</sub> must be decreased.

Note 2: The device must not be set to the EPROM programmer or picked up from it under applying the program voltage (12.5 V ± 0.5 V) to the V<sub>PP</sub> pin as the device is damaged.

Note 3: Be sure to execute the recommended programming mode with the recommended programming adaptor. If a mode or an adaptor except the above, the misoperation sometimes occurs.

(3) Program Operation (High speed write mode - II) ( $T_{opr} = 25 \pm 5^{\circ}C$ )

Parameter	Symbol	Conditions	Min	Typ.	Max	Unit
Input High Voltage	$V_{IH4}$		$V_{CC} \times 0.7$	-	$V_{CC}$	V
Input Low Voltage	$V_{IL4}$		0	-	$V_{CC} \times 0.12$	V
Supply Voltage	$V_{CC}$		6.00	6.25	6.50	V
Program Supply Voltage	$V_{PP}$		12.50	12.75	13.0	V
Initial Program Pulse Width	$t_{PW}$	$V_{CC} = 6.25 V \pm 0.25 V,$ $V_{PP} = 12.75 V \pm 0.25 V$	0.095	0.1	0.105	ms

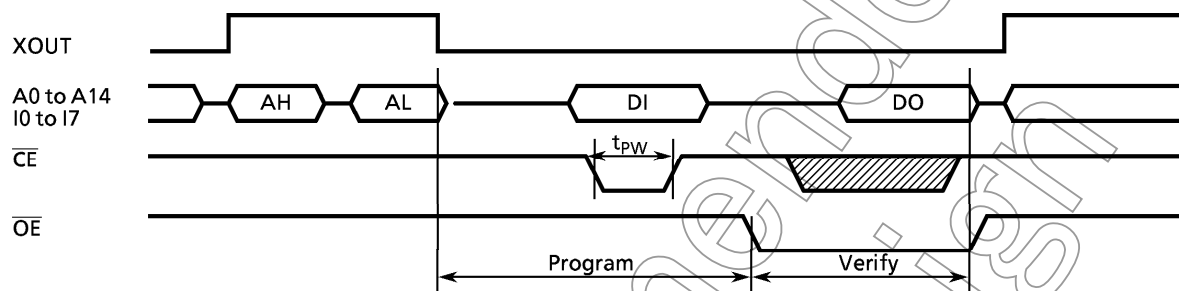

Note: DO ; Data output (I0 to I7)    AL ; Address input (A0 to A7)  
 DI ; Data input (I0 to I7)        AH ; Address input (A8 to A14)

- Note 1: When  $V_{CC}$  power supply is turned on or after,  $V_{PP}$  must be increased.  
 When  $V_{CC}$  power supply is turned off or before,  $V_{PP}$  must be decreased.
- Note 2: The device must not be set to the EPROM programmer or picked up from it under applying the program voltage ( $12.5 V \pm 0.5 V$ ) to the  $V_{PP}$  pin as the device is damaged.
- Note 3: Be sure to execute the recommended programing mode with the recommended programing adaptor. If a mode or an adaptor except the above, the misoperation sometimes occurs.

Recommended EPROM Programmer

- |           |                                |
|-----------|--------------------------------|
| DATA I/O  | UNISTTE (SITE40)               |
| ADVANTEST | R4945A                         |
| AVAL DATA | PECKER11 MARK-II (version 5.5) |

Not for new

## Electrical Characteristics

(1) 87P808L

## Absolute Maximum Ratings

 $(V_{SS} = 0\text{ V})$ 

Parameter	Symbol	Conditions	Ratings	Unit	
Supply Voltage	$V_{DD}$		-0.3 to 6.5	V	
Program Voltage	$V_{PP}$	TEST / $V_{PP}$ pin	-0.3 to 13.0	V	
Input Voltage	$V_{IN}$		-0.3 to $V_{DD} + 0.3$	V	
Output Voltage	$V_{OUT}$		-0.3 to $V_{DD} + 0.3$	V	
Output Current (Per 1 pin)	IOL	$I_{OUT1}$	P1, P6	3.2	mA
		$I_{OUT2}$	P7 (Middle current port)	15	mA
	IOL	$I_{OUT3}$	P1, P6, P7	-1.8	mA
Output Current (Total)	IOL	$\Sigma I_{OUT1}$	P1, P6	50	mA
		$\Sigma I_{OUT2}$	P7 (Middle current port)	60	mA
	IOL	$\Sigma I_{OUT3}$	P1, P6, P7	30	mA
Power Dissipation [Topr = 70°C]	PD		SDIP	300	mW
			SOP	180	
Soldering Temperature (time)	Tsld		260 (10 s)	°C	
Storage Temperature	Tstg		-55 to 125	°C	
Operating Temperature	Topr		-30 to 70	°C	

Note: The absolute maximum ratings are rated values which must not be exceeded during operation, even for an instant. Any one of the ratings must not be exceeded. If any absolute maximum rating is exceeded, a device may break down or its performance may be degraded, causing it to catch fire or explode resulting in injury to the user. Thus, when designing products which include this device, ensure that no absolute maximum rating value will ever be exceeded.

## Recommended Operating Conditions

 $(V_{SS} = 0\text{ V}, \text{Topr} = -30\text{ to }70^\circ\text{C})$ 

Parameter	Symbol	Pins	Conditions	Min	Max	Unit	
Supply Voltage	$V_{DD}$		$f_c = 4.2\text{ MHz}$	NORMAL mode	1.8	4.0	V
				IDLE mode			
			STOP mode				
Input High Voltage	$V_{IH}$			$V_{DD} \times 0.90$	$V_{DD}$	V	
Input Low Voltage	$V_{IL}$			0	$V_{DD} \times 0.10$	V	
Clock Frequency	$f_c$	XIN, XOUT	$V_{DD} = 1.8\text{ to }4.0\text{ V}$	1.0	4.2	MHz	

Note 1: The recommended operating conditions for a device are operating conditions under which it can be guaranteed that the device will operate as specified. If the device is used under operating conditions other than the recommended operating conditions (supply voltage, operating temperature range, specified AC/DC values etc.), malfunction may occur. Thus, when designing products which include this device, ensure that the recommended operating conditions for the device are always adhered to.

Note 2: Clock frequency  $f_c$ : Supply voltage range is specified in NORMAL mode and IDLE mode.

Note 3: Minimum of clock frequency:  $1\text{ MHz} \leq f_{c\text{gck}}$

D.C. Characteristics

(V<sub>SS</sub> = 0 V, Topr = -30 to 70°C)

Parameter	Symbol	PINS	Conditions	Min	Typ.	Max	Unit			
Hysteresis Voltage	V <sub>HS</sub>	Hysteresis inputs		-	0.9	-	V			
Input Current	I <sub>IN1</sub>	TEST	V <sub>DD</sub> = 4.0 V V <sub>IN</sub> = 4.0 V / 0 V	-2	-	2	μA			
	I <sub>IN2</sub>	Tri-state ports								
	I <sub>IN3</sub>	RESET, STOP								
Input Resistance	R <sub>IN1</sub>	TEST		30	70	150	kΩ			
	R <sub>IN2</sub>	RESET		100	220	450				
	R <sub>IN3</sub>	STOPi	i = 2 to 5	30	130	250				
Output Leak Current	I <sub>LO</sub>	Tri-state ports	V <sub>DD</sub> = 4.0 V, V <sub>OUT</sub> = 4.0 V / 0 V	-2	-	2	μA			
Output High Voltage	V <sub>OH2</sub>	Tri-state ports	V <sub>DD</sub> = 4.0 V, I <sub>OH</sub> = -0.5 mA	3.6	-	-	V			
Output Low Voltage	V <sub>OL</sub>	Except XOUT and P7	V <sub>DD</sub> = 4.0 V, I <sub>OL</sub> = 1.3 mA	-	-	0.4	V			
Output Low Current	I <sub>OL3</sub>	P7	V <sub>DD</sub> = 4.0 V, V <sub>OL</sub> = 1.0 V	≥	6	-	mA			
Supply Current in NORMAL mode	I <sub>DD</sub>		V <sub>DD</sub> = 4 V fc = 4.19 MHz V <sub>IN</sub> = 3.8 V / 0.2 V	fcgck	fc	-	2.25	3.6	mA	
Supply Current in IDLE mode					fc/2	-	1.35	2.5		
					fc/4	-	0.9	1.9		
					fc/8	-	0.7	1.65		
				Supply Current in NORMAL mode	fcgck	fc	-	1.2		1.9
fc/2						-	0.9	1.7		
fc/4						-	0.7	1.5		
Supply Current in IDLE mode				fcgck	fc/8	-	0.6	1.4		
					fcgck	fc	-	1.5		2.5
						fc/2	-	0.85		1.6
fc/4				-		0.6	1.2			
fc/8				-		0.4	1.0			
Supply Current in IDLE mode				fcgck	fc	-	0.8	1.4		
					fcgck	fc/2	-	0.55		1.1
						fc/4	-	0.45		0.9
Supply Current in IDLE mode				fcgck		fc/8	-	0.35		0.85
	fcgck	fc	-		0.9	1.3				
		fc/2	-		0.5	0.8				
fc/4		-	0.3	0.45						
fc/8		-	0.2	0.35						
Supply Current in IDLE mode	fcgck	fc	-	0.35	0.5					
		fcgck	fc/2	-	0.23	0.35				
			fc/4	-	0.17	0.26				
Supply Current in IDLE mode	fcgck		fc/8	-	0.14	0.24				
		V <sub>DD</sub> = 4.0 V			-	0.5	10	μA		
		V <sub>IN</sub> = 3.8 V / 0.2 V								

Note 1: Typical values show those at Topr = 25°C, VDD = 4 V.

Note 2: Input Current I<sub>IN1</sub>, I<sub>IN3</sub>: The current through resistor is not included, when the input resistor (pull-up or pull-down) is contained.

Note3: I<sub>DD</sub>; Except for I<sub>REF</sub>

A/D Conversion Characteristics ( I )

(V<sub>DD</sub> = 1.8 to 4.0 V, Topr = - 30 to 70°C, V<sub>SS</sub> = 0V)

Parameter	Symbol	Conditions	Min	Typ.	Max	Unit
Analog Reference Voltage	V <sub>AREF</sub>		1.8	-	V <sub>DD</sub>	V
	V <sub>ASS</sub>		V <sub>SS</sub>			
Analog Input Voltage Range	V <sub>AIN</sub>		V <sub>ASS</sub>	-	V <sub>AREF</sub>	V
Nonlinearity Error		1.8 V ≤ V <sub>AREF</sub> < 2.7 V V <sub>AREF</sub> ≤ V <sub>DD</sub> ≤ 4.0 V <sub>ASS</sub> (V <sub>SS</sub> ) = 0.000V ACK = 1 (Note2)	-	-	± 2	LSB
Zero Point Error			-	-	± 2	
Full Scale Error			-	-	± 2	
Total Error			-	-	± 4	

Note1: Quantizing error is not contained in those errors.

Note2: ACK ; bit5 of ADCCR (#000E<sub>H</sub>). conversion time = 184 tcy (175.6 μs / at f<sub>cgck</sub> = 4.19 MHz)

A/D Conversion Characteristics ( II )

(V<sub>SS</sub> = 0V, V<sub>DD</sub> = 2.7 to 4.0 V, Topr = - 30 to 70°C)

Parameter	Symbol	Conditions	Min	Typ.	Max	Unit
Analog Reference Voltage	V <sub>AREF</sub>		2.7	-	V <sub>DD</sub>	V
	V <sub>ASS</sub>		V <sub>SS</sub>			
Analog Input Voltage Range	V <sub>AIN</sub>		V <sub>ASS</sub>	-	V <sub>AREF</sub>	V
Analog Reference Current	I <sub>REF</sub>	V <sub>AREF</sub> = 4.0V, V <sub>ASS</sub> (V <sub>SS</sub> ) = 0.0V	-	0.5	1.0	mA
Nonlinearity Error		V <sub>DD</sub> = 4.0 V V <sub>AREF</sub> = 4.000V V <sub>ASS</sub> (V <sub>SS</sub> ) = 0.000V or V <sub>DD</sub> = 2.7 V V <sub>AREF</sub> = 2.700V V <sub>ASS</sub> (V <sub>SS</sub> ) = 0.000V	-	-	± 1	LSB
Zero Point Error			-	-	± 1	
Full Scale Error			-	-	± 1	
Total Error			-	-	± 2	

Note: Quantizing error is not contained in those errors.

A.C. Characteristics

(V<sub>SS</sub> = 0 V, V<sub>DD</sub> = 1.8 to 4.0 V, Topr = -30 to 70°C)

Parameter	Symbol	Conditions	Min	Typ.	Max	Unit
Machine Cycle Time	t <sub>cy</sub>	In NORMAL mode	0.95	-	4	μs
		In IDLE mode				
High Level Clock Pulse Width	t <sub>WCH</sub>	For external clock operation f <sub>c</sub> = 4.2 MHz	110	-	-	ns
Low Level Clock Pulse Width	t <sub>WCL</sub>					
A/D Conversion Time	t <sub>ADC</sub>	ACK = 0	-	46	-	t <sub>cy</sub>
		ACK = 1	-	184	-	
A/D Sampling Time	t <sub>AIN</sub>		-	4		

Note: A/D conversion timing:  
Internal circuit for AIN 0 to 5

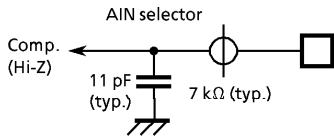

※ To maintain a precision of A/D conversion, internal condenser must be charged until t<sub>AIN</sub> is over.

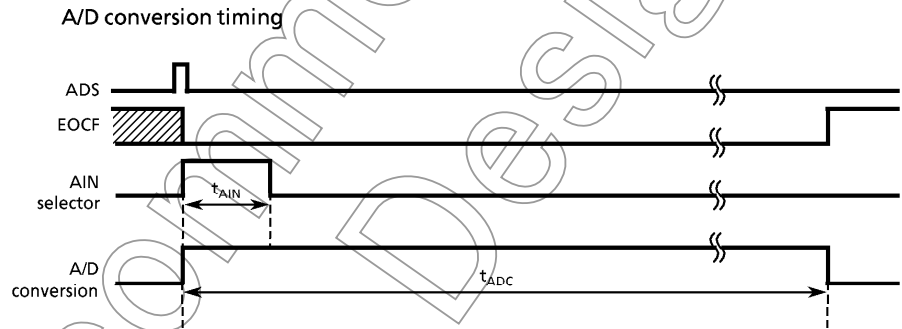

Not Recommended for New

Recommended Oscillating Conditions

(V<sub>SS</sub> = 0 V, Topr = - 30 to 70°C)

Parameter	Oscillator	Oscillation Frequency	Recommended Oscillator		Recommended Conditions	
					C <sub>1</sub>	C <sub>2</sub>
High-frequency Oscillation	Ceramic Resonator	4.19 MHz (VDD = 2.7 to 5.5 V)	MURATA	CSA4.19MG	30 pF	30 pF
			MURATA	CST4.19MGW	—	—
		4 MHz (VDD = 2.7 to 5.5 V)	MURATA	CSA4.00MG CSA4.00MGC	30 pF	30 pF
			MURATA	CST4.00MGW CSTC4.00MG	—	—
			MURATA	CSTCS4.00MG	—	—

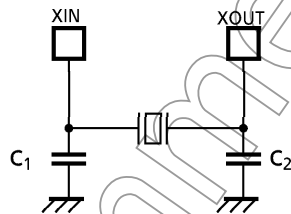

(1) High-frequency Oscillation

*Note: When used in high electric field such as a picture tube, the package is recommended to be electrically shielded to maintain a regular operation.*

Not Recommended for New Design



D.C. Characteristics, A.C. Characteristics

(V<sub>SS</sub> = 0 V)

(1) Read Operation (T<sub>opr</sub> = 0 to 70°C)

Parameter	Symbol	Conditions	Min	Typ.	Max	Unit
Input High Voltage	V <sub>IH4</sub>		V <sub>CC</sub> × 0.67	–	V <sub>CC</sub>	V
Input Low Voltage	V <sub>IL4</sub>		0	–	V <sub>CC</sub> × 0.3	V
Supply Voltage	V <sub>CC</sub>		4.75	5.00	5.25	V
Program Supply Voltage	V <sub>PP</sub>		V <sub>CC</sub> – 0.6	V <sub>CC</sub>	V <sub>CC</sub> + 0.6	
Address Set-up Time	t <sub>ASU</sub>		400	–	–	ns
Address Access Time	t <sub>ACC</sub>	V <sub>CC</sub> = 5.0 ± 0.25 V	–	5tcyc	–	ns

Note: tcyc = 400 ns

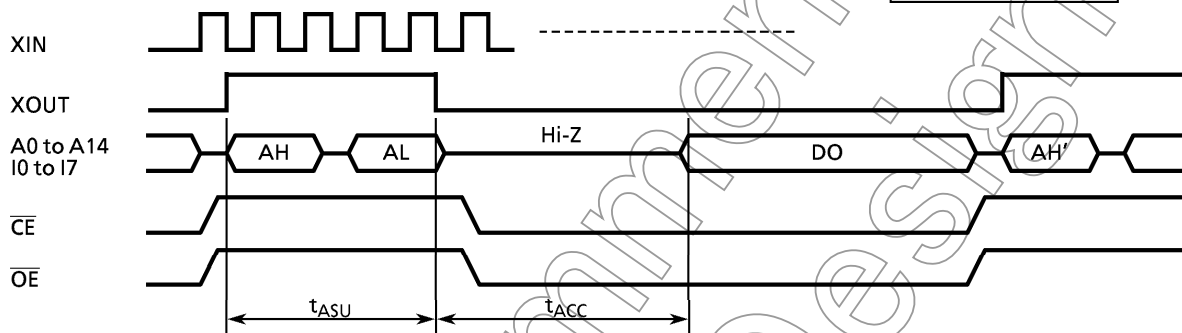

(2) Program Operation (High speed write mode - I) (T<sub>opr</sub> = 25 ± 5°C)

Parameter	Symbol	Conditions	Min	Typ.	Max	Unit
Input High Voltage	V <sub>IH4</sub>		V <sub>CC</sub> × 0.7	–	V <sub>CC</sub>	V
Input Low Voltage	V <sub>IL4</sub>		0	–	V <sub>CC</sub> × 0.12	V
Supply Voltage	V <sub>CC</sub>		5.75	6.0	6.25	V
Program Supply Voltage	V <sub>PP</sub>		12.0	12.5	13.0	V
Initial Program Pulse Width	t <sub>PW</sub>	V <sub>CC</sub> = 6.0 V ± 0.25 V, V <sub>PP</sub> = 12.5 V ± 0.25 V	0.95	1.0	1.05	ms

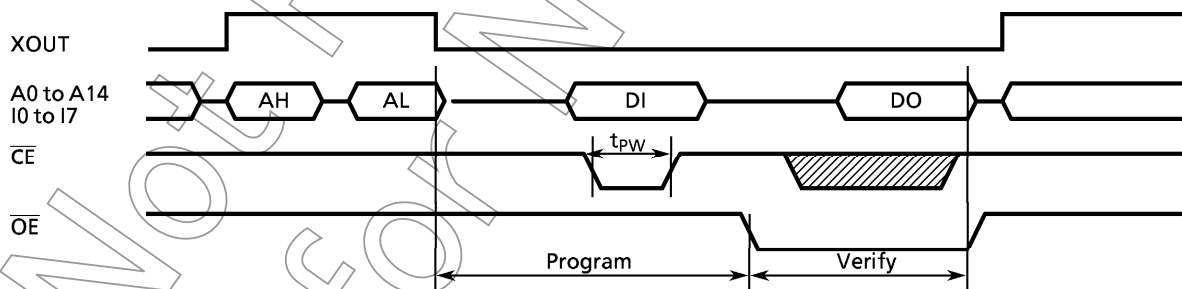

Note: DO ; Data output (I0 to I7) AL ; Address input (A0 to A7)  
DI ; Data input (I0 to I7) AH ; Address input (A8 to A14)

- Note 1: When V<sub>CC</sub> power supply is turned on or after, V<sub>PP</sub> must be increased.  
When V<sub>CC</sub> power supply is turned off or before, V<sub>PP</sub> must be decreased.
- Note2: The device must not be set to the EPROM programmer or picked up from it under applying the program voltage (12.5 V ± 0.5 V) to the V<sub>PP</sub> pin as the device is damaged.
- Note3: Be sure to execute the recommended programing mode with the recommended programing adaptor. If a mode or an adaptor except the above, the misoperation sometimes occurs.

(3) Program Operation (High speed write mode - II) ( $T_{opr} = 25 \pm 5^{\circ}\text{C}$ )

Parameter	Symbol	Conditions	Min	Typ.	Max	Unit
Input High Voltage	$V_{IH4}$		$V_{CC} \times 0.7$	-	$V_{CC}$	V
Input Low Voltage	$V_{IL4}$		0	-	$V_{CC} \times 0.12$	V
Supply Voltage	$V_{CC}$		6.00	6.25	6.50	V
Program Supply Voltage	$V_{PP}$		12.50	12.75	13.0	V
Initial Program Pulse Width	$t_{PW}$	$V_{CC} = 6.25 \text{ V} \pm 0.25 \text{ V}$ , $V_{PP} = 12.75 \text{ V} \pm 0.25 \text{ V}$	0.095	0.1	0.105	ms

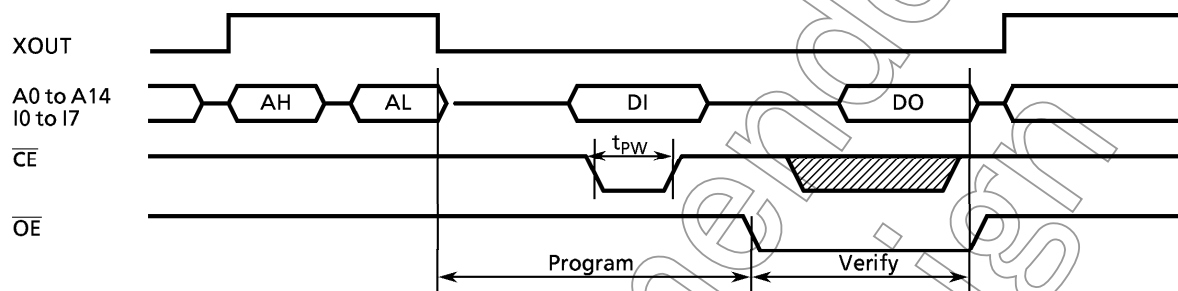

Note: DO ; Data output (I0 to I7)    AL ; Address input (A0 to A7)  
 DI ; Data input (I0 to I7)        AH ; Address input (A8 to A14)

- Note1: When  $V_{CC}$  power supply is turned on or after,  $V_{PP}$  must be increased.  
 When  $V_{CC}$  power supply is turned off or before,  $V_{PP}$  must be decreased.
- Note2: The device must not be set to the EPROM programmer or picked up from it under applying the program voltage ( $12.5 \text{ V} \pm 0.5 \text{ V}$ ) to the  $V_{PP}$  pin as the device is damaged.
- Note3: Be sure to execute the recommended programming mode with the recommended programming adaptor. If a mode or an adaptor except the above, the misoperation sometimes occurs.

Recommended EPROM Programmer

- DATA I/O            UNISTTE (SITE40)
- ADVANTEST        R4945A
- AVAL DATA        PECKER11    MARK-II (version 5.5)