



FRACTIONAL-N PLL WITH INTEGRATED VCO, 9.6 - 10.8 GHz

Features

- RF Bandwidth: 9.6 GHz to 10.8 GHz
- Fractional or Integer Modes
- Ultra Low Phase Noise
10.2 GHz; 50 MHz Ref.
-106 / -102 dBc/Hz @ 10 kHz (Int / frac)
-140 dBc/Hz @ 1 MHz (Open Loop)
- Figure of Merit (FOM)
-230 / -227 dBc/Hz (int / Frac)
- 24-bit Step Size, Resolution 3 Hz typ
- 350 MHz, 14-bit reference path input
- Frequency And Phase Modulation
- Integrated Frequency Sweeper
- Triggered Frequency Hopping
- External Triggering
- 40 Lead 6 x 6 mm SMT Package: 36 mm²

Typical Applications

- VSAT Radio
- Microwave Point-To-Point Radios
- Test Equipment & Industrial Control
- Military End-Use
- Phased Array Applications
- FMCW Radar Systems

Functional Diagram

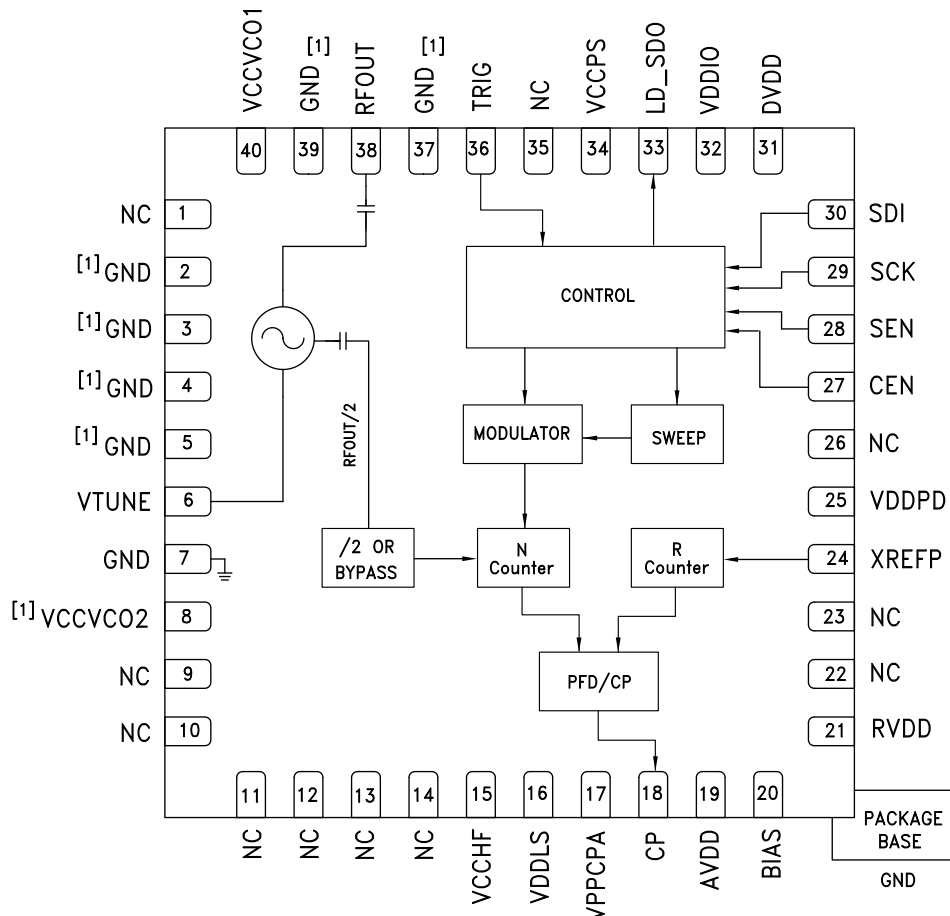

[1] Please refer to the pin description table for details

**FRACTIONAL-N PLL WITH
 INTEGRATED VCO, 9.6 - 10.8 GHz**
General Description

The HMC778LP6CE is a fully functioned Fractional-N Phase-Locked-Loop (PLL) Frequency Synthesizer with an integrated Voltage Controlled Oscillator (VCO). The input reference frequency range is DC to 350 MHz while the advanced delta-sigma modulator design in the fractional synthesizer allows both ultra-fine step sizes and very low spurious products. The highly integrated structure provides excellent phase noise performance over temperature, shock and process. In addition, the HMC778LP6CE offers frequency sweep and modulation features, external triggering, double-buffering, exact frequency control, phase modulation and more. The HMC778LP6CE is packaged in a leadless QFN 6 x 6 mm surface mount package.

For theory of operation and register map refer to the "PLLs w/ Integrated VCO - Microwave VCOs" Operating Guide. To view the [Operating Guide](#), please visit www.hittite.com and choose HMC778LP6CE from the "Search by Part Number" pull down menu.

**Electrical Specifications, $T_A = +25^\circ\text{C}$; VCCVCO, VDDL5, VPPCPA = +5V;
 RVDD, AVDD, VCCPS, VCCH \bar{F} , VDDPD, DVDD, VDDIO = + 3.3V**

Parameter	Condition	Min.	Typ.	Max.	Units
RF Output Characteristics					
VCO Output Frequency Range		9.6	10.2	10.8	GHz
VCO Output Power ^[1]			9		dBm
VCO Tuning Voltage		2		13	V
VCO Tuning Sensitivity	$V_{TUNE} = 6V$		165		MHz/V
Frequency Pulling	into a 2:1 VSWR		5		MHz pp
Frequency Pushing	$V_{TUNE} = 5V$		30		MHz/V
Frequency Drift Rate			1.2		MHz/ °C
Sub Harmonic (1/2)			33		dBc
Harmonic (2 nd)			25		dBc
Harmonic (3 rd)			35		dBc
VCO SSB Phase Noise @ 100 kHz Offset (Open Loop)	$V_{TUNE} = +5V$ $F_{VCO} = 10\text{ GHz}$		-110		dBc/Hz
Synthesizer In-Band SSB Phase Noise @ 10 kHz Offset (Integer / Fractional)	$F_{ref} = 50\text{ MHz}$ $F_{VCO} = 10.2\text{ GHz}$ Loop BW = 100 kHz		-106/-102		dBc/Hz
Synthesizer Noise Floor, Figure Of Merit (Integer / Fractional)			-230 / -227		dBc/Hz
Synthesizer Fractional Spurs ^[2]			-65	-45	dBc
Synthesizer Frequency Settling Time (100 MHz Step)	10.2 GHz to 10.3 GHz Loop BW = 100 kHz, 10°		195		μs
RF/2 Divider Range					
> 4GHz Integer Mode	16 bit, even values only	32		131,070	
< 4GHz Integer Mode	16 bit, all values	16		65,535	
> 4GHz Fractional Mode	16 bit	40		131,065	
< 4GHz Fractional Mode	16 bit	20		65,531	

[1] See power output vs.tuning voltage graph for power slope.

[2] Actual spur level is dependent on loop parameters and will increase at division ratios closest to integer boundaries.

Electrical Specifications (Continued)

Parameter	Condition	Min.	Typ.	Max.	Units
REF Input Characteristics					
Frequency Range (3.3V)		DC	50	350	MHz
Power From 50Ω Source	With off chip 100Ω termination		6		dBm
Return Loss		-16		-8	dBm
Ref Divider Range (14-Bit)		1		16,383	
Phase Detector Rate					
Integer Mode		DC	50	115	MHz
Fractional Mode A		DC	50	80	MHz
Fractional Mode B		DC	50	100	MHz
Charge Pump					
CP Output Current	20μA steps CP_gain = CP_current ÷ 2π (amps/rad)	0.02		2.5	mA
CP HIK	see "Charge Pump Gain" section of "Operation Guide"		3.5	6	mA
Logic Inputs					
Switching Threshold (Vsw)	VIH/VIL within 50mV of Vsw	38	47	54	%VDDIO
Logic Outputs					
VOH Output High Voltage			VDDIO		V
VOL Output Low Voltage			0		V
Output Impedance: Pull Up	VDDIO = 3.3V	115	150	180	Ω
Output Impedance: Pull Dn	VDDIO = 3.3V	130	135	210	Ω
DC Load				1.5	mA
Digital Output Driver Delay SCK to Digital Output Delay	1.7 ns with a 3 pF load		0.5ns + 0.2ns/pF 8.2ns + 0.2ns/pF		ns
Power Supply Voltages					
VCCVCO - VCO Supply		4.75	5.0	5.25	V
RVDD, AVDD, VCCPS, VCCHF, VDDPD - Analog Supply	all must be equal	2.7	3.3	3.5	V
DVDD, VDDIO - Digital Supply	both must be equal	2.7	3.3	3.5	V
VDDL, VPPCPA - Charge pump	both must be equal	4.7	5.0	5.2	V
Power Supply Currents					
5.0V - VCO Current Consumption		230	265	290	mA
3.3V - PLL Current Consumption	all modes	34	54	95	mA
5.0V - Charge Pump Current Consumption	all modes	3	7	16	mA
Power Down Current	except VCO			100	μA
Bias Reference Voltage (Pin 20)	Measured with 10 GΩ meter	1.88	1.92	1.96	V



FRACTIONAL-N PLL WITH INTEGRATED VCO, 9.6 - 10.8 GHz

SSB Phase Noise vs. Frequency, Integer Mode, Fref = 50 MHz, Loop BW = 100 kHz

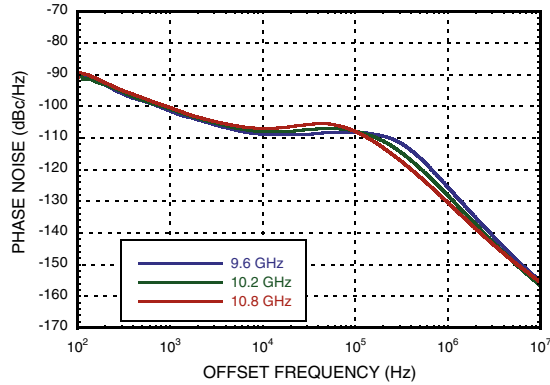

SSB Phase Noise vs. Temperature @ 10.20 GHz, Integer Mode, Fref = 50 MHz, Loop BW = 100 kHz

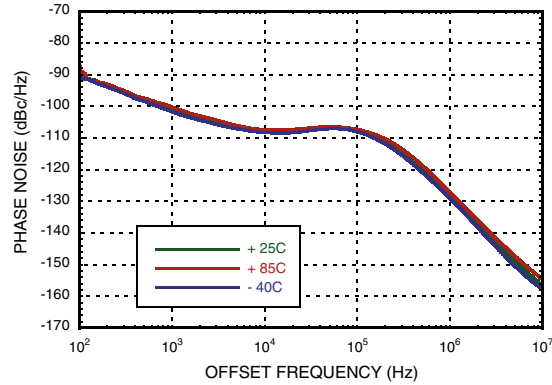

SSB Phase Noise Fractional Spurs @ 10.21 GHz, Fref = 10 MHz, Loop BW = 10 kHz

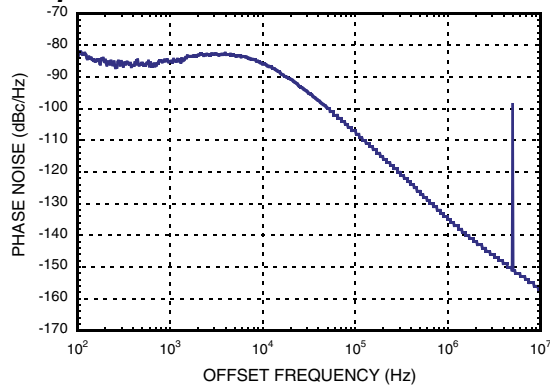

SSB Phase Noise vs. Reference Freq. & Loop BW @ 10.20 GHz, Integer Mode

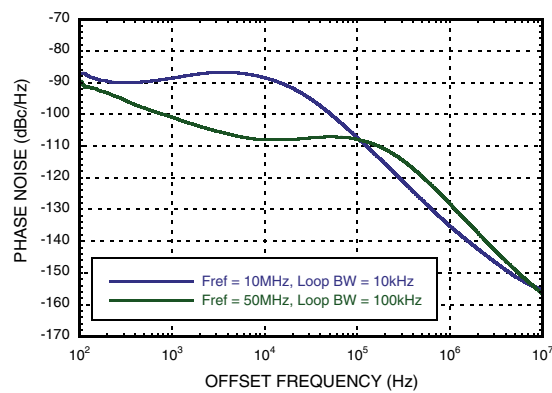

Reference Input Sensitivity, Square Wave, 50Ω

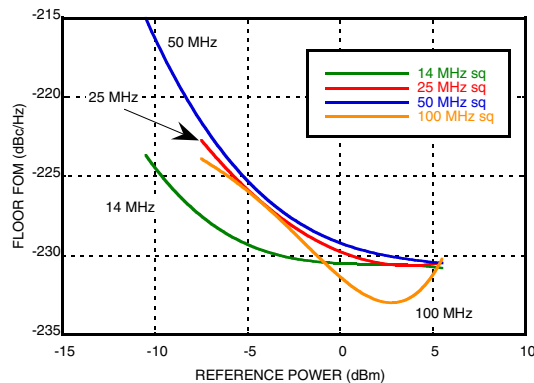

Reference Input Sensitivity, Sinusoid Wave, 50Ω

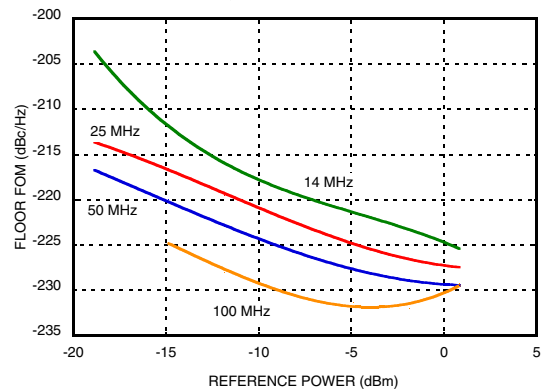



FRACTIONAL-N PLL WITH INTEGRATED VCO, 9.6 - 10.8 GHz

PLLS WITH INTEGRATED VCO - SMT

Frequency vs. Tuning Voltage, Vcc = +5V

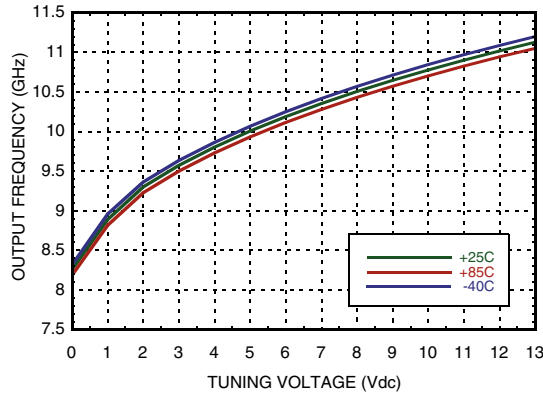

Frequency vs. Tuning Voltage, T = 25°C

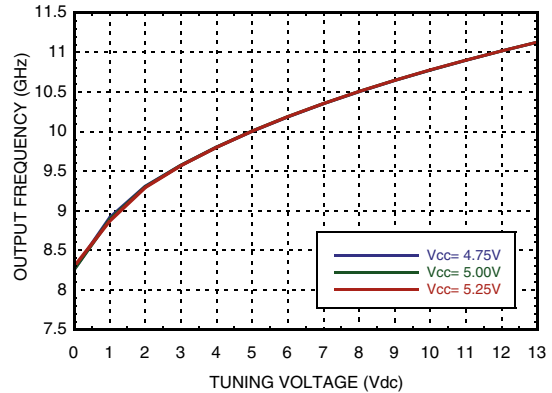

Sensitivity vs. Tuning Voltage, Vcc = +5V

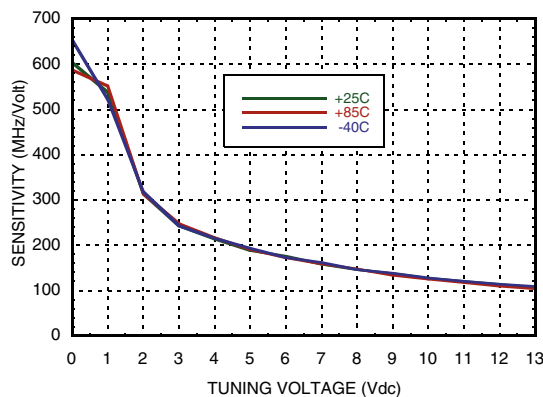

Output Power vs. Tuning Voltage, Vcc = +5V

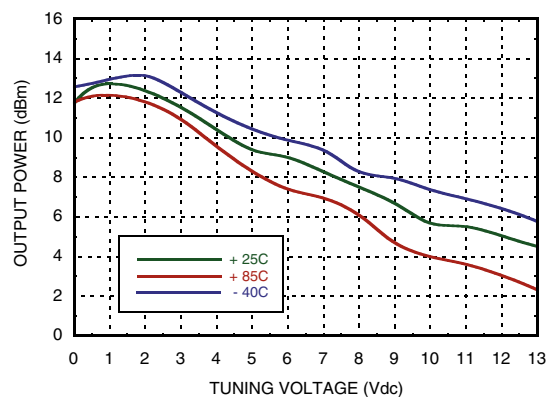

Open Loop VCO SSB Phase Noise vs. Tuning Voltage

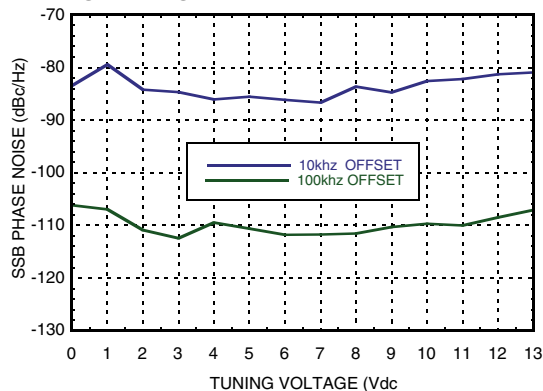

Open Loop VCO SSB Phase Noise, Vtune = +5V

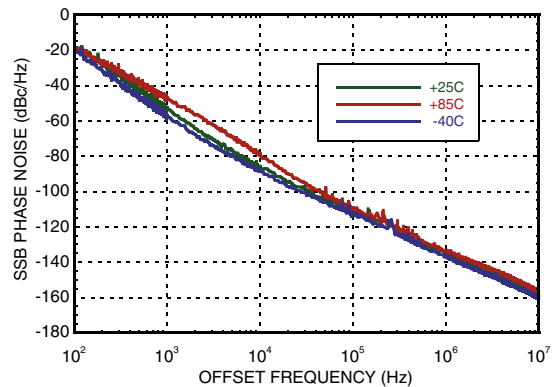

**FRACTIONAL-N PLL WITH
INTEGRATED VCO, 9.6 - 10.8 GHz**
Absolute Maximum Ratings

VCCVCO1, VCCVCO2	+5.5V
Vtune	0 to +15V
RVDD, AVDD, VCCPS, VCCHF, VDDPD	-0.3V to +3.6V
DVDD, VDDIO	-0.3V to +3.6V
VDDL5, VPPCPA	-0.3V to +5.5V
Digital Load	1 K Ω min.
Digital Input 1.4V to 1.7V min. rise time	20 ns
Digital Input Voltage Range	-0.25V to VDDIO + 0.5V
Storage Temperature Range	-65° C to +125° C
ESD Sensitivity (HBM)	Class 1A

Reliability Information

Junction Temperature To Maintain 1 Million Hours MTTF	135 °C
Nominal Junction Temperature (T = +85°C)	123°C
Thermal Resistance (Junction to GND Paddle, 5V Supply)	24.7 °C/W
Operating Temperature	-40 to +85°C

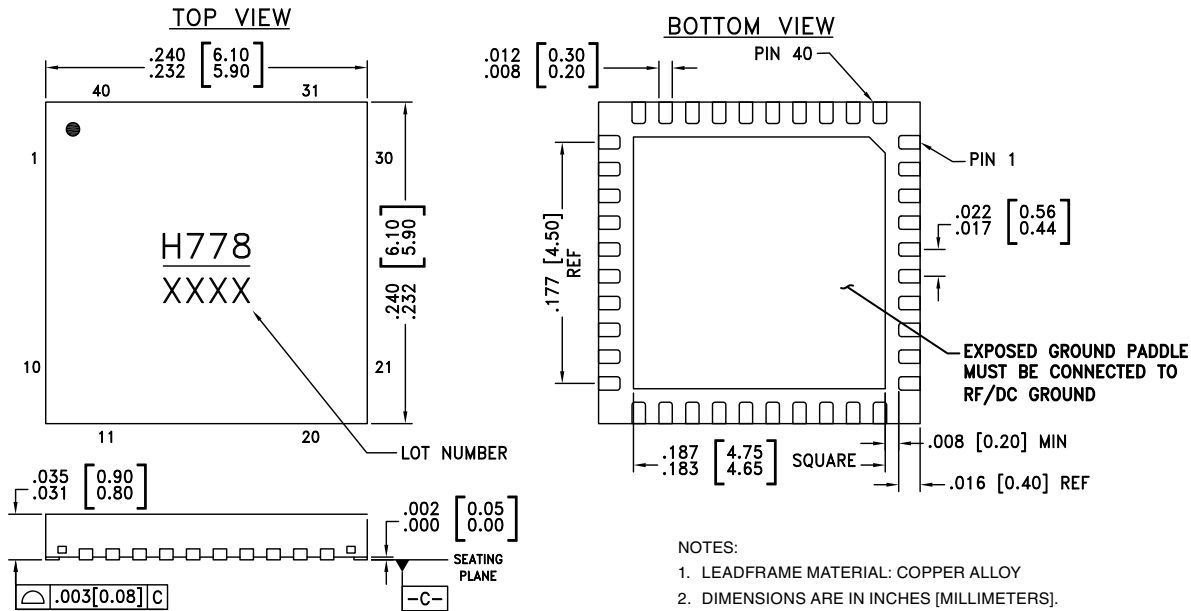
Outline Drawing

Package Information

Part Number	Package Body Material	Lead Finish	MSL Rating	Package Marking ^[1]
HMC778LP6CE	RoHS-compliant Low Stress Injection Molded Plastic	100% matte Sn	MSL3	H778 XXXX

[1] 4-Digit lot number XXXX

Pin Descriptions

Pin Number	Function	Description
1, 9 - 14, 22, 23, 26, 35	N/C	No connection. These pins may be connected to RF/DC ground. Performance will not be affected.
2 - 5, 37, 39	GND [1]	Pins must be connected to RF/DC ground
7	GND	This pin and package bottom must be connected to RF/DC ground
6	VTUNE	Control voltage input. Modulation port bandwidth dependent on drive source impedance.
8	VCCVCO2	+ 5V power supply for VCO.
15	VCCHF	Analog power supply for RF buffer. Nominal + 3.3V, 6 mA max.
16	VDDL5	Power supply for PFD to CP level shifters. Nominal + 5V, 5 mA max., Fpd dependent.
17	VPPCPA	Power Supply for the charge pump. Nominal + 5V, 10 mA Max.
18	CP	Charge pump output
19	AVDD	Power Supply for analog bias generation. Nominal + 3.3V, 2 mA Max.
20	BIAS [2]	External bypass decoupling for precision bias circuits, 1.920V \pm 2 mV is generated internally
21	RVDD	Power Supply for Reference Path. Nominal + 3.3V, 15 mA Max., reference dependent
24	XREFP	Reference input. DC bias is generated internally. Normally AC coupled externally.
25	VDDPD	Power supply for phase detector. Nominal + 3.3V. Decoupling for this supply is critical. 5 mA max., Fpd dependent.
27	CEN	CMOS input, hardware chip enable.
28	SEN	CMOS input, serial port latch enable.
29	SCK	CMOS input, serial port clock.
30	SDI	CMOS input, serial port data.
31	DVDD	Power supply for digital. Nominal + 3.3V, 25 mA max., Fpd dependent.
32	VDDIO	Power supply for digital I/O. Nominal + 3.3V, 8 mA max. (only when driving LD_SDO)
33	LD_SDO	CMOS output. General purpose output; lock detect, serial data out, others, selectable
34	VCCPS	Power supply for RF divider. Nominal + 3.3V, 35 mA max.
36	TRIG	CMOS input. External trigger.
38	RFOUT	RF output (AC coupled).
40	VCCVCO1	Power Supply for VCO. Nominal +5V, High Current, VCO dependent

[1] Pins are not connected internally, however, pins must be connected to GND to maintain product family pin for pin compatibility.

[2] BIAS ref voltage (pin 20) cannot drive an external load, and must be measured with a 10 GOhm meter such as Agilent 34410A; a typical 10 Mohm DVM will read erroneously.



**FRACTIONAL-N PLL WITH
INTEGRATED VCO, 9.6 - 10.8 GHz**

Evaluation PCB

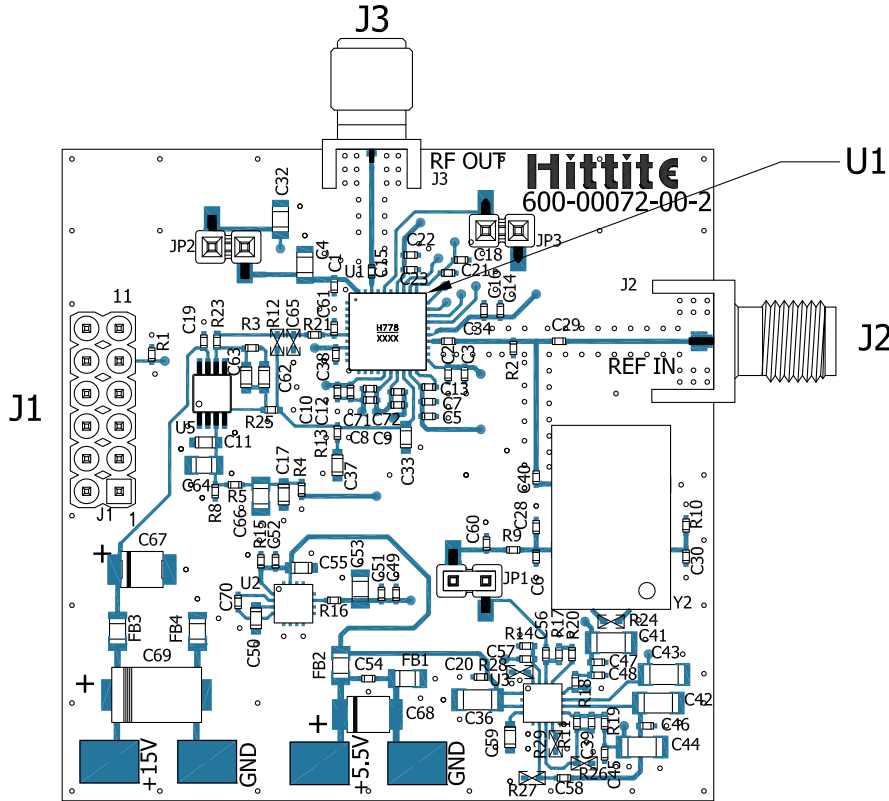

The circuit board used in the application should use RF circuit design techniques. Signal lines should have 50 Ohm impedance while the package ground leads and exposed paddle should be connected directly to the ground plane similar to that shown. A sufficient number of via holes should be used to connect the top and bottom ground planes. The evaluation circuit board shown is available from Hittite upon request.

Evaluation PCB Schematic

To view this Evaluation PCB Schematic please visit www.hittite.com and choose HMC778LP6CE from the “Search by Part Number” pull down menu to view the product splash page.

Evaluation Order Information

Item	Contents	Part Number
Evaluation PCB Only	HMC778LP6CE Evaluation PCB	130371-HMC778LP6CE
Evaluation Kit	HMC778LP6CE Evaluation PCB USB Interface Board 6' USB A Male to USB B Female Cable CD ROM (Contains User Manual, Evaluation Software, Hittite PLL Design Software)	EKIT01-HMC778LP6CE