

BBS-1080S

**19" 1U Height Half-size Bare Bone System
with Pentium 4 Embedded Engine Board
& 180W P4 ATX P/S**

- **19" 1U Height Half-size Rackmount Chassis •**
 - **HS-4701 Embedded Engine Board •**
 - **Celeron 2GHz CPU • 128MB DDR •**
 - **BS-667 Capture Card • 3.5" 80G HDD •**
 - **180W P4 ATX Power Supply •**

Copyright Disclaimers

The accuracy of contents in this manual has passed thorough checking and review before publishing. BOSER Technology Co., Ltd., the manufacturer and publisher, is not liable for any infringements of patents or other rights resulting from its use. The manufacturer will not be responsible for any direct, indirect, special, incidental or consequential damages arising from the use of this product or documentation, even if advised of the possibility of such damage(s).

This manual is copyrighted and BOSER Technology Co., Ltd. reserves all documentation rights. Unauthorized reproduction, transmission, translation, and storage of any form and means (i.e., electronic, mechanical, photocopying, recording) of this document, in whole or partly, is prohibited, unless granted permission by BOSER Technology Co., Ltd.

BOSER Technology Co., Ltd. reserves the right to change or improve the contents of this document without due notice. BOSER Technology Co., Ltd. assumes no responsibility for any errors or omissions that may appear in this manual, nor does it make any commitment to update the information contained herein.

Trademarks

BOSER is a registered trademark of BOSER Technology Co., Ltd.

ISB is a registered trademark of BOSER Technology Co., Ltd.

Intel is a registered trademark of Intel Corporation.

Award is a registered trademark of Award Software, Inc.

AMI is a registered trademark of American Megatrends, Inc.

All other trademarks, products and or product names mentioned herein are mentioned for identification purposes only, and may be trademarks and/or registered trademarks of their respective companies or owners.



**© Copyright 2003 BOSER Technology Co., Ltd.
All Rights Reserved.
Edition 1.1, November 28, 2003**

Table of Contents

Chapter 1	General Description.....	1
1.1	Hardware Features	2
1.2	System Features.....	2
1.3	Relay Specifications	2
1.4	Hardware Specifications.....	3
1.5	Software Functions	3
1.6	Dimensions	5
1.7	I/O Outlets	5
Chapter 2	Unpacking.....	7
2.1	Opening the Delivery Package.....	7
2.2	Inspection.....	7
Chapter 3	Hardware Installation.....	9
3.1	Open the Cover.....	9
3.2	Close the Cover	10
3.3	HDD and PCI Card Setup	10
3.4	A-1048 Expansion Card Setup	13
Chapter 4	SBC Hardware Installation.....	17
4.1	Before Installation	17
4.2	Board Layout	18
4.3	Jumper List	19
4.4	Connector List	19
4.5	Configuring the CPU	20
4.6	System Memory	20
4.7	VGA Controller.....	20
4.8	PCI E-IDE Drive Connector	22
4.9	Floppy Disk Drive Connector	24
4.10	Serial Port Connectors	25
4.11	Parallel Connector.....	26
4.12	Ethernet Connector	27
4.13	USB Connector.....	27
4.14	CMOS Data Clear	28
4.15	Power and Fan Connectors.....	28
4.16	Keyboard/Mouse Connectors	29
4.17	System Front Panel Connectors.....	29
4.18	External Speaker	30

4.19 Audio Connectors	30
4.20 Digital Input/Output.....	31
4.21 TV Out Function.....	32
4.22 Mini AGP Connector	32
4.23 PCI Expansion Slot	32
Chapter 5 Award BIOS Setup.....	33
5.1 Starting Setup.....	33
5.2 Using Setup.....	34
5.2.1 Getting Help	34
5.3 Main Menu	35
5.4 Standard CMOS Setup	36
5.5 Advanced CMOS Setup	37
5.6 Advanced Chipset Setup	38
5.7 Power Management Setup.....	39
5.8 PCI / Plug and Play Setup.....	40
5.9 Peripheral Setup.....	41
5.10 PC Health Status.....	42
5.11 Frequency/Voltage Control	42
Chapter 6 Software Utilities.....	43
6.1 IDE Driver Installation	43
6.1.1 Installing Intel Chipset Software Utility	43
6.1.2 Installing Intel Application Accelerator	46
6.2 VGA Driver Installation	49
6.2.1 Win 98.....	49
6.2.2 Win NT	52
6.2.3 Win 2000	55
6.3 LAN Driver Installation.....	58
6.3.1 Win 95/98	58
6.3.2 Win NT	61
6.4 Audio Driver Installation.....	67
Appendix A Power Supply.....	71
A.1 Safety Approvals	71
A.1.1 EMI Regulatory	71
A.1.2 Safety	71
A.2 Physical Requirements.....	72
A.2.1 Mechanical Specifications	72
A.2.2 Connector Specifications.....	72
A.2.3 Connector PIN Designations	72
A.3 Electrical Requirements	73
A.4 Environmental Requirements	76
A.5 Safety	77
A.6 Electromagnetic Compatibility	77

A.7 Labeling	77
A.8 Reliability	77
A.9 Safety Requirements	78
A.10 Dimensions	78

Appendix B Capture Card.....79

B.1 Features.....	79
B.2 Frame Rate	79
B.3 Image Acquisition.....	80
B.4 I/O Lines	80
B.5 Watchdog Timer	80
B.6 Applications	80
B.7 Software Supporting WDM Driver.....	80

Safety Instructions

Before getting started, read the following important cautions.

- 1.** The BBS-1080S does not come equipped with an operating system. An operating system must be loaded first before installing any software into the computer.
- 2.** Be sure to ground yourself to prevent static charge when installing the internal components. Use a grounding wrist strap and place all electronic components in any static-shielded devices. Most electronic components are sensitive to static electrical charge.
- 3.** Disconnect the power core from the BBS-1080S before making any installation. Be sure both the system and the external devices are turned OFF. Sudden surge of power could ruin sensitive components. Make sure the BBS-1080S is properly grounded.
- 4.** The brightness of the flat panel display decreases with usage. However, hours of use vary depending on the application environment.
- 5.** The flat panel display is not susceptible to shock or vibration. When assembling the BBS-1080S, make sure it is securely installed.
- 6.** Do not open the system's back cover. If opening the cover for maintenance is a must, only a trained technician is allowed to do so. Integrated circuits on computer boards are sensitive to static electricity. To avoid damaging chips from electrostatic discharge, observe the following precautions:

Before handling a board or integrated circuit, touch an unpainted portion of the system unit chassis for a few seconds. This will help to discharge any static electricity on your body.

When handling boards and components, wear a wrist-grounding strap, available from most electronic component stores.

Safety Approvals

- ◆ **CE Marking**
- ◆ **FCC**

FCC Compliance

This equipment has been tested and complies with the limits for a Class B digital device, pursuant to Part 15 of the FCC Rules. These limits are designed to provide reasonable protection against harmful interference in a residential installation. If not installed and used in accordance with proper instructions, this equipment might generate or radiate radio frequency energy and cause harmful interference to radio communications. However, there is no guarantee that interference will not occur in a particular installation. If this equipment does cause harmful interference to radio or television reception, which can be determined by turning the equipment off and on, the user is encouraged to try to correct the interference by one or more of the following measures:

1. Reorient or relocate the receiving antenna.
2. Increase the separation between the equipment and receiver.
3. Connect the equipment into an outlet on a circuit different from that to which the receiver is connected.
4. Consult the dealer or an experienced radio/TV technician for help.
5. Shielded interface cables must be used in order to comply with emission limits.

Chapter 1

General Description



Enclosed in a 19" 1U height half-size chassis structure, the physical appearance of the BBS-1080S may seem to be identical to a high-powered DC power supply, but do not let its physical attributes mislead you. This bare bone houses a semi-functional system based on the HS-4701 SBC that supports Pentium 4 CPU.

Powered by an 180W ATX power supply, the BBS-1080S's front panel incorporates various six LEDs, and back panel provides connectors for VGA, LAN, 4COM, audio, capture in, USB, I/O module, keyboard and mouse for user can friendly connections. The chassis can also accommodate one 3.5" 80G HDD and four channels real-time capture card.

1.1 Hardware Features

The BBS-1080S comes with the following hardware features:

- Built-in Celeron 2GHz CPU, 128MB DDR, 180W P4 ATX power supply
- Intel® 82845GE/82801DB system chipset
- Intel 82845GE CRT display controller
- Intel 82562 10/100 Based LAN
- AC97 3D audio controller
- Four COM, two USB2.0 connectors
- Four channels real-time video capture in
- One 3.5" 80G HDD
- Two 4cm ball bearing cooling fans (optional)
- Supports I/O module function

1.2 System Features

The BBS-1080S comes with the following system features:

- Operation System: Embedded Linux
- Four Video input connectors (BNC)
- Total Frame Rate: 120fps(NTSC) or 100fps(PAL)
- Video Compression: MPEG4 with high video quality and low data rate
- Video Data Rate: 40k~500kbps channel at full frame rate
- Audio Compression: GSM
- Audio Data Rate: 12kbp at 8k sample rate
- Video and audio synchronizes recording & playback
- Embedded HTTP server for web access

1.3 Relay Specifications

■ Contact Capacity:

- NO:** 10A at 125VAC
5A at 250VAC
5A at 30VDC
- NC:** 5A at 125VAC
3A at 250VAC

1.4 Hardware Specifications

- **System Board:** HS-4701 industrial Embedded engine board
- **CPU:** P4 Celeron 2GHz CPU (400FSB)
- **Memory:** Two DDR sockets supporting up to 2GB
- **Chipset:** Intel® 82845GE/82801DB
- **VGA:** Intel® 82845GE with 1MB or 8MB memory supporting CRT display up to 1280 x 1024 at 32-bit colors
- **Capture:** BS-667 four channels real-time capture card
- **LAN:** Intel® 82562 10/100 Based LAN
- **Audio:** AC97 3D audio controller
- **I/O Module:** 8-bit digital input and 4-bit relay output
- **FDD/HDD/CD-ROM:** One 3.5" 80G HDD
- **Serial Port:** One RS-232/422/485 and three RS-232, OR four RS-232
- **USB:** Two USB2.0 connectors
- **Keyboard:** PS/2 6-pin Mini DIN
- **Mouse:** PS/2 6-pin Mini DIN
- **Watchdog Timer:** Software program time-out intervals from 1~256 sec.
- **Thermal Solution:** Two 4cm ball bearing cooling fans (optional)
- **Power Supply:** 180W P4 ATX power supply
- **Dimensions/Weight:** 44.0 x 4.4 x 27.0 cm/7kgs.

1.5 Software Functions

- **Recording**
 - ◆ **Time Scheduled:** Multiple schedules per camera
 - ◆ **Triggered:** Motion alarm can trigger multiple camera recording and output reaction, such as turn on the siren. OR any sensor alarm can trigger multiple camera recordings and output reaction
 - ◆ **On-demand:** From local GUI or web page
 - ◆ **Pre-alarm & post alarm recording**
- **Replay**
 - ◆ **Replay on local GUI, web page, or while recording**
- **PTZ Camera Control**
 - ◆ **Supports the PTZ control on local GUI or web pages**
- **Internet Connection**
 - ◆ **Ethernet for ADSL or cable modem (TCP/IP)**
 - ◆ **RS-232C with external modem (PPP) can dial-out or dial-in**

- **Digital Input**
 - ◆ Any input can be assigned with multiple alarm reactions which can be a camera recording or a relay output
- **Replay Output**
 - ◆ **Reaction Control:** Triggered by sensor alarm or motion detection alarm
 - ◆ **Time Scheduled Control:** Any replay output can be assigned with multiple schedules to control the external equipment
- **Alarm Forwarding**
 - ◆ Send the e-mail with video clip or few images when there is an alarm
 - ◆ Send the SMS and MMS when there is alarm
- **Web Page Operation**
 - ◆ Access live video (one or four video at a time)
 - ◆ Browse the alarm list or the recording list and play the selected recording
 - ◆ Download any of recordings
 - ◆ Check the I/O point status
 - ◆ Execute the output and PTZ control
 - ◆ Configure and reboot the DVR
- **Supported Web Browser**
 - ◆ IE 5.5 or above for PC
 - ◆ IE for PDA (Pocket PC system)
- **Requirement of PC Client**
 - ◆ Windows 98/NT/2000 or XP with IE browser 5.5 or above
 - ◆ DirectX, latest version
 - ◆ Multimedia Player 8.0 or above

1.6 Dimensions

The BBS-1080S chassis size is shown below:

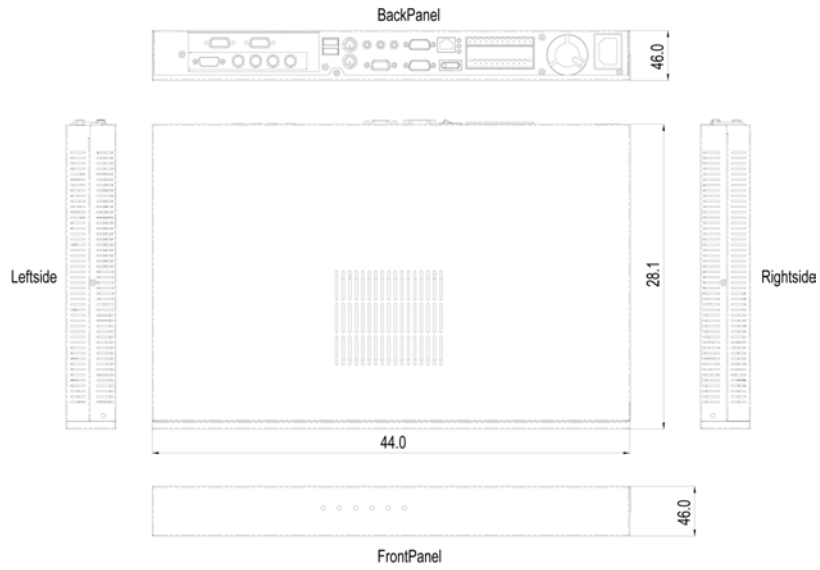

1.7 I/O Outlets

The following figure shows the I/O arrangement of the BBS-1080S.

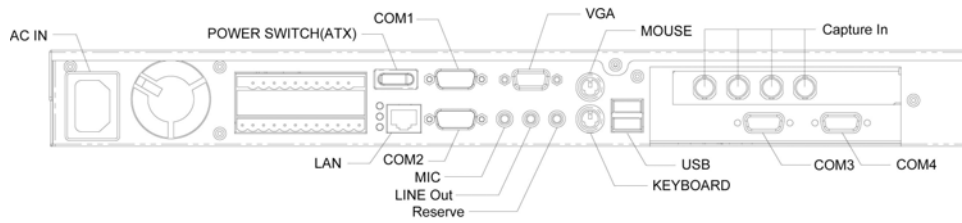

This page intentionally left blank.

Chapter 2

Unpacking

2.1 Opening the Delivery Package

The BBS-1080S is packed in an anti-static bag. The board has components that are easily damaged by static electricity. Do not remove the anti-static wrapping until proper precautions have been taken. Safety Instructions in front of this manual describe anti-static precautions and procedures.

2.2 Inspection

After unpacking the board, place it on a raised surface and carefully inspect the board for any damage that might have occurred during shipment. Ground the board and exercise extreme care to prevent damage to the board from static electricity.

Integrated circuits will sometimes come out of their sockets during shipment. Examine all integrated circuits, particularly the BIOS, processor, memory modules, ROM-Disk, and keyboard controller chip to ensure that they are firmly seated. The BBS-1080S delivery package contains the following items:

- ◆ BBS-1080S Bare Bone System x 1
- ◆ AC Power Core x 1
- ◆ Utility Disc
- ◆ User's Manual

The BBS-1080S system along with its accessories is packed in several bags and boxes, all packed in one carton. Before you start, carefully read the safety instructions in front of this User's Manual.

It is recommended that you keep all the parts of the delivery package intact and store them in a safe/dry place for any unforeseen event requiring the return shipment of the product. In case you discover any missing and/or damaged items from the list of items, please contact your dealer immediately.

This page intentionally left blank.

Chapter 3

Hardware Installation

This chapter tells how to install components into the Bare Bone system. External Interface please refers to SBC's manual.

3.1 Open the Cover

1. Please loose 3 screws, and open the cover

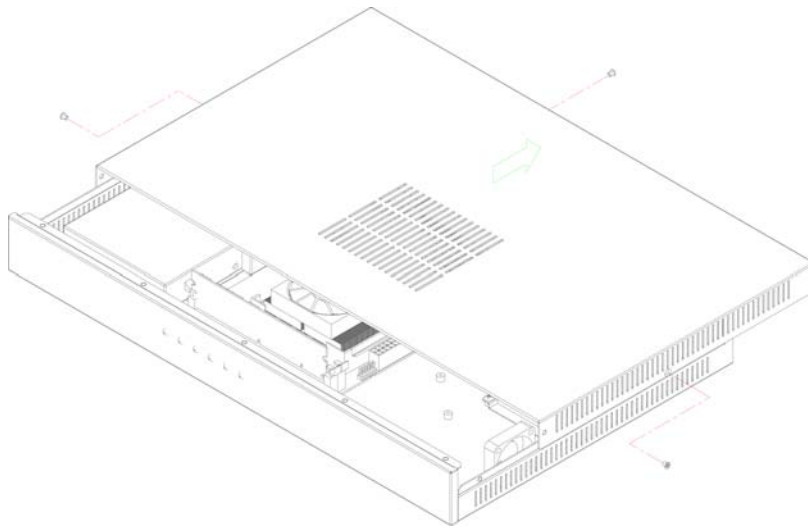

3.2 Close the Cover

1. Please slide in the cover, and tighten screws.

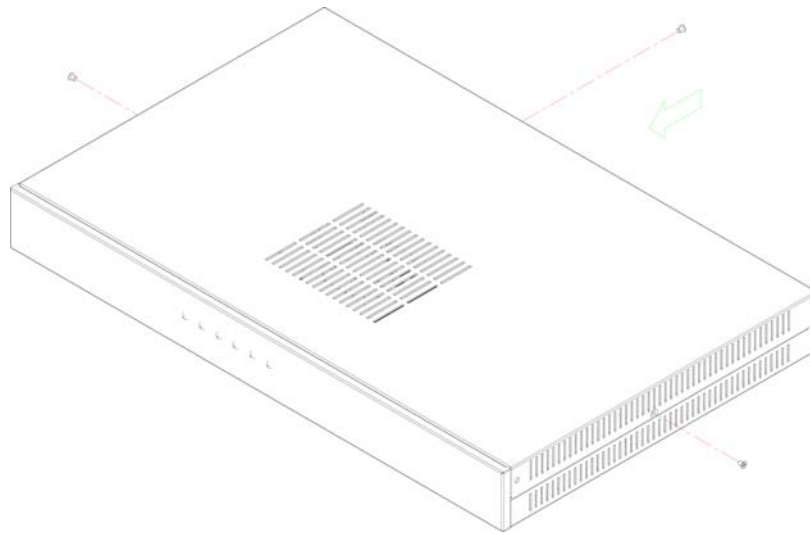

3.3 HDD and PCI Card Setup

1. Assemble HDD and its seat with 4 screws.

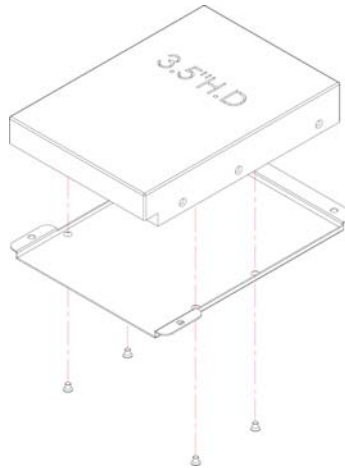

2. Place the whole HDD set on the chassis.

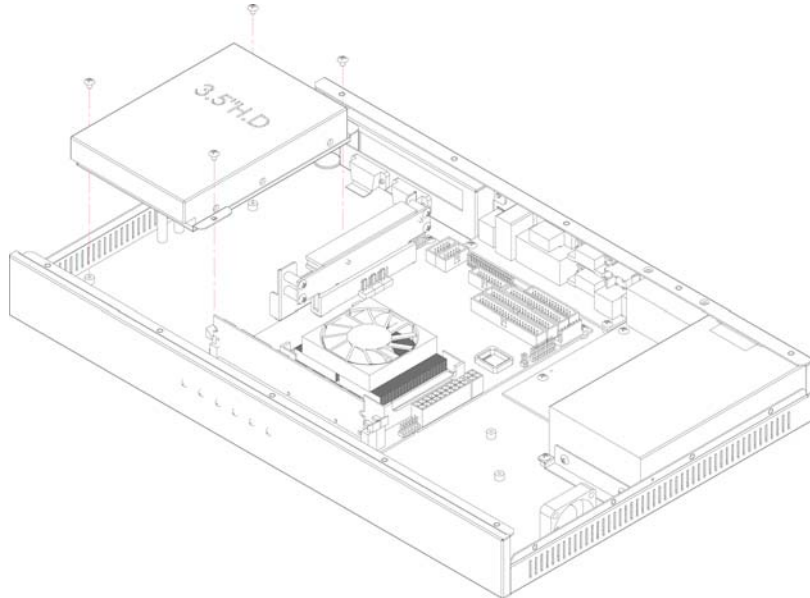

3. Insert PCI card to PCI extension slot, and fix it with a screw.

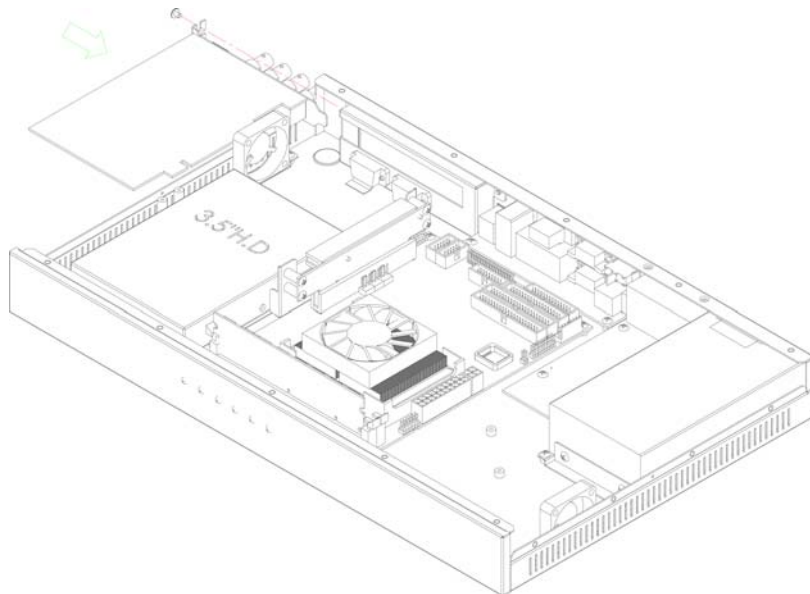

4. Screw the PCI stopper on the chassis

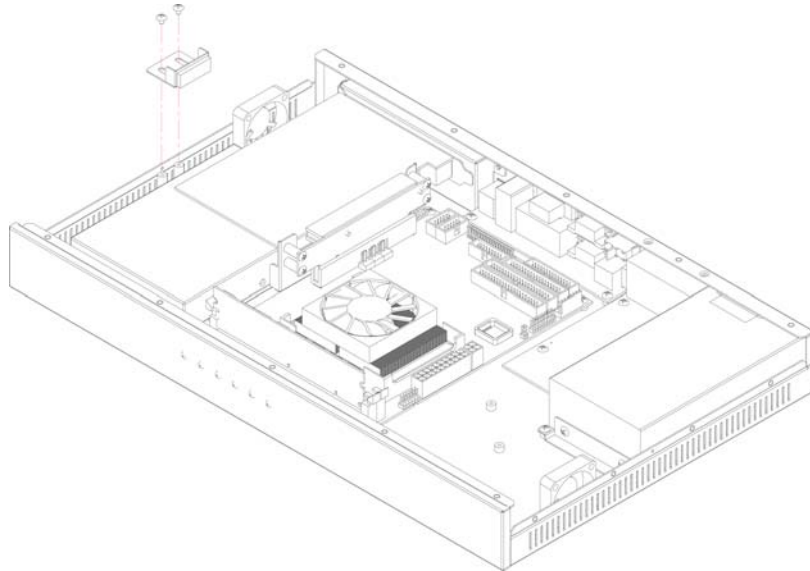

5. Completed assembly of HDD & PCI card as the following picture.

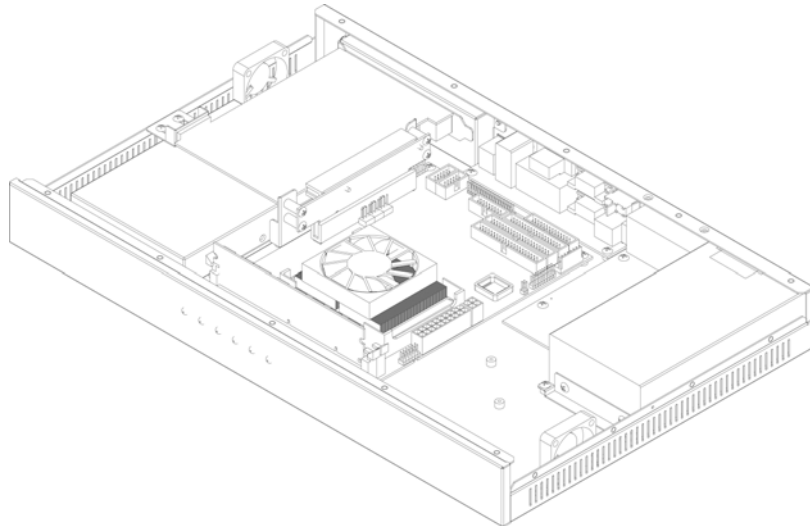

3.4 A-1048 Expansion Card Setup

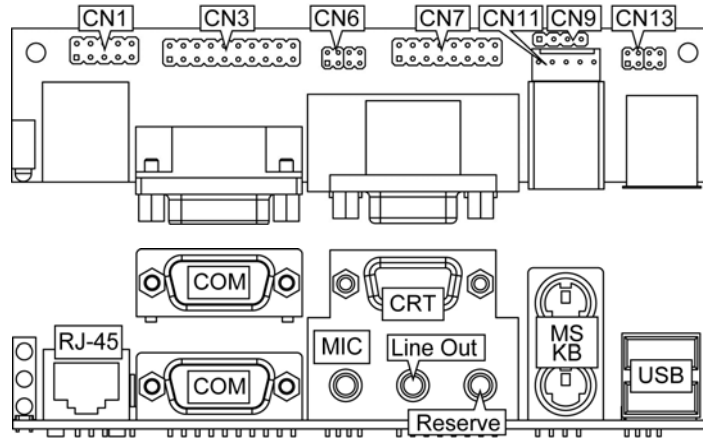

- **CN1: Internal LAN Connector (5x2 Header)**

PIN	Description	PIN	Description
1	VCC	2	LILED
3	RRX+	4	RRX-
5	ACTLED	6	LANC1
7	SPEEDLED	8	LANC2
9	TTX+	10	TTX-

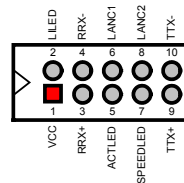

- **CN2: RJ-45 Connector**

- **CN3: Internal Serial Port Connector (10x2 Header)**

PIN	Description	PIN	Description
1	DCD1	2	DSR1
3	RXD1	4	RTS1
5	TXD1	6	CTS1
7	DTR1	8	RI1
9	GND	10	N/C
11	DCD2	12	DSR2
13	RXD2	14	RTS2
15	TXD2	16	CTS2
17	DTR2	18	RI2
19	GND	20	N/C

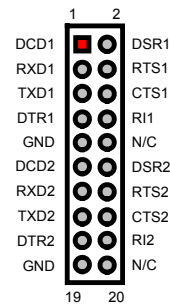

- **CN4: Dual Serial Port Connector (DB9)**

- **CN6: Internal MIC In/Audio Out Connector**

PIN	Description	PIN	Description
1	AOUT_L	2	AOUT_R
3	GND	4	GND
5	MIC_IN	6	N/C
7	GND	8	GND

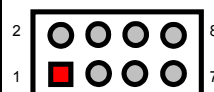

- **CN7: Internal CRT Connector (8x2 Header)**

PIN	Description	PIN	Description
1	Red	2	GND
3	Green	4	GND
5	Blue	6	GND
7	GND	8	DDCDTA
9	GND	10	HSYNC
11	GND	12	VSYNC
13	GND	14	DDCK
15	GND	16	N/C

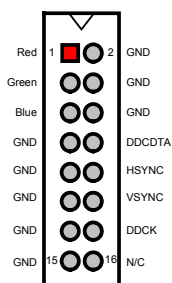

- **CN8: CRT Connector + Audio Jack Connector**

- **CN9: Internal Audio In Connector**

PIN	Description	PIN	Description
1	IN_R	2	GND
3	GND	4	IN_L

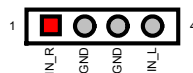

- **CN10: PS/2 6-pin Mini DIN Mouse Connector**

- **CN11: PS/2 6-pin Mini DIN Keyboard Connector**

- **CN12: Internal KB/MS Connector**

PIN	Description
1	VCC
2	MS_DATA
3	MS_CLK
4	KB_DATA
5	KB_CLK

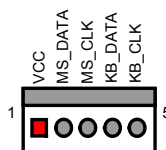

- **CN13: Internal USB Connector**

PIN	Description	PIN	Description
1	USBV0	2	USBV1
3	USBD0-	4	USBD1-
5	USBD0+	6	USBD1+
7	GND	8	GND

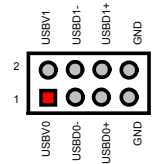

- **CN14: Dual USB Connector**

This page intentionally left blank.

Chapter 4

SBC Hardware Installation

This chapter provides the information on how to install the hardware using the HS-4701.

4.1 Before Installation

After confirming your package contents, you are now ready to install your hardware. The following are important reminders and steps to take before you begin with your installation process.

1. Make sure that all jumper settings match their default settings and CMOS setup correctly. Refer to the sections on this chapter for the default settings of each jumper.
2. Go through the connections of all external devices and make sure that they are installed properly and configured correctly within the CMOS setup. Refer to the sections on this chapter for the detailed information on the connectors.
3. Keep the manual and diskette in good condition for future reference and use.
4. Make sure your power supply is using for P4 only. One of 4-pin connector is for +12V lead which should connect to PW2 and 20-pin ATX connector to PW1.

4.2 Board Layout

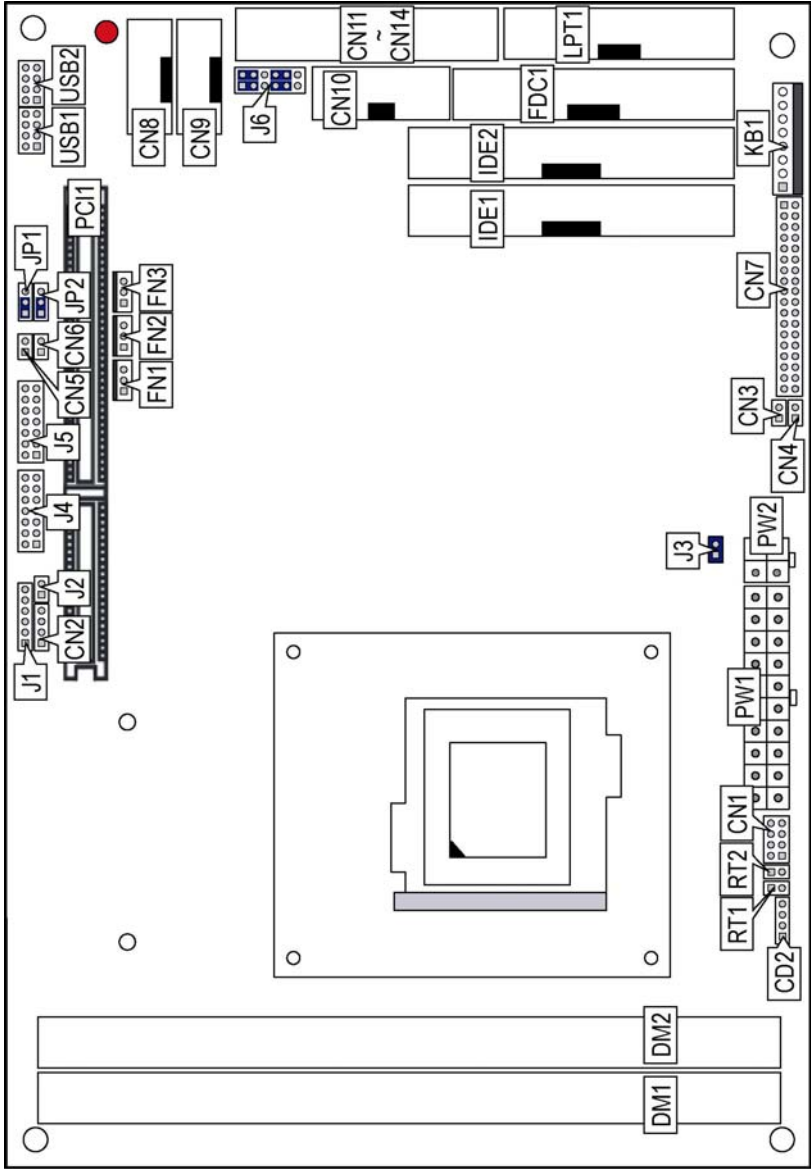

4.3 Jumper List

Jumper	Default Setting	Setting	Page
JP1	Bus Clock Rate Select: <i>Auto Detect</i>	Short 1-2	20
JP2	Clear CMOS: <i>Normal Operation</i>	Short 1-2	28
J3	Only for Debug	----	----
J6	Use RS-232 or RS-422/485 Select: <i>RS-232</i>	Short 1-3, 2-4, 7-9, 8-10	25

4.4 Connector List

Connector	Definition	Page
CN1	MIC In/Audio Out Connector	30
CD2	Line In Connector	30
CN2	External Speaker Connector	30
CN3	HDD LED Connector	29
CN4	2-pin ATX Power On/Off Switch	28
CN5	Reset Connector	29
CN6	Green LED Connector	29
CN7	Digital I/O Connector	31
CN8	Internal LAN Connector	27
CN9	RS-422/485 Connector	25
CN10	Internal CRT Connector	20
CN11	COM 1 Connector	25
CN12	COM 2 Connector	25
CN13	COM 3 Connector	25
CN14	COM 4 Connector	25
DM1/DM2	188-pin DDR Sockets	20
FDC1	FDD Connector	24
FN1/FN2/FN3	Fan Connectors	28
IDE1/IDE2	IDE Connectors	22
J1	Inverter Power Connector	20
J2	TV-Out Connector	31
J4	LVDS Connector	20
J5	LVDS Connector	20
J7	Mini AGP Connector	31
PW1	20-pin ATX Connector	28
PW2	4-pin ATX Connector	28
PCI1	PCI Expansion Slot	31
KB1	8-pin KB/MS Connector	29
LPT1	Parallel Connector	26
USB1/USB2	USB Connectors	27

4.5 Configuring the CPU

The HS-4701 offers the convenience in CPU installation with its auto-detect feature. After installing a new microprocessor onboard, the HS-4701 automatically identifies the frequency and clock speed of the installed microprocessor chip, thereby eliminating the need for user to do additional CPU configuration or hardware settings related to it.

- **JP1: Bus Clock Rate Select**

Options	Settings
Auto Detect (default)	Short 1-2
100MHz	Short 2-3
133MHz	Empty

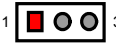

4.6 System Memory

The HS-4701 provides two DDR sockets at locations *DM1* and *DM2*. The maximum capacity of the onboard memory is 2GB.

4.7 VGA Controller

NOTE 1: *HS-4701 does not support DSTN/STN Panel.*

NOTE 2: *HS-4701 does not support 640*480 TFT Panel.*

NOTE 3: *There are specific panel cable and inverter for each different LCD. If clients need for others LCD (different from TOSHIBA LTM10C348F), please contact with your sales.*

The onboard Intel 82845GE with 1MB or 8MB memory supporting CRT display up to 1280 x 1024 at 32-bit colors. The HS-4701 provides two connection methods of CRT and LVDS Panel device. *CN10* offers an internal CRT connector, and *J4*, *J5* offer two LVDS Panel connectors.

● **CN10: Internal CRT Connector**

PIN	Description	PIN	Description
1	Red	2	GND
3	Green	4	GND
5	Blue	6	GND
7	GND	8	DDCDTA
9	GND	10	HSYNC
11	GND	12	VSYNC
13	GND	14	DDCK
15	GND	16	N/C

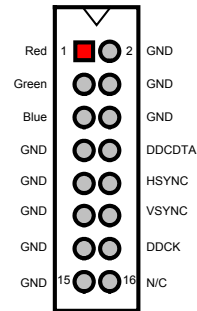

● **J1: Inverter Connector**

PIN.	Description
1	VCC12
2	VCC12
3	VCC5
4	ENABKL
5	ENAVDD
6	GND

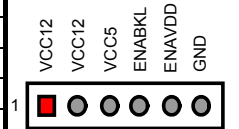

● **J4: LVDS Connector**

PIN	Description	PIN	Description
1	VCC3	2	VCC3
3	GND	4	GND
5	A4M	6	A4P
7	A5M	8	A5P
9	A6M	10	A6P
11	CLK2M	12	CLK2P
13	A7M	14	A7P

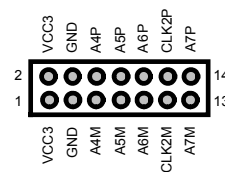

● **J5: LVDS Connector**

PIN	Description	PIN	Description
1	VCC3	2	VCC3
3	GND	4	GND
5	A0M	6	A0P
7	A1M	8	A1P
9	A2M	10	A2P
11	CLK1M	12	CLK1P
13	A3M	14	A3P

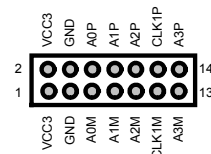

4.8 PCI E-IDE Drive Connector

IDE1 and *IDE2* are standard 40-pin connector daisy-chain driver connector serves the PCI E-IDE drive provisions onboard the HS-4701. A maximum of four ATA/33/66/100 IDE drives can connect to the HS-4701 via *IDE1* and *IDE2*.

- **IDE1: Primary IDE Connector**

PIN	Description	PIN	Description
1	IDERST#	2	GND
3	PDD7	4	PDD8
5	PDD6	6	PDD9
7	PDD5	8	PDD10
9	PDD4	10	PDD11
11	PDD3	12	PDD12
13	PDD2	14	PDD13
15	PDD1	16	PDD14
17	PDD0	18	PDD15
19	GND	20	N/C
21	PDREQ	22	GND
23	PDIOW#	24	GND
25	PDIOR#	26	GND
27	PIORDY	28	470Ω Pull GND
29	PDDACK#	30	GND
31	IRQ14	32	N/C
33	PDA1	34	P66DET
35	PDA0	36	PDA2
37	PDCS#1	38	PDCS#3
39	IDEACTP#	40	GND

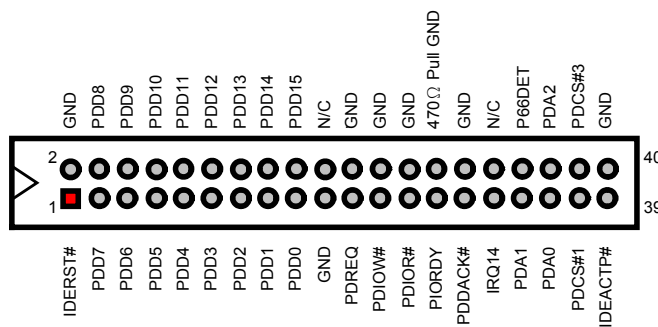

● IDE2: Secondary IDE Connector

PIN	Description	PIN	Description
1	IDERST#	2	GND
3	SDD7	4	SDD8
5	SDD6	6	SDD9
7	SDD5	8	SDD10
9	SDD4	10	SDD11
11	SDD3	12	SDD12
13	SDD2	14	SDD13
15	SDD1	16	SDD14
17	SDD0	18	SDD15
19	GND	20	N/C
21	SDREQ	22	GND
23	SDIOW#	24	GND
25	SDIOR#	26	GND
27	SIORDY	28	470Ω Pull GND
29	SDDACK#	30	GND
31	IRQ15	32	N/C
33	SDA1	34	S66DET
35	SDA0	36	SDA2
37	SDCS#1	38	SDCS#3
39	IDEACTP#	40	GND

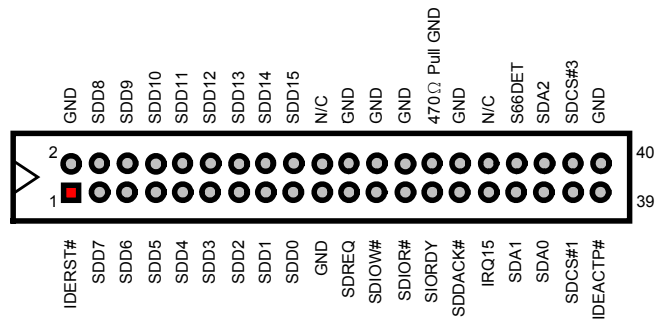

4.9 Floppy Disk Drive Connector

The HS-4701 uses a standard 34-pin header connector, *FDC1*, for floppy disk drive connection. A total of two FDD drives may be connected to *FDC* at any given time.

- **FDC1: FDD Connector**

PIN	Description	PIN	Description
1	GND	2	RWC#
3	GND	4	N/C
5	GND	6	DS1#
7	GND	8	Index#
9	GND	10	MOA#
11	GND	12	DSB#
13	GND	14	DSA#
15	GND	16	MOB#
17	GND	18	DIR#
19	GND	20	STEP#
21	GND	22	WD#
23	GND	24	WE#
25	GND	26	TRACK0#
27	GND	28	WP#
29	N/C	30	RDATA#
31	GND	32	HEAD#
33	N/C	34	DSKCHG#

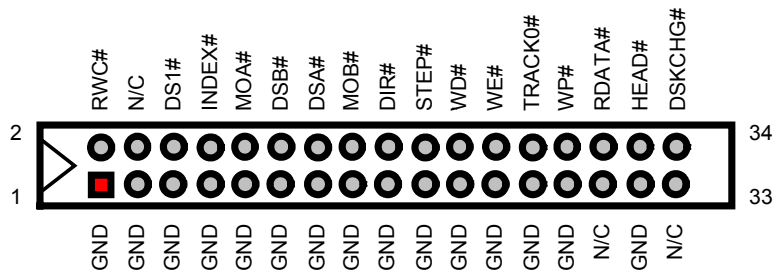

4.10 Serial Port Connectors

The HS-4701 offers two NS16C550 compatible UARTs with Read/Receive 16-byte FIFO serial ports and four internal 10-pin headers. There is one RS-422/485 connector.

- **CN11~CN14: COM1~COM4 Connectors (5x2 Header)**

PIN	Description	PIN	Description
1	DCD0	2	DSR0
3	RXDD0	4	RTS0
5	TXDD0	6	CTS0
7	DTR0	8	RI0
9	GND	10	N/C
11	DCD1	12	DSR1
13	RXDD1	14	RTS1
15	TXDD1	16	CTS1
17	DTR1	18	RI1
19	GND	20	N/C
21	DCD2	22	DSR2
23	RXDD2	24	RTS2
25	TXDD2	26	CTS2
27	DTR2	28	RI2
29	GND	30	N/C
31	DCD3	32	DSR3
33	RXDD3	34	RTS3
35	TXDD3	36	CTS3
37	DTR3	38	RI3
39	GND	40	N/C

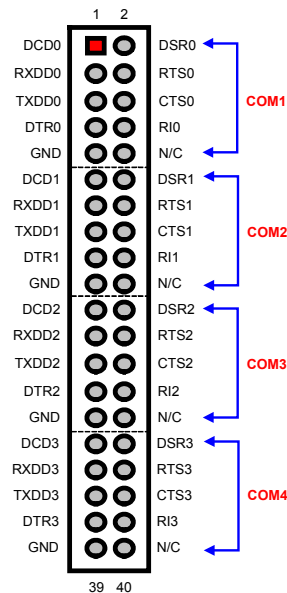

- **CN9: RS-422/485 Connector**

PIN	Description	PIN	Description
1	TX-	2	TX+
3	RX+	4	RX-
5	GND	6	RTS-
7	RTS+	8	CTS+
9	CTS-	10	N/C

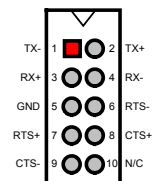

- **J6: Use RS-232 or RS-422/485 Select**

Options	Settings
RS-232 (default)	Short 1-3, 2-4, 7-9, 8-10
RS-422/485	Short 3-5, 4-6, 9-11, 10-12

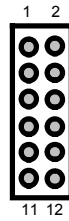

4.11 Parallel Connector

LPT1 is a standard 26-pin flat cable connector designed to accommodate parallel port connection onboard the HS-4701.

- **LPT1: Parallel Connector**

PIN	Description	PIN	Description
1	STB#	14	AFD#
2	PDR0	15	ERR#
3	PDR1	16	INIT#
4	PDR2	17	SLIN#
5	PDR3	18	GND
6	PDR4	19	GND
7	PDR5	20	GND
8	PDR6	21	GND
9	PDR7	22	GND
10	Acknowledge	23	GND
11	Busy	24	GND
12	Paper Empty	25	GND
13	Printer Select	26	N/C

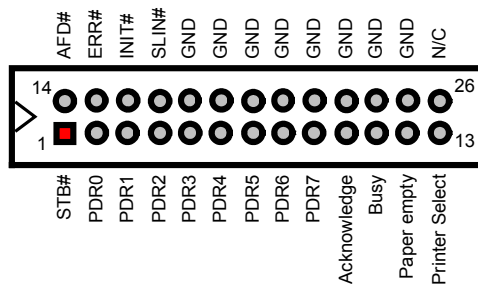

4.12 Ethernet Connector

The HS-4701 has Intel® 82562 10/100 Based LAN controller and provides one 10-pin internal connector. Please refer to the following for its pin information.

- **CN8: LAN Connector (Intel 82562)**

PIN	Description	PIN	Description
1	3.3VSTBY	2	LILED#
3	RRX+	4	RRX-
5	ACTLED#	6	LANC1
7	SPLED#	8	LANC2
9	TTX+	10	TTX-

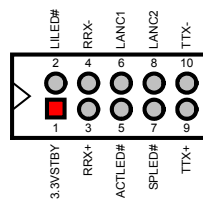

4.13 USB Connector

The HS-4701 provides four USB ports, at locations *USB1* and *USB2*, for four USB connections to the HS-4701.

- **USB1: USB Connector**

PIN	Description	PIN	Description
1	VCC	2	VCC
3	USBP0N	4	USBP1N
5	USBP0P	6	USBP1P
7	GND	8	GND

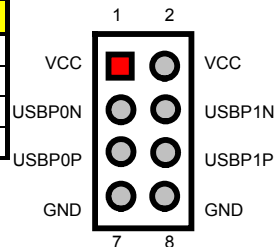

- **USB2: USB Connector**

PIN	Description	PIN	Description
1	VCC	2	VCC
3	USBP2N	4	USBP3N
5	USBP2P	6	USBP3P
7	GND	8	GND

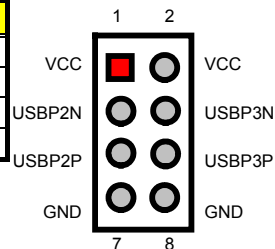

4.14 CMOS Data Clear

The HS-4701 has a Clear CMOS jumper on JP2.

- **JP2: Clear CMOS**

Options	Settings
Normal Operation (default)	Short 1-2
Clear CMOS	Short 2-3

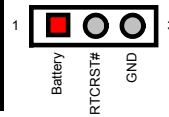

IMPORTANT: Before you turn on the power of your system, please set JP2 to short 1-2 for normal operation.

4.15 Power and Fan Connectors

HS-4701 provides one 20-pin and one 4-pin ATX power connectors at PW1 and PW2.

HS-4701 must using P4 power supply. One of 4-pin connector is for +12V lead which should connect to PW2.

20-pin ATX Power Connector can connect to Backplane or to PW1.

- **PW2: 4-pin ATX Power In Connector**

PIN	Description	PIN	Description
1	GND	2	GND
3	+12V	4	+12V

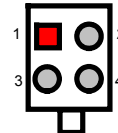

- **PW1: 20-pin ATX Power In Connector**

PIN	Description	PIN	Description
1	+3.3V	11	+3.3V
2	+3.3V	12	-12V
3	GND	13	GND
4	+5V	14	PS_ON
5	GND	15	GND
6	+5V	16	GND
7	GND	17	GND
8	PWROK	18	-5V
9	5VSB	19	+5V
10	+12V	20	+5V

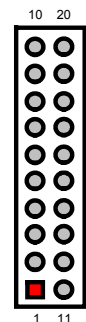

- **CN4: 2-pin ATX Power On/Off Switch**

PIN	Description
1	5VSTBY
2	Power On/Off



Connector *FN1*, *FN2* and *FN3* onboard HS-4701 are 3-pin fan connectors.

- **FN1, FN2 and FN3: Fan Connectors**

PIN	Description
1	GND
2	+12V
3	Fan Speed

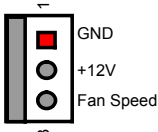

4.16 Keyboard/Mouse Connectors

The HS-4701 offers one possibility for keyboard/mouse connection is via *KB1*.

- **KB1: 8-pin Keyboard/Mouse Connector**

PIN	Description
1	GND
2	VCC
3	MS_DATA
4	MS_CLK
5	GND
6	VCC
7	KB_DATA
8	KB_CLK

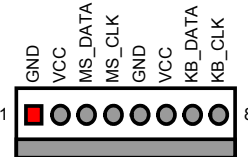

4.17 System Front Panel Connectors

The HS-4701 has one LED at location *CN3* that indicates the HDD status.

- **CN3: HDD LED Connector**

PIN	Description
1	150Ω Pull +5V
2	HDD ACTIVE#

CN5 is the Reset Button connector onboard. The *CN6* is Green function LED indicates.

- **CN5: Reset Button Connector**

PIN	Description
1	GND
2	External Reset

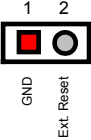

- **CN6: Green LED Connector**

PIN	Description
1	150Ω Pull +5V
2	ACTIVE#

4.18 External Speaker

Aside from the buzzer at location *BZ1* onboard, the HS-4701 also offers a connector (*CN2*) for an external speaker connection. The table below lists the pin assignments of *CN2*.

- **CN2: External Speaker Connector**

PIN	Description
1	VCC
2	GND
3	GND
4	Speaker Signal

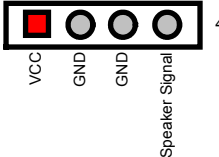

4.19 Audio Connectors

The HS-4701 has an onboard AC97 3D audio interface. The following table list the pin assignments of the MIC In / Audio Out and Line In connector.

- **CN1: MIC In / Audio Out Connector**

PIN	Description	PIN	Description
1	AOUT_L	2	AOUT_R
3	GND	4	GND
5	MIC_IN	6	N/C
7	GND	8	GND

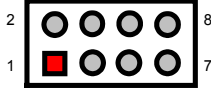

- **CD2: Line In Connector**

PIN	Description	PIN	Description
1	IN_R	2	GND
3	GND	4	IN_L

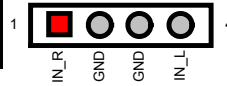

4.20 Digital Input/Output

The HS-4701 provides a CN7 connector for Digital I/O function.

- **CN7: Digital I/O Connector**

PIN	Description	PIN	Description
1	VCC5	2	VCC5
3	DO_0	4	DI_0
5	DO_1	6	DI_1
7	DO_2	8	DI_2
9	DO_3	10	DI_3
11	DO_4	12	DI_4
13	DO_5	14	DI_5
15	DO_6	16	DI_6
17	DO_7	18	DI_7
19	DO_8	20	DI_8
21	DO_9	22	DI_9
23	DO_10	24	DI_10
25	DO_11	26	DI_11
27	DO_12	28	DI_12
29	DO_13	30	DI_13
31	DO_14	32	DI_14
33	DO_15	34	DI_15
35	GND	36	GND

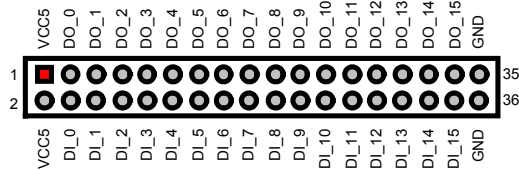

4.21 TV Out Function

HS-4701 can support TV-Out function which input could be up to 800 x 600 graphics resolutions. World Wide Video standards are supported including NTSC-M (North America, Taiwan), NTSC-J (Japan), PAL-B, D, G, H, I (Europe, Asia), PAL-M (Brazil), PAL-N (Uruguay, Paraguay) and PAL-NC (Argentina).

- **J2: TV-Out Connector**

PIN	Description	PIN	Description
1	GND	2	TVCVB

4.22 Mini AGP Connector

HS-4701 provides one Mini AGP expansion slot, has at location J7, you can use slot for expansion when necessary.

4.23 PCI Expansion Slot

HS-4701 provides one standard PCI expansion slot at PCI1.

Chapter 5

Award BIOS Setup

The HS-4701 uses Award BIOS for the system configuration. The Award BIOS setup program is designed to provide the maximum flexibility in configuring the system by offering various options that could be selected for end-user requirements. This chapter is written to assist you in the proper usage of these features.

5.1 Starting Setup

The Award BIOS is immediately activated when you first power on the computer. The BIOS reads the system information contained in the CMOS and begins the process of checking out the system and configuring it. When it finishes, the BIOS will seek an operating system on one of the disks and then launch and turn control over to the operating system.

While the BIOS is in control, the Setup program can be activated in one of two ways:

1. By pressing immediately after switching the system on, or
2. By pressing the key when the following message appears briefly at the bottom of the screen during the POST (Power On Self Test).

Press DEL to enter SETUP.

If the message disappears before you respond and you still wish to enter Setup, restart the system to try again by turning it OFF then ON or pressing the "RESET" button on the system case. You may also restart by simultaneously pressing <Ctrl>, <Alt>, and <Delete> keys. If you do not press the keys at the correct time and the system does not boot, an error message will be displayed and you will again be asked to...

PRESS F1 TO CONTINUE, DEL TO ENTER SETUP

5.2 Using Setup

In general, you use the arrow keys to highlight items, press <Enter> to select, use the <PageUp> and <PageDown> keys to change entries, press <F1> for help and press <Esc> to quit. The following table provides more detail about how to navigate in the Setup program using the keyboard.

Up arrow	Move to previous item
Down arrow	Move to next item
Left arrow	Move to the item in the left hand
Right arrow	Move to the item in the right hand
Esc key	Main Menu -- Quit and not save changes into CMOS Status Page Setup Menu and Option Page Setup Menu -- Exit current page and return to Main Menu
PgUp key	Increase the numeric value or make changes
PgDn key	Decrease the numeric value or make changes
+ key	Increase the numeric value or make changes
- key	Decrease the numeric value or make changes
F1 key	General help, only for Status Page Setup Menu and Option Page Setup Menu
(Shift)F2 key	Change color from total 16 colors. F2 to select color forward, (Shift) F2 to select color backward
F3 key	Calendar, only for Status Page Setup Menu
F4 key	Reserved
F5 key	Restore the previous CMOS value from CMOS, only for Option Page Setup Menu
F6 key	Load the default CMOS value from BIOS default table, only for Option Page Setup Menu
F7 key	Load the default
F8 key	Reserved
F9 key	Reserved
F10 key	Save all the CMOS changes, only for Main Menu

5.2.1 Getting Help

Press F1 to pop up a small help window that describes the appropriate keys to use and the possible selections for the highlighted item. To exit the Help Window press <Esc> or the F1 key again.

5.3 Main Menu

Once you enter the Award BIOS CMOS Setup Utility, the Main Menu will appear on the screen. The Main Menu allows you to select from several setup functions and two exit choices. Use the arrow keys to select among the items and press <Enter> to enter the sub-menu.

Phoenix – AwardBIOS CMOS Setup Utility		
▶ Standard CMOS Features	▶ Frequency/Voltage Control	
▶ Advanced BIOS Features	Load Fail-Safe Defaults	
▶ Advanced Chipset Features	Load Optimized Defaults	
▶ Integrated Peripherals	Set Supervisor Password	
▶ Power Management Setup	Set User Password	
▶ PnP/PCI Configurations	Save & Exit Setup	
▶ PC Health Status	Exit Without Saving	
Esc : Quit	F9 : Menu in BIOS	↑↓→← : Select Item
F10 : Save & Exit Setup		
Time, Date, Hard Disk Type...		

NOTE: *A brief description of the highlighted choice appears at the bottom of the screen.*

5.4 Standard CMOS Setup

The Standard Setup is used for the basic hardware system configuration. The main function is for Data/Time and Floppy/Hard Disk Drive settings. Please refer to the following screen for the setup. When the IDE hard disk drive you are using is larger than 528MB, you must set the HDD mode to **LBA** mode. Please use the IDE Setup Utility in BIOS SETUP to install the HDD correctly.

Phoenix – AwardBIOS CMOS Setup Utility		
Standard CMOS Features		
Date (mm:dd:yy)	Wed, Oct 31 2001	Item Help
Time (hh:mm:ss)	10 : 32 :57	Menu Level ▶
▶ IDE Primary Master		Change the day, month, year and century
▶ IDE Primary Slave		
▶ IDE Secondary Master		
▶ IDE Secondary Slave		
Drive A	[1.44M, 3.5in.]	
Drive B	[None]	
Video	[EGA/VGA]	
Halt On	[All, But Keyboard]	
Base Memory	640K	
Extended Memory	65472K	
Total Memory	1024K	
↑↓→←: Select Item + / - /PU/PD: Value F10: Save ESC: Quit F1: General Help F5: Previous Values F6: Fail-Safe Defaults F7: Optimized Defaults		

5.5 Advanced CMOS Setup

This section allows you to configure your system for the basic operation. You have the opportunity to select the system's default speed, boot-up sequence, keyboard operation, shadowing and security.

Phoenix – AwardBIOS CMOS Setup Utility Advanced BIOS Features

Virus Warning	[Disabled]	Item Help
CPU L1& L2 Cache	[Enabled]	Menu Level ►
Hyper-Threading	[Enabled]	
Quick Power On Self Test	[Enabled]	
First Boot Device	[Floppy]	Allows you to choose
Second Boot Device	[HDD-0]	the VIRUS warning
Third Boot Device	[LS120]	feature for IDE Hard
Boot Other Device	[Enabled]	Disk boot sector
Swap Floppy Drive	[Disabled]	protection. If this
Boot Up Floppy Seek	[Enabled]	function is enabled
Boot Up Num Lock Status	[On]	and someone attempt to
Gate A20 Option	[Fast]	write data into this
Typematic Rate Setting	[Disabled]	area, BIOS will show
Typematic Rate (Chars/Sec)	6	a warning message on
Typematic Delay (Msec)	250	screen and alarm beep
Security Option	[Setup]	
APIC Mode	[Enabled]	
MPS Version Control For OS	[1.4]	
OS Select For DRAM > 64MB	[Non-OS2]	
Report No FDD for WIN95	[NO]	
Small Logo (EPA) Show	[Enabled]	
↑↓→←: Select Item + / - /PU/PD: Value F10: Save ESC: Quit F1: General Help F5: Previous Values F6: Fail-Safe Defaults F7: Optimized Defaults		

5.6 Advanced Chipset Setup

This section allows you to configure the system based on the specific features of the installed chipset. This chipset manages bus speeds and the access to the system memory resources, such as DRAM and the external cache. It also coordinates the communications between the conventional ISA and PCI buses. It must be stated that these items should never be altered. The default settings have been chosen because they provide the best operating conditions for your system. You might consider and make any changes only if you discover that the data has been lost while using your system.

Phoenix – AwardBIOS CMOS Setup Utility Advanced Chipset Features

DRAM Timing Selectable	[By SPD]	Item Help
CAS Latency Time	[1.5]	Menu Level ▶
Active to Precharge Delay	[7]	
DRAM RAS# to CAS# Delay	[3]	
DRAM RAS# Precharge	[3]	
Turbo Mode	[Disabled]	
Memory Frequency For	[Auto]	
System BIOS Cacheable	[Enabled]	
Video BIOS Cacheable	[Enabled]	
Memory Hole At 15M-16M	[Disabled]	
Delayed Transaction	[Enabled]	
Delay Prior to Thermal	[16Min]	
AGP Aperture Size (MB)	[64]	
** ON-chip VGA Setting **		
On-chip VGA	[Enabled]	
On-chip Frame Buffer size	[8MB]	
Boot Display	[CRT]	
Panel Scaling	[Auto]	
Panel Number	[1]	
↑↓→←: Select Item + / - /PU/PD: Value F10: Save ESC: Quit F1: General Help F5: Previous Values F6: Fail-Safe Defaults F7: Optimized Defaults		

NOTE: Panel Number: 1 (Default Panel 1: TOSHIBA LTM10C348F)

5.7 Power Management Setup

The Power Management Setup allows user to configure the system for saving energy in a most effective way while operating in a manner consistent with his own style of computer use.

Phoenix – AwardBIOS CMOS Setup Utility Power Management Setup

ACPI function	[Enabled]	Item Help
ACPI Suspend Type	[S1(POS)]	Menu Level ►
Run VGABIOS id S3 Resume	Auto	
Power Management	[Use Define]	
Video off Method	[DPMS]	
Video off In Suspend	[Yes]	
Suspend Type	[Stop Grant]	
MODEM Use IRQ	[Modify]	
Suspend Mode	[Disabled]	
HDD Power Down	[Disabled]	
Soft-off by PWR-BTTN	[Instant-Off]	
CPU THRM-throttling	[50.00%]	
Wake-up by PCI card	[Enabled]	
Power On by Ring	[Enabled]	
USB KB Wake-up From S3	Disabled	
Resume by Alarm	[Disabled]	
Date(of Month) Alarm	0	
Time(hh:mm:ss) Alarm	0:0:0	
** Reload Global Timer Events **		
Primary IDE 0	[Disabled]	
Primary IDE 1	[Disabled]	
Secondary IDE 0	[Disabled]	
Secondary IDE 1	[Disabled]	
FDD, COM, LPT Port	[Disabled]	
PCI PIRQ[A-D]#	[Disabled]	
↑↓→←: Select Item + / - /PU/PD: Value F10: Save ESC: Quit F1: General Help F5: Previous Values F6: Fail-Safe Defaults F7: Optimized Defaults		

5.8 PCI / Plug and Play Setup

This section describes configuring the PCI bus system. PCI, or Personal Computer Interconnect, is a system that allows I/O devices to operate at speeds nearing the speed the CPU itself uses when communicating with its own special components. This section covers some very technical items and it is strongly recommended that only experienced users should make any changes to the default settings.

Phoenix – AwardBIOS CMOS Setup Utility PnP/PCI Configurations

PNP OS Installed	[No]	Item Help
Reset Configuration Data	[Disabled]	Menu Level ►
Resources Controlled By	[Auto(ESCD)]	Select Yes if you are using a plug and play capable operating system. Select No if you need the BIOS to configure non-boot devices
IRQ Resources	Press Enter	
DMA Resources	Press Enter	
PCI/VGA Palette Snoop	[Disabled]	
↑↓→←: Select Item + / - /PU/PD: Value F10: Save ESC: Quit F1: General Help F5: Previous Values F6: Fail-Safe Defaults F7: Optimized Defaults		

5.9 Peripheral Setup

The IDE hard drive controllers can support up to four separate hard drives. These drives have a master/slave relationship that is determined by the cabling configuration used to attach them to the controller. Your system supports two IDE controllers--a primary and a secondary--so you can install up to four separate hard disks.

Phoenix – AwardBIOS CMOS Setup Utility Integrated Peripherals

On-chip Primary PCI IDE	[Enabled]	Item Help
IDE Primary Master PIO	[Auto]	Menu Level ▶
IDE Primary Slave PIO	[Auto]	
IDE Primary Master UDMA	[Auto]	
IDE Primary Slave UDMA	[Auto]	
On-chip Secondary PCI IDE	[Enabled]	
IDE Secondary Master PIO	[Auto]	
IDE Secondary Slave PIO	[Auto]	
IDE Secondary Master UDMA	[Auto]	
IDE Secondary Slave UDMA	[Auto]	
USB Controller	[Enabled]	
USB 2.0 Controller	[Enabled]	
USB Keyboard Support	[Disabled]	
USB Mouse Support	[Disabled]	
AC97 Audio	[Auto]	
Init Display First	[PCI Slot]	
IDE HDD Block Mode	[Enabled]	
POWER ON Function	[BUTTON ONLY]	
KB Power ON Password	[Enter]	
Hot Key Power On	[Ctrl-F1]	
Onboard FDC Controller	[Enabled]	
Onboard Serial Port 1	[3F8/IRQ4]	
Onboard Serial Port 2	[2F8/IRQ3]	
UART Mode Select	[Normal]	
RxD, TxD Active	[Hi, Lo]	
IR Transmission delay	[Enabled]	
UR2 Duplex Mode	[Half]	
Use IR Pins	[IR-RX2TX2]	
Onboard Parallel Port	[378/IRQ7]	
Parallel Port Mode	[SPP]	
EPP Mode Select	[EPP1.7]	
ECP Mode Use DMA	[3]	
PWRON After PWR-Fail	[Off]	
Midi Port Address	[330]	
Midi Port IRQ	[5]	
Onboard Serial Port 3	[3E8]	
Serial Port 3 Use IRQ	IRQ10]	
Onboard Serial Port 4	[2E8]	
Serial Port 4 Use IRQ	[IRQ11]	
↑↓→←: Select Item + / - /PU/PD: Value F10: Save ESC: Quit F1: General Help F5: Previous Values F6: Fail-Safe Defaults F7: Optimized Defaults		

5.10 PC Health Status

Phoenix – AwardBIOS CMOS Setup Utility PC Health Status

CPU Warning Temperature	[Disabled]	Item Help
Current System Temp.		Menu Level ▶
Current CPU1 Temperature		
Current CPUFAN1 Speed		
Current CPUFAN2 Speed		
Current CPUFAN3 Speed		
IN0(V)		
IN1(V)		
IN2(V)		
+5V		
+12V		
-12V		
-5V		
VBAT(V)		
5VSB(V)		
Shutdown Temperature	[Disabled]	
↑↓→←: Select Item + / - /PU/PD: Value F10: Save ESC: Quit F1: General Help F5: Previous Values F6: Fail-Safe Defaults F7: Optimized Defaults		

5.11 Frequency/Voltage Control

Phoenix – AwardBIOS CMOS Setup Utility Frequency/Voltage Control

CPU Clock Ratio	[Auto (Modify)]	Item Help
Auto Detect PCI Clk	[Enabled]	Menu Level ▶
Spread Specturm	[Disabled]	
↑↓→←: Select Item + / - /PU/PD: Value F10: Save ESC: Quit F1: General Help F5: Previous Values F6: Fail-Safe Defaults F7: Optimized Defaults		

Chapter 6

Software Utilities

This chapter contains the detailed information of IDE, VGA, LAN and Audio driver installation procedures. The utility disk that came with the delivery package contains an auto-run program that invokes the installation programs for the VGA, LAN and Audio drivers. The following sections describe the installation procedures of each driver based on Win 95/98, Win 2000 and Win NT operating systems. It is recommended that you install the drivers matching the sections listed in this chapter.

6.1 IDE Driver Installation

6.1.1 Installing Intel Chipset Software Utility

1. Insert Utility CD Disk to your CD ROM drive. The main menu will pop up as shown below. Select on the **HS-4701** button to launch the installation program.
2. Click on the **ICH4 Driver** button to continue.

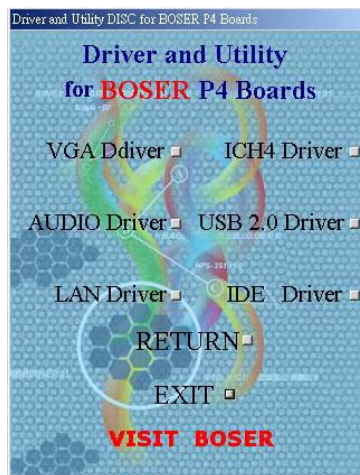

3. Immediately after clicking the IDE button in Step 1, the program launches the InstallShield Wizard that will assist you in the installation process. Click on the **Next >** button to proceed.

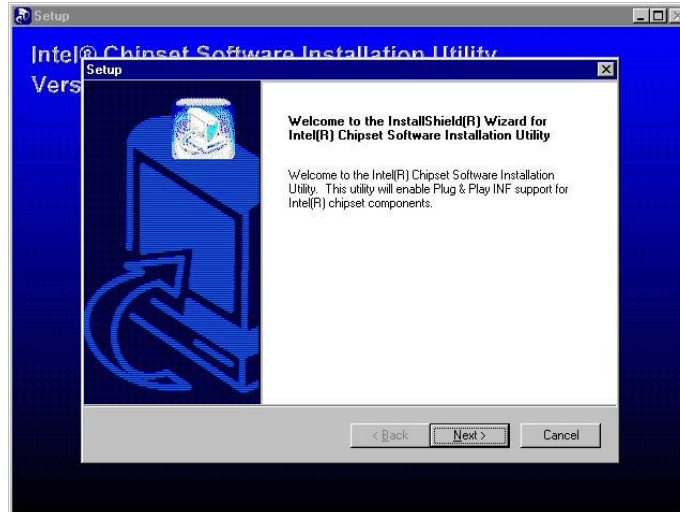

4. The Intel OEM Software License Agreement dialog box then appears on the screen. Choose **Yes** to proceed.

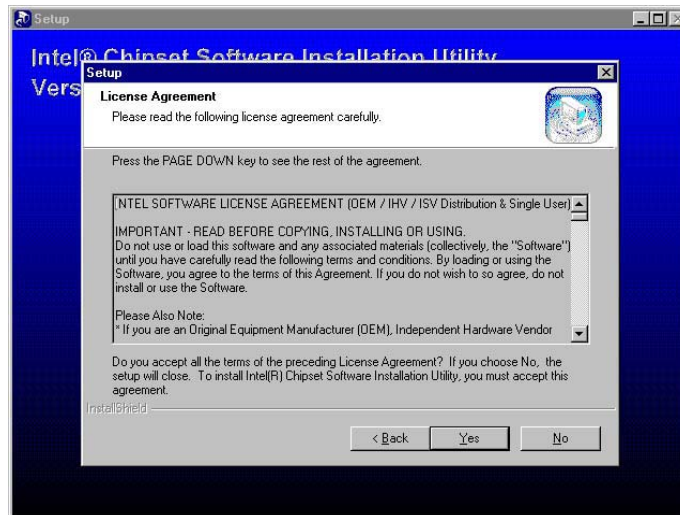

5. When the Readme Information dialog box pops up, just click on the **Next** button to proceed.

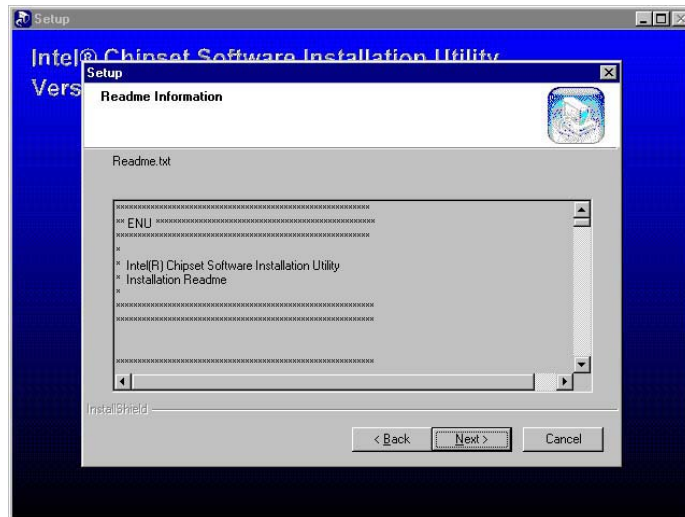

6. Once the Install Shield Wizard finishes updating your system, it will prompt you to restart the computer. Tick on the **Yes, I want to restart my computer now** followed by a click on the **Finish** button to reboot. Only after your computer boots will the new settings take effect.

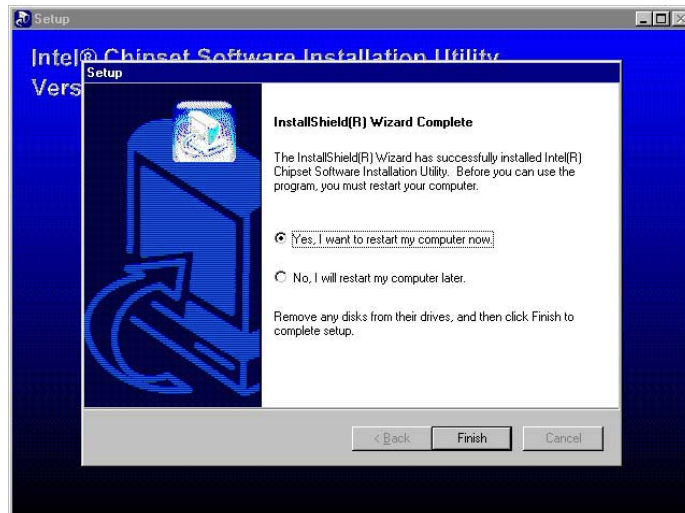

6.1.2 Installing Intel Application Accelerator

1. Insert Utility CD Disk to your CD ROM drive. The main menu will pop up as shown below. Select on the **HS-4701** button to launch the installation program.
2. Click on the **IDE Driver** button to continue.

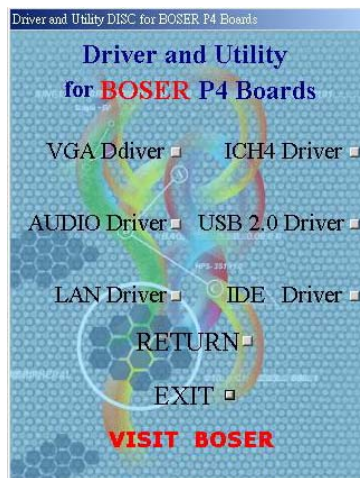

3. When the dialog box below appears, make sure you close all other Windows applications then click on the **Next >** button to proceed.

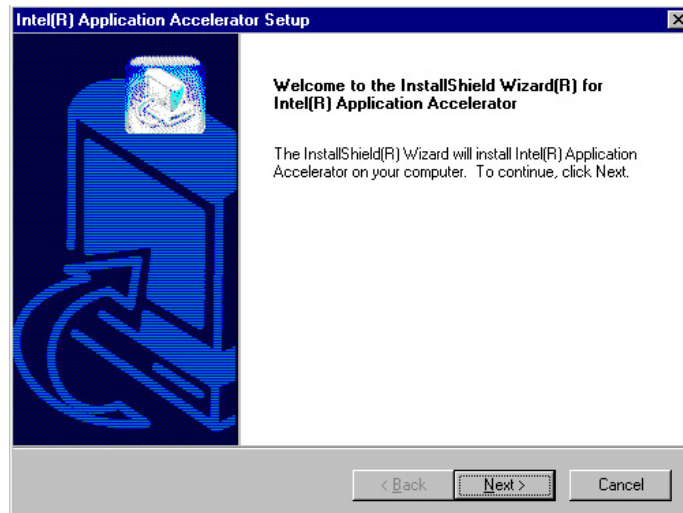

- The Intel OEM Software License Agreement dialog box then appears on the screen. Choose **Yes** to proceed.

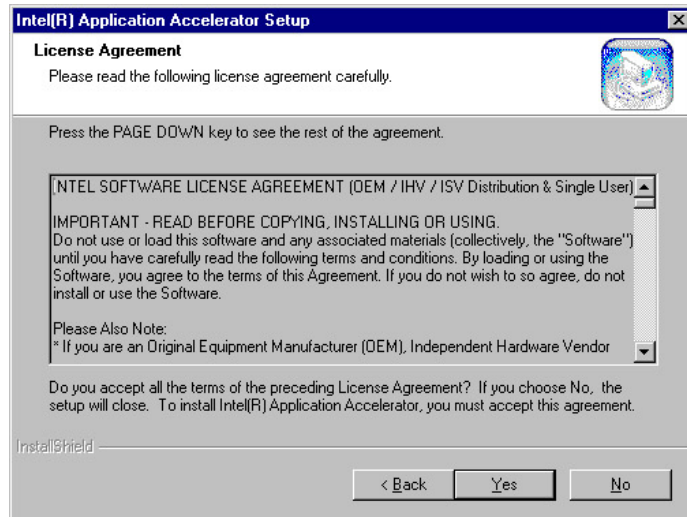

- Setup will then prompt you to specify the path where you would like the Security driver installed. Select the **Next >** button after you have made your path/installation choice.

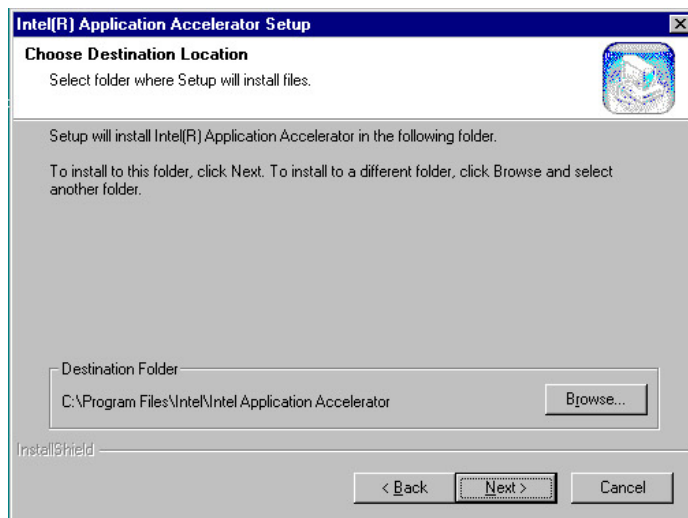

6. Once the setup program finishes copying files into your system, it will prompt you to restart the computer. Tick on the **Yes, I want to restart my computer now** followed by a click on the **Finish** button to reboot. Only after your computer boots will the new settings take effect.



6.2 VGA Driver Installation

6.2.1 Win 98

1. Insert Utility CD Disk to your CD ROM drive. The main menu will pop up as shown below. Select on the **HS-4701** button to launch the installation program.
2. Click on the **VGA Driver** button to continue.

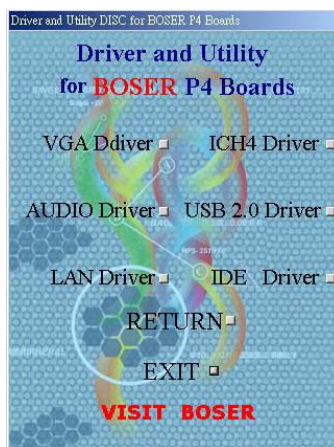

3. Click on the **Windows 9x** button to continue.

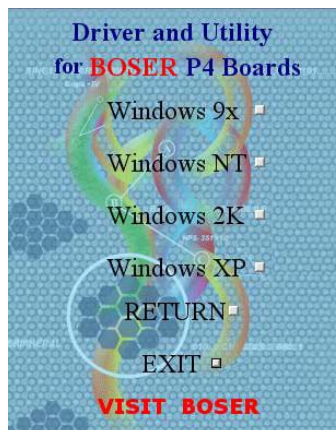

4. When the dialog box below appears, make sure you close all other Windows applications then click on the **N**ext > button to proceed.

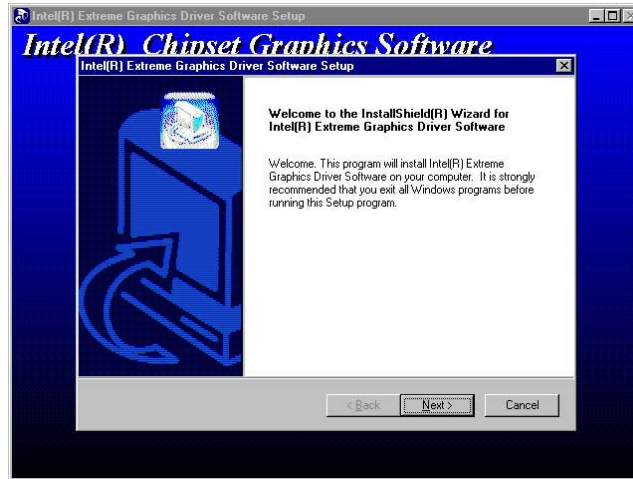

5. The Intel OEM Software License Agreement dialog box then appears on the screen. Choose **Y**es to proceed.

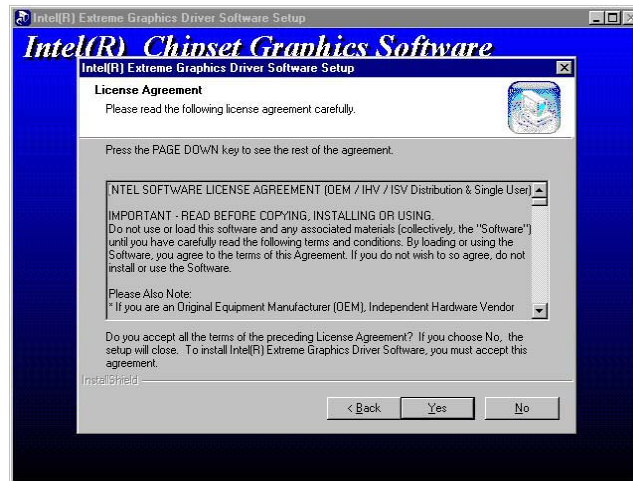

6. Once the setup program finishes copying files into your system, it will prompt you to restart the computer. Tick on the **Yes, I want to restart my computer now** followed by a click on the **Finish** button to reboot. Only after your computer boots will the new settings take effect.

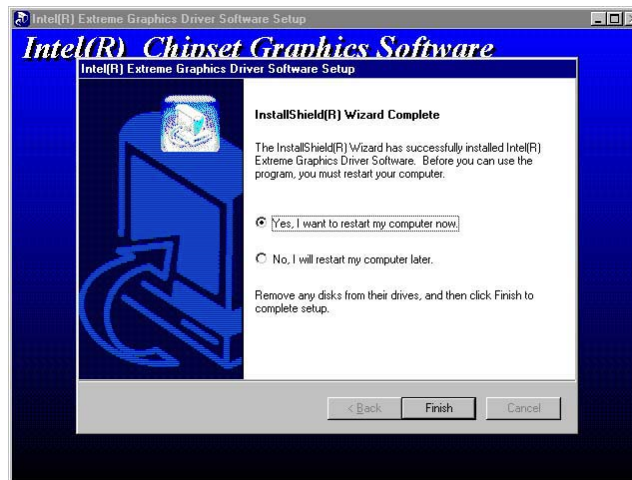

NOTE: *Installation procedure for Windows 98 is similar to Windows95.*

6.2.2 Win NT

NOTE: Please make sure you have already install *Service Pack 6.0*.

1. Insert Utility CD Disk to your CD ROM drive. The main menu will pop up as shown below. Select on the **HS-4701** button to launch the installation program.
2. Click on the **VGA Driver** button to continue.

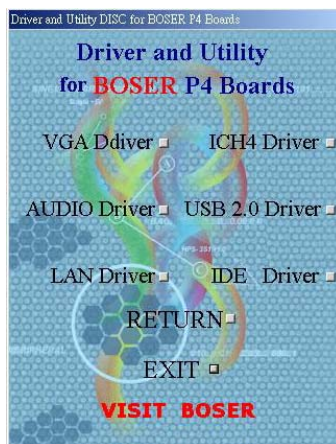

3. Click on the **Windows NT** button to continue.

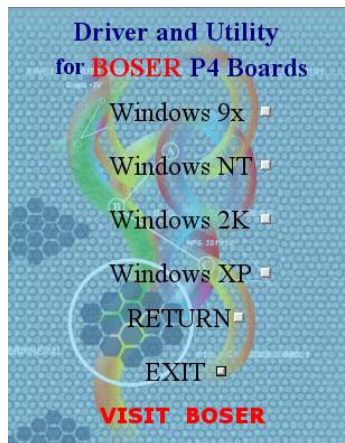

4. When the dialog box below appears, make sure you close all other Windows applications then click on the **Next >** button to proceed.



5. The Intel OEM Software License Agreement dialog box then appears on the screen. Choose **Yes** to proceed.

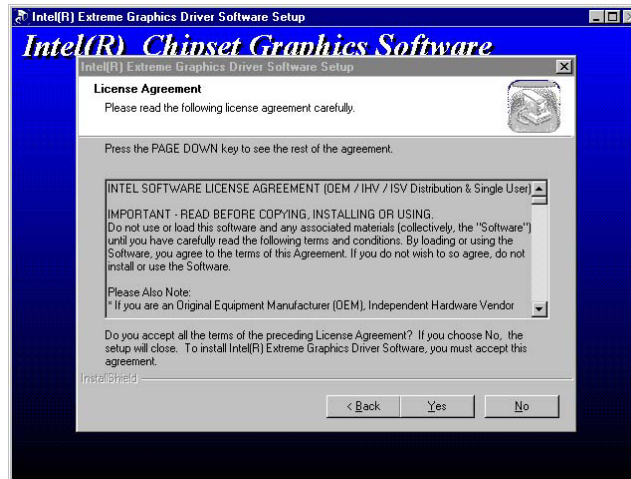

6. Once the setup program finishes copying files into your system, it will prompt you to restart the computer. Tick on the **Yes, I want to restart my computer now** followed by a click on the **Finish** button to reboot. Only after your computer boots will the new settings take effect.

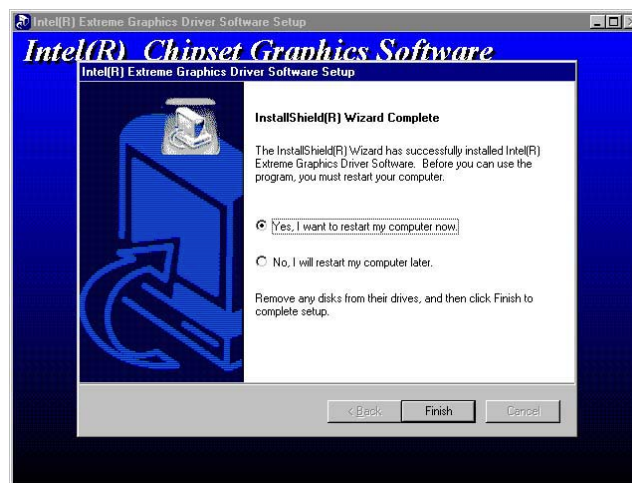

6.2.3 Win 2000

1. Insert Utility CD Disk to your CD ROM drive. The main menu will pop up as shown below. Select on the **HS-4701** button to launch the installation program.
2. Click on the **VGA Driver** button to continue.

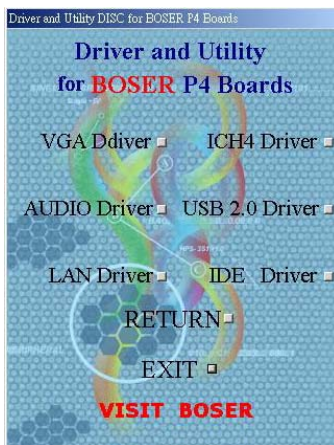

3. Click on the **Windows 2K** button to continue.

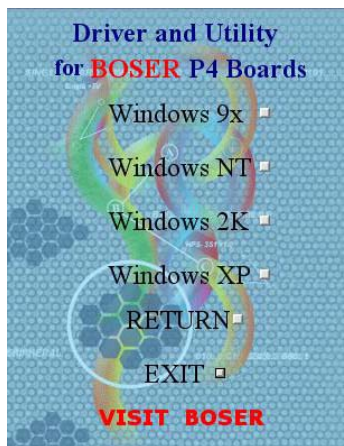

4. When the dialog box below appears, make sure you close all other Windows applications then click on the **N**ext > button to proceed.



5. The Intel OEM Software License Agreement dialog box then appears on the screen. Choose **Y**es to proceed.

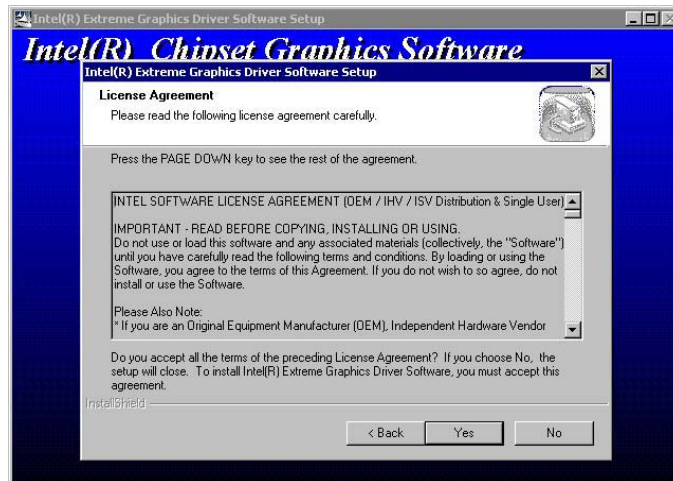

6. Once the setup program finishes copying files into your system, it will prompt you to restart the computer. Tick on the **Yes, I want to restart my computer now** followed by a click on the **Finish** button to reboot. Only after your computer boots will the new settings take effect.



6.3 LAN Driver Installation

6.3.1 Win 95/98

1. Insert Utility CD Disk to your CD ROM drive. The main menu will pop up as shown below. Select on the **HS-4701** button to launch the installation program.
2. Click on the **LAN Driver** button to continue.

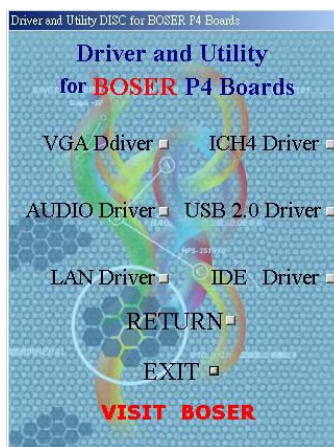

3. Click on the **Windows 9x** button to continue.

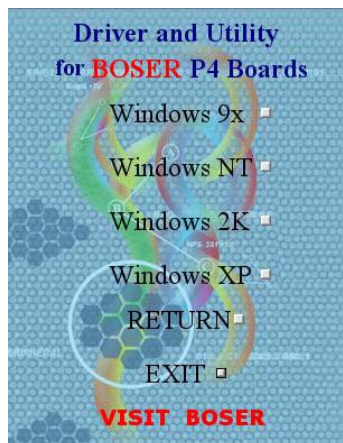

4. When the dialog box below appears, make sure you close all other Windows applications then click on the **Next >** button to proceed.

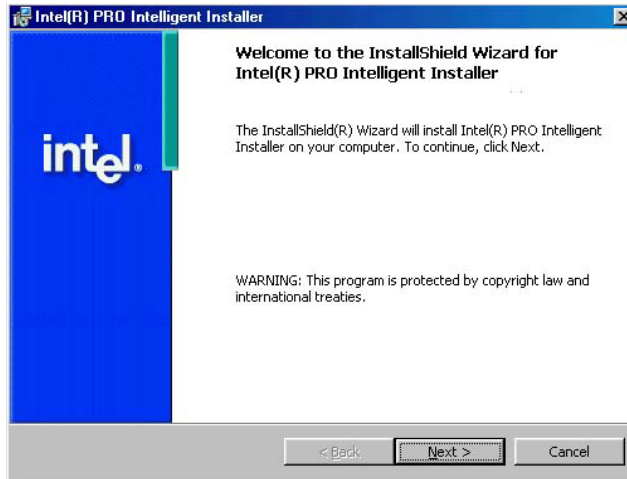

5. The Intel OEM Software License Agreement dialog box then appears on the screen. Choose **Accept** to proceed.



6. The Setup Type dialog box then appears on the screen. Choose **Typical** to proceed.

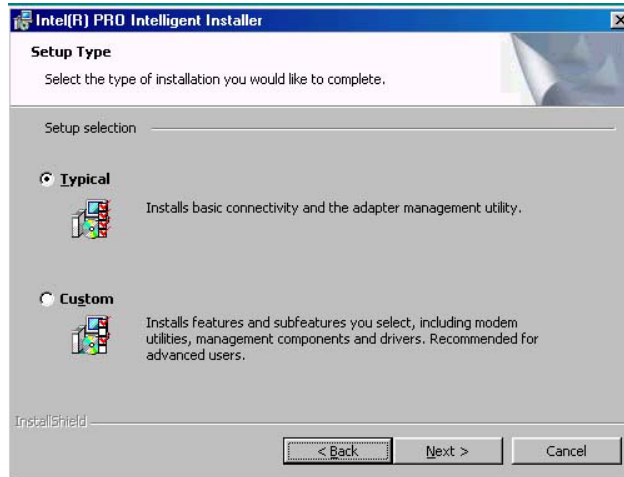

7. When the dialog box below appears, make sure you close all other Windows applications then click on the **Install** button to proceed.

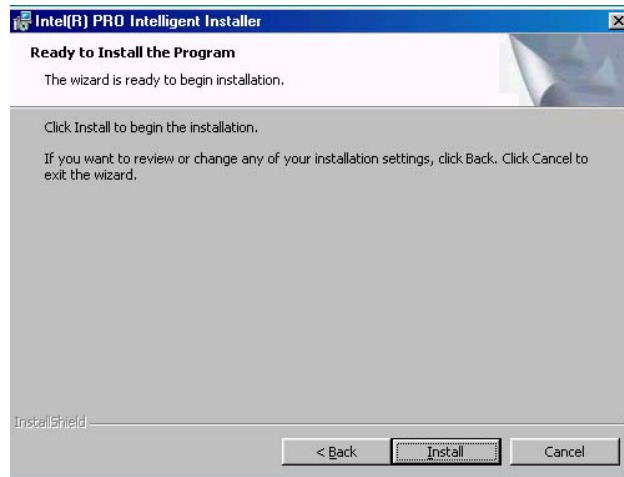

- When the dialog box below appears, it means your driver is install completed. Click **Finish** button to proceed.

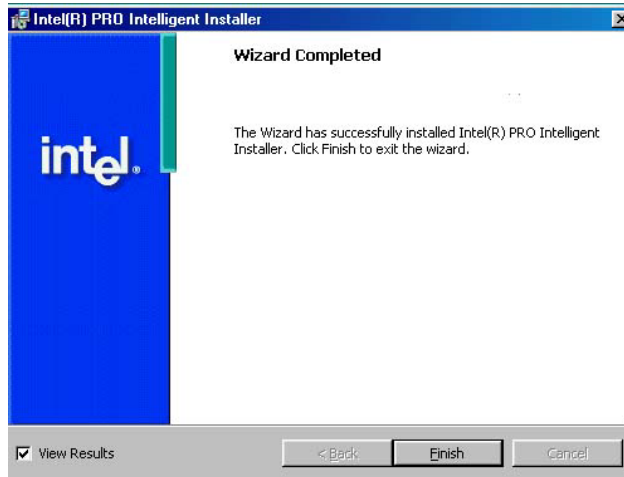

- Once the setup program finishes copying files into your system, it will prompt you to restart the computer. Tick on the **Yes** to reboot. Only after your computer boots will the new settings take effect.

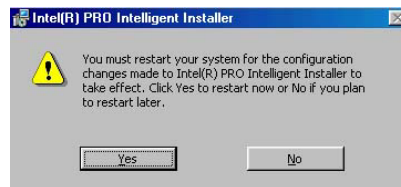

6.3.2 Win NT

NOTE: Please make sure you have already install **Service Pack 6.0**.

- The system automatically detects the absence of Windows NT Networking. Click on the **Yes** button to start installation.

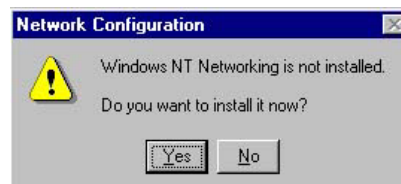

2. Tick on the **Wired to Network** once the following screen appears. Click on the Next to proceed.

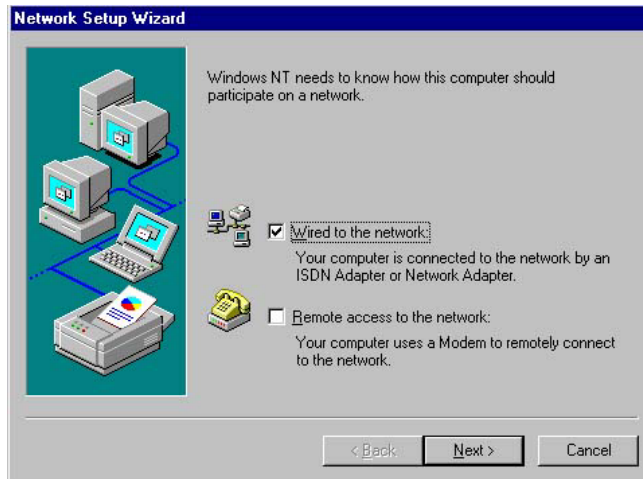

3. Click on the **Start Search** button for the program to locate the Network Adapter.

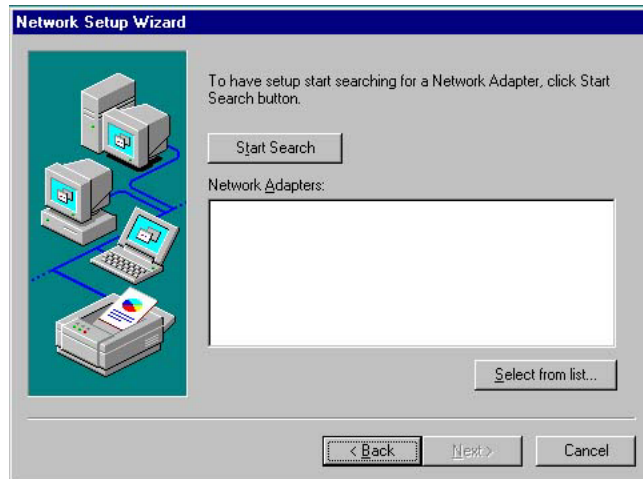

- Once setup finishes the search, it will list a number of adapters for you to choose from. Press on the **Have Disk** button to assign the driver path location.

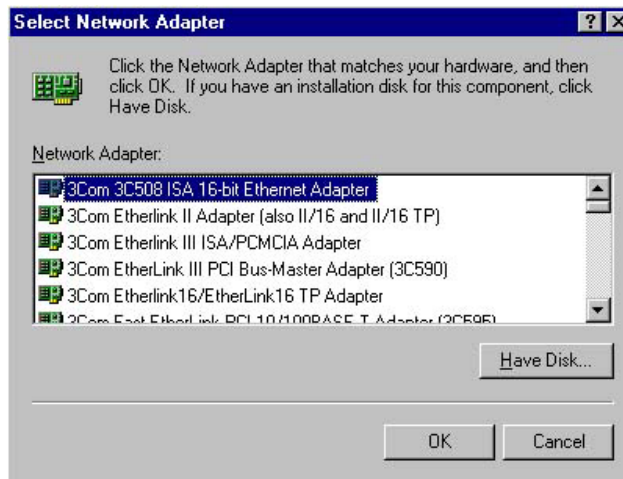

- Setup now asks you for the location of the driver. When you have entered the new driver path, press on the **OK** button to continue.

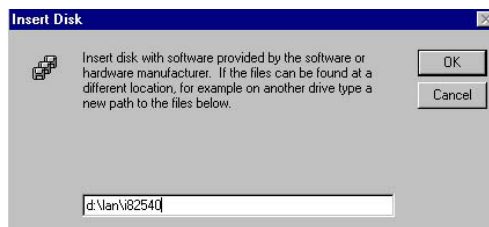

- When Setup finds the information it needs about the new driver, it will display the device it found on the following screen. Please choose "**Intel(R) PRO/100 Family Adapter**". Press on the **OK** button to accept and proceed.



- Setup then returns to Network Setup Wizard screen and displays your new Network Adapter. Click on **Next** to continue.

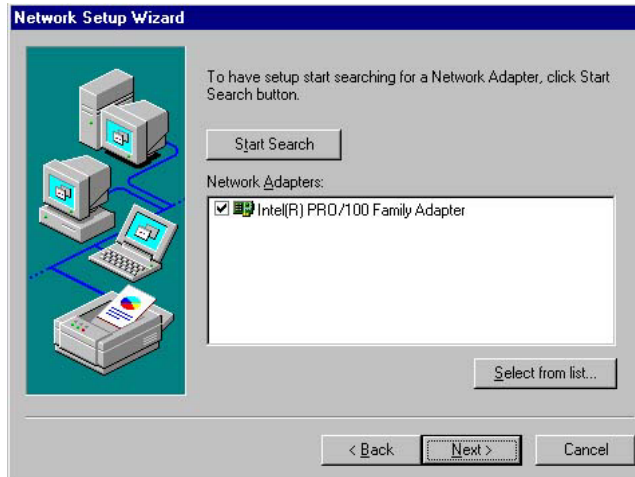

- The Network Setup Wizard then allows you to set the Network Protocols on your network. Select the appropriate protocol and then click on Next to continue.

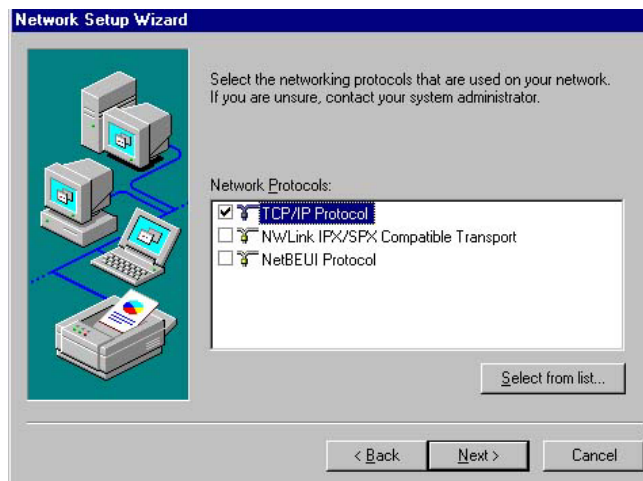

9. Before Setup starts installing the components found and the settings you made, it will give you the option to proceed or go back for changes from the following screen. Click on the **Next** button once you are sure of your devices.

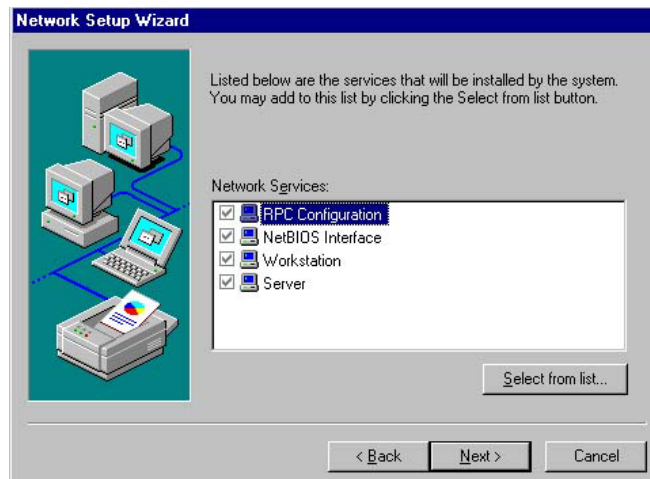

10. Windows NT Setup will then need to copy files necessary to update the system information. Specify the path then press **Continue**.

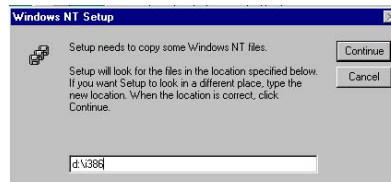

11. When Setup asks if you wish to change the TCP/IP settings of your system, select the appropriately. The default choice is **No**.

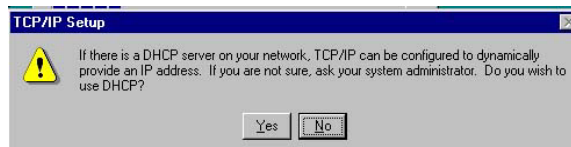

12. Setup then starts the Networking installation and copies the files.

13. When the screen below appears, click on **Next** to continue.

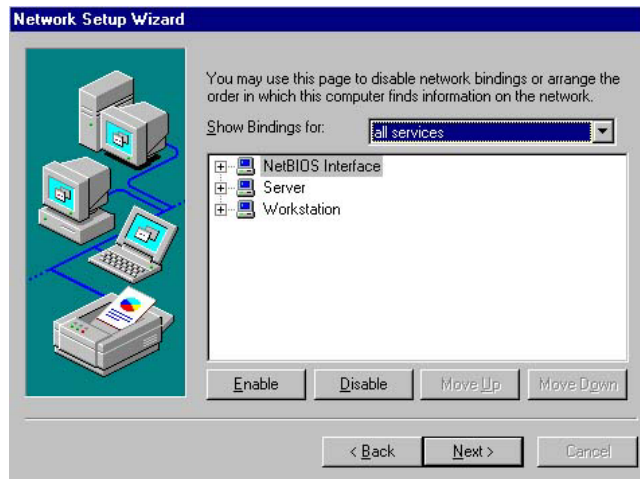

14. Setup then prompts you that it is ready to start the network. You may complete the installation thereafter. Click on **Next** to continue.

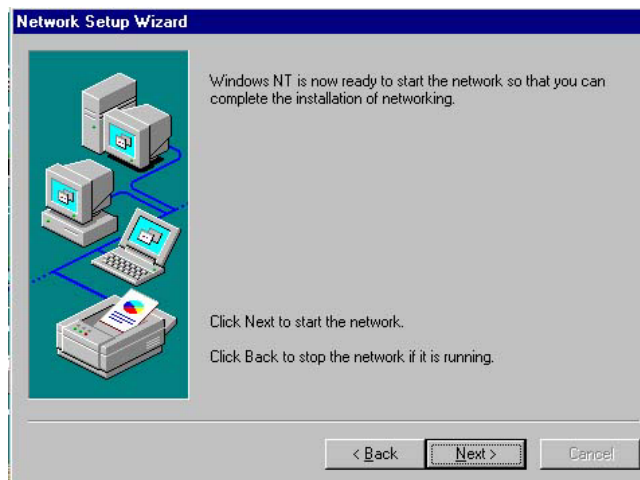

15. Assign the workgroup or domain setting of your computer. Click on Next to continue.

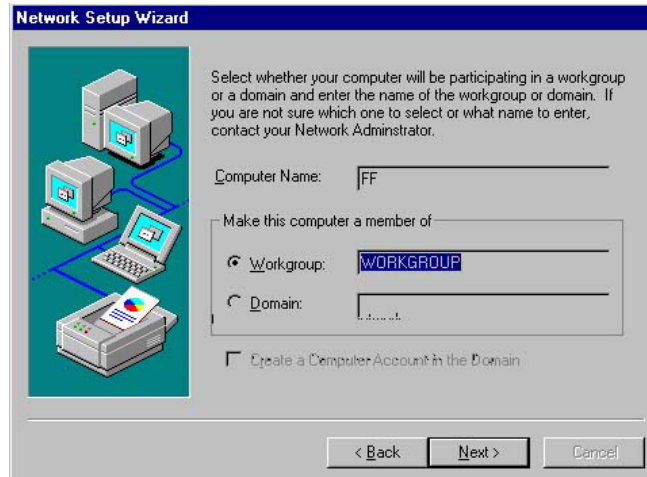

16. Click on the **Yes** button to restart your computer. The LAN driver installation for WIN NT4.0 is now complete.

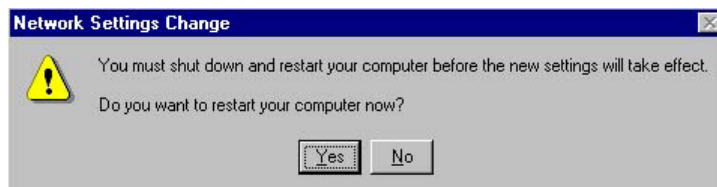

6.4 Audio Driver Installation

1. Insert Utility CD Disk to your CD ROM drive. The main menu will pop up as shown below. Select on the **HS-4701** button to launch the installation program.

2. Click on the **AUDIO Driver** button to continue.

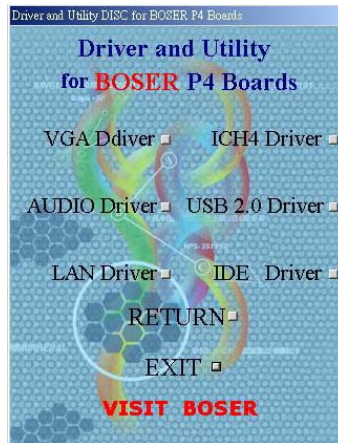

3. When the dialog box below appears, make sure you close all other Windows applications then click on the **Next >** button to proceed.



4. Once the InstallShield Wizard completes the operation and update of your AC97 driver, it will ask you to remove disks from their drives, and prompt you to restart your system. Tick on the Yes, I want to restart my computer now. Afterwards, click on the **Finish** button to complete the installation process. The system changes you made will take effect after the system restarts.



This page intentionally left blank.

Appendix A

Power Supply

This is the specification of Model FSP180-50PLA; AC-line powered switching power supply with active PFC (Power Factor Correction) circuit, meet EN61000-3-2 and with Full Range Input features.

The specification below is intended to describe as detailedly as possible the functions and performance of the subject power supply. Any comment or additional requirements to this specification from our customers will be highly appreciated and treated as a new target for us to approach.

A.1 Safety Approvals

The subject power supply will meet the EMI requirements and obtain main safety approvals as following:

A.1.1 EMI Regulatory

- FCC Part 15 Subpart J, Class 'B' 115 Vac operation
- CISPR 22 Class 'b' 230 Vac operation

A.1.2 Safety

- NEMKO EN 60950
- TUV EN60950 OR VDE EN60950
- CSA 22.2 NO. 234 LEVEL 3
- IEC 950
- UL 1950
- CE

A.2 Physical Requirements

A.2.1 Mechanical Specifications

The mechanical drawing of the subject power supply, which indicate the form factor, location of the mounting holes, location, the length of the connectors, and other physical specifications of the subject power supply. Please refer to the attachment drawing.

A.2.2 Connector Specifications

The power supply connectors are:

AC Inlet: Standard inlet socket 10A/250V, UL/CSA/VED approved

- **P1:** The equivalent of MOLEX 39-01-2200, 20-pin connector
- **PA, PC, PD:** The equivalent of AMP 1-480424-0, 4-pin connector
- **PB:** The equivalent of AMP 171822-4, 4-pin connector
- **PE:** The equivalent of MOLEX 39-01-2040, 4-pin connector

A.2.3 Connector PIN Designations

	P1		PA, PC, PD		PB		PE	
PIN1	+3.3V	Orange	+12V	Yellow	+12V	Yellow	COM	Black
PIN2	+3.3V	Orange	COM	Black	COM	Black	COM	Black
PIN3	COM	Black	COM	Black	COM	Black	+12V	Yellow
PIN4	+5V	Red	+5V	Red	+5V	Red	+12V	Yellow
PIN5	COM	Black						
PIN6	+5V	Red						
PIN7	COM	Black						
PIN8	PW-OK	Gray						
PIN9	+5Vsb	Purple						
PIN10	+12V	Yellow						
PIN11	+3.3V	Orange						
	+3.3VS	Brown						
PIN12	-12V	Blue						
PIN13	COM	Black						
PIN14	PS-ON	Green						
PIN15	COM	Black						
PIN16	COM	Black						
PIN17	COM	Black						
PIN18	N/C	N/C						
PIN19	+5V	Red						
PIN20	+5V	Red						

A.3 Electrical Requirements

The subject power supply will meet all electrical specifications below, over the full operation temperature range and dynamic load regulation.

● Output Rating

Output	Nominal	Regulation	Ripple/Noise	Min.	Max.
1	+3.3V	+/-5%	50mV	0.3A	16.8A
2	+5V	+/-5%	50mV	0.3A	12.0A
3	+12V	+/-5%	120mV	1.5A	10.0A
4	-12V	+/-10%	120mV	0.0A	0.8A
5	+5VSB	+/-5%	50mV	0.0A	2.0A

NOTE: -12V, +3.3V, +5V, +12V will have the regulation to +/-10% when all load take off.

The +3.3V and +5V total output shall not exceed 61 watts. The +3.3V, +5V and +12V total output shall not exceed 165 watts and the total output for this subject power supply is 180 watts. Ripple and noise measurements shall be made under all specified load conditions through a single pole low pass filter with 20MHz cutoff frequency. Outputs shall bypassed at the connector with a 0.1uF ceramic disk capacitor and a 10uF electrolytic capacitor to simulate system loading.

● Load Capacity Specifications

Load	STM	+3.3V	+5V	+12V	-12v
All Max	HHHH	4.5A	9.0A	9.0A	0.8A
+5V Max other Min	LHLL	0.3A	12.0A	1.5A	0.0A
+3.3V Max other Min	HLLL	16.8A	0.3A	1.5A	0.0A
+12V max other Min	LLHL	0.3A	0.3A	10.0A	0.0A
All Min	LLLL	0.3A	0.3A	1.5A	0.0A

● Hold Up Timer (@Full Load)

- 115V/60Hz: 17mSec. Minimum.
- 230V/50Hz: 17mSec. Minimum.

● Output Rise Time (10% to 90% of Final Output Value, @Full Load)

- 115V-rms or 230V-rms; +5Vdc: 20mx Max.

- **Over Voltage Protection**

- +5V_{dc} output: +5.7V_{dc} min.; +6.5V_{dc} max.
- +12V_{dc} output: +13.3V_{dc} min.; +15.6V_{dc} max.
- +3.3V_{dc} output: +3.7V_{dc} min.; +4.5V_{dc} max.

- **Short Circuit Protection**

Output short circuit is defined to be a short circuit load of less than 0.1 ohm.

In the event of an output short circuit condition on +3.3V, +5V or +12V output, the power supply will shutdown and latch off. The power supply shall return to normal operation after the short circuit has been removed and the power switch has been turned off for no more than 2 seconds.

In the event of an output short circuit condition – 12V output, the power supply will not be latch off. The power supply shall return to normal operation as soon as the short circuit has been removed and the power switch has been turned off for no more than 2 seconds.

- **Overload Protection**

Overload currents defined as a 10 amp/sec fault current ramp starting from full load, applied to the +3.3V, +5V output, shall not cause that output to exceed 32 amps before the output voltage drops below 0.5 volts and is latched off. The +12V output shall not exceed 20 amps under the same ramp conditions starting at full load before it is latched off.

- **Power Good Signal**

The power good signal is a TTL compatible signal for the purpose of initiating an orderly start-up procedure under normal input operating conditions. This signal is asserted (low) until +5V_{dc} has reached 4.75 volts during power up. Characteristics:

- TTL signal asserted (low state): less than 0.5V while sinking 10mA.
- TTL signal asserted (high state): greater than 4.75V while sourcing 500uA.
- High state output impedance: less or equal to 1Kohm from output to common.

Power Good @ 115/230V, Full Load	100~500mSec.
Power Fail @ 115/230V, Full Load	1mSec. Minimum

- **Output Transient Load Response**

+5V and +12V must be within specification for a step change in current as specified below. The outputs will be tested one section at a time with all other sections at maximum load. The test transition will be from IA to IB and IB to IA.

	+5V vdc	+12V vdc	+3.3V vdc
IA	12.0 amps	9.0 amps	16.8 amps
IB	8.4 amps	7.0 amps	13.0 amps
Volts Variation	+5V +/-5%	+12V +/-5%	+3.3V +/-5%
Setting Time	10ms max.	10ms max.	10ms max.
Transient Load Slew Rate Is	0.5A/uS	0.1A/uS	0.1A/uS

NOTE: +5Vsb: 0.5A; -12V: 0.1A

- **AC Input Line Requirements**

Parameter	Min.	Nom.⁽¹⁾	Max.	Unit
V_{in} (115VAC)	90	115	135	VAC _{rms}
V_{in} (230VAC)	180	230	265	VAC _{rms}
V_{in} Frequency	47	----	63	HZ

NOTE: Nominal voltages for test purposes are considered to be within +/-1.0V of nominal.

- **Inrush Current (Cold start – 25 deg. C)**

115V	50Amps-peak
230V	80Amps-peak

- **Input Line Current**

115V	4.0 Amps – rms max.
230V	2.0 Amps – rms max.

- **Efficiency**

115VAC @ Full Load	68% min.
230VAC @ Full Load	68% min.

- **PS_ON**

	Min.	Max.
V_{IL}, Input Low Voltage	0.0V	0.8V
V_{IL}, Input Low Current (V_{in}=0.4V)		-1.6mA
V_{IH}, Input High Voltage (I_{in}=-200uA)	2.0V	
V_{IH}, Open Circuit, I_{in} =0		5.25V

A.4 Environmental Requirements

The power supply will be compliant with each item in this specification for the following Environmental conditions.

- **Temperature Range**

Operating	0 to +50 deg. C
Storage	-20 to +80 deg. C

- **Humidity**

Operating	5~95% RH, Non-condensing
Storage	5~95% RH, Non-condensing

- **Vibration**

The subject power supplies will withstand the following imposed conditions without experiencing non-recoverable failure or deviation from specified output characteristics.

Vibration Operating – Sine wave excited, 0.5G maximum acceleration, 10~250Hz swept at one octave/min. Fifteen minute dwell at all resonant points, where resonance is defined as those exciting frequencies at which the device under test experiences excursions two times large than non-resonant excursions.

Plane of vibration to be along three mutually perpendicular axes.

- **Shock**

The subject power supplies will withstand the following imposed conditions without experiencing non-recoverable failure or deviation from specified output characteristics.

- **Storage:** -40G, 11mSec. Half-sine wave pulse in both directions on three mutually perpendicular axes.
- **Operating:** -10G, 11mSec. Half-sine wave pulse in both directions on three mutually perpendicular axes.

- **Cooling Specifications**

The PS is cooled by a self-contained, 40mm, 12VDC

A.5 Safety

In addition to the UL CSA and NEMKO safety requirements, the leakage current from AC to safety ground will not exceed 1mA-rms at 240Vac, 50Hz

A.6 Electromagnetic Compatibility

- **Line Conducted EMI**

The subject power supplies will meet FCC and VFG class B requirements.

- **Radiated EMI**

The subject power supplies will meet FCC and CISPR 22 requirements.

A.7 Labeling

Label marking will be permanent, legible and complied with all agency requirements.

- **Model Number Label**

Labels will be affixed to the sides of the power supply showing the following:

- Manufacturer's name and logo
- Model no., serial no., revision level, location of manufacturer
- The total power output and the maximum load for each output
- AC input rating

- **DC Output Identification**

Each output connector will be labeled.

A.8 Reliability

- **MTBF**

The power supply have a minimum predicted MTBF of 100,000 hours of continuous operation at 25 deg. C, maximum-output load, and nominal AC input voltage.

A.9 Safety Requirements

- Safety

The subject power designed to meet the following safety regulations.

- NEMKO
- TUV or VDE
- UL 1950
- CSA 22.2 LEVEL 3
- CE

A.10 Dimensions

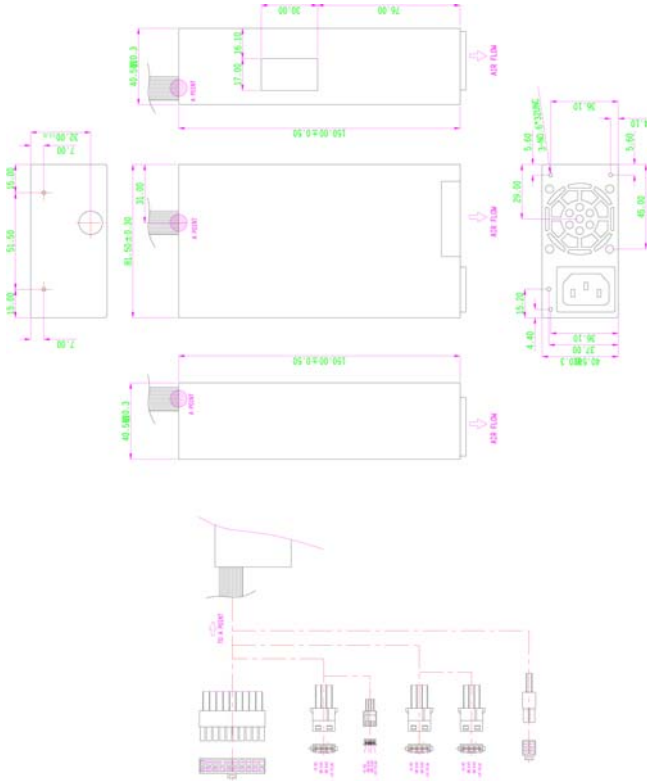

Appendix B

Capture card

BS-667 is an acquisition board designed without compromise for security and video surveillance applications. It constitutes an ideal device for PC based multiple-channel digital video recorder.

This 32-bit 33MHz PCI Bus frame grabber captures simultaneously four video analog streams in real-time. It accepts standard composite color (PAL, NTSC) or monochrome video formats (CCIR, EIA).

The resolution is programmable including the square-pixel resolution (640 * 480 or 768 * 576) and the broadcast resolution. Before transfer into the PC memory, the image can be scaled down using a selectable ratio.

Arbitrary cropping to a region of interest is possible. BS-667 generates bitmaps in all popular color formats such as RGB, YUV, planar or packed.

System integrators benefit from a watchdog for fault-tolerant applications and from easy-to-use standard connectors.

I/O connectivity is built-in. Protection circuit design for software design security issue.

B.1 Features

- Four channels full-frame real-time acquisition from four video streams
- 32-bit PCI, Rev2.2, 33MHz
- Channel expand up to 8 channels
- Applicable signal type: color-PAL/NTSC, monochrome-CCIR/EIA
- Onboard TTL I/O lines
- Built-in watchdog timer
- Protection circuit for security issue

B.2 Frame Rate

30 full-frame images acquired per second for each channel.

B.3 Image Acquisition

- **Color Image:** The color video format is compatible with the following composite video input formats
NTSC-M, NTSC-Japan, PCL-B, PAL-D, PAD-G, PAL-H, PAL-I, PAM-M, PAL-N and SECAM
- **Monochrome Images:** The monochrome video acquisition is compatible with CCIR and EIA (RS-170)
- **Optional Scaling:** The BS-667 acquire images or portions of images with optional scaling
 - Acquisition of a programmable area of interest
 - Scaling of the image (down to 1:16)
 - Adjustment of hue (for NTSC signals), contrast (0 to 200%), brightness and saturation (0 to 200% for U and V signals)
 - Automatic chrominance gain control

B.4 I/O Lines

The BS-667 is fitted with TTL compatible I/O lines protected against overloads and electrostatic discharges.

Every line may be configured as an input or output. They can be used to trigger the acquisition or report alarms signal.

B.5 Watchdog Timer

A hardware watchdog timer is available on BS-667. The watchdog timer is able to monitor the PC application operation and will automatically restart the PC after a programmable inactivity time-out. This ensures a reliable operation of remote systems.

B.6 Applications

- **PC Based Surveillance System**
- **Digital Video Recorder (DVR)**
- **Factory Monitoring System**
- **Industrial Inspection System**

B.7 Software Supporting WDM Driver

The drivers support VC++/VB programming on Windows NT/98/2000 platform with DLL..