



Frontier Electronics Corp.

667 E. COCHRAN STREET, SIMI VALLEY, CA 93065

TEL: (805) 522-9998 FAX: (805) 522-9989

E-mail: frontiersales@frontierusa.com

Web: <http://www.frontierusa.com>

10A ULTRA FAST RECOVERY RECTIFIER

UFF100-005 THRU UFF100-06

CASE : ITO-220AC(UFF100-XX) FULLY INSULATED PACKAGE

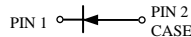
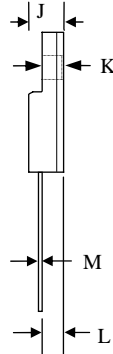
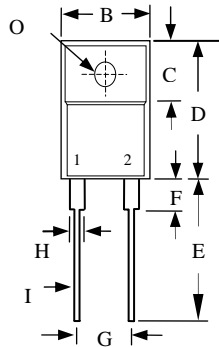

	MILLIMETERS	
	MIN	MAX
B	9.72	10.27
C	6.30	6.90
D	14.50	15.50
E	13.00	13.80
F	-	4.1
G	4.95	5.20
H	-	1.52
I	-	0.9
J	-	4.8
K	-	3.1
L	2.5	2.9
M	-	0.8
O	-	Ø 3.4

FEATURES

- ULTRA FAST RECOVERY TIME
- LOW FORWARD VOLTAGE
- LOW THERMAL RESISTANCE
- HIGH CURRENT CAPABILITY
- HIGH VOLTAGE
- GLASS PASSIVATED CHIP JUNCTION

MECHANICAL DATA

- CASE: TRANSFER MOLDED
- TERMINAL: SOLDERABLE PER MIL-STD-202, METHOD 208
- POLARITY: AS MARKED
- EPOXY: UL94V-0 FLAME RETARDANT MOLDING COMPOUND
- WEIGHT 1.81 GRAMS

MAXIMUM RATINGS AND ELECTRICAL CHARACTERISTICS RATINGS AT 25°C AMBIENT TEMPERATURE UNLESS OTHERWISE SPECIFIED SINGLE PHASE, HALF WAVE, 60 HZ, RESISTIVE OR INDUCTIVE LOAD. FOR CAPACITIVE LOAD, DERATE CURRENT BY 20%

RATINGS	SYMBOL	UFF100-005	UFF100-01	UFF100-02	UFF100-03	UFF100-04	UFF100-05	UFF100-06	UNITS
MAXIMUM RECURRENT PEAK REVERSE VOLTAGE	V_{RRM}	50	100	200	300	400	500	600	V
MAXIMUM RMS VOLTAGE	V_{RMS}	35	70	140	210	280	350	420	V
MAXIMUM DC BLOCKING VOLTAGE	V_{DC}	50	100	200	300	400	500	600	V
MAXIMUM AVERAGE FORWARD RECTIFIED CURRENT SEE FIG.1	I_O	10.0							A
PEAK FORWARD SURGE CURRENT, 8.3ms SINGLE HALF SINE-WAVE SUPERIMPOSED ON RATED LOAD	I_{FSM}	125							A
TYPICAL JUNCTION CAPACITANCE (NOTE 1)	C_J	65							PF
TYPICAL THERMAL RESISTANCE (NOTE 2)	$R_{\theta jc}$	2.2							°C/W
STORAGE TEMPERATURE RANGE	T_{STG}	- 55 TO + 150							°C
OPERATING TEMPERATURE RANGE	T_{OP}	- 55 TO + 150							°C

ELECTRICAL CHARACTERISTICS ($A_T T_A = -25^\circ C$ UNLESS OTHERWISE NOTED)

CHARACTERISTICS	SYMBOL	UFF100-005	UFF100-01	UFF100-02	UFF100-03	UFF100-04	UFF100-05	UFF100-06	UNITS
MAXIMUM FORWARD VOLTAGE AT I_O PER LEG	V_F	1.10			1.30		1.50		V
MAXIMUM DC REVERSE CURRENT AT $T_A = -25^\circ C$	I_R	10							μA
MAXIMUM DC REVERSE CURRENT AT $T_A = 100^\circ C$	I_R	100							μA
MAXIMUM REVERSE RECOVERY TIME (NOTE 3)	T_{RR}	35			50				nS

- NOTES: 1. MEASURED AT 1 MHZ AND APPLIED REVERSE VOLTAGE OF 4.0 VOLTS
 2. THERMAL RESISTANCE JUNCTION TO CASE PER LEG MOUNTED ON HEAT SINK
 3. REVERSE RECOVERY TEST CONDITIONS: $I_F = 0.5A$, $I_R = 1.0A$, $I_{RR} = 0.25A$

RATINGS AND CHARACTERISTIC CURVE UFF100-005 THRU UFF100-06

FIG. 1 -TEST CIRCUIT DIAGRAM AND REVERSE RECOVERY TIME CHARACTERISTIC

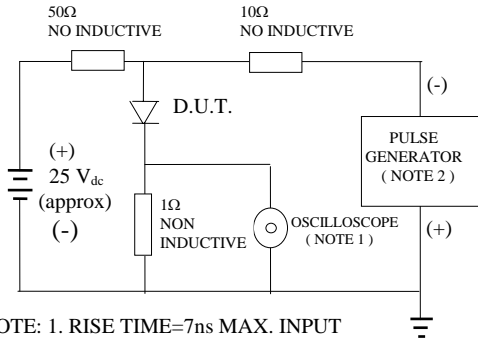

NOTE: 1. RISE TIME=7ns MAX. INPUT IMPEDANCE=1 MOhms 22PF
 2. RISE TIME =10 ns MAX. SOURCE IMPEDANCE=50 OHMS

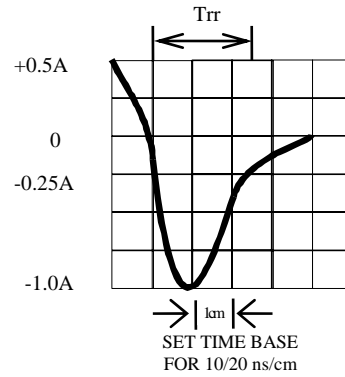

FIG. 2 -MAXIMUM FORWARD CURRENT DERATING CURVE

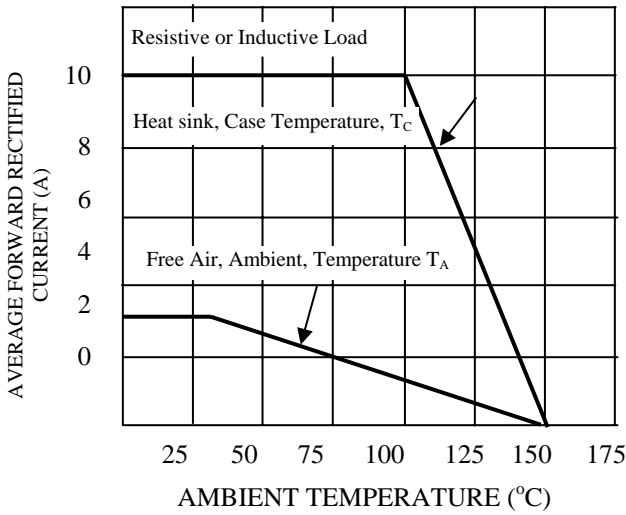

FIG. 3 -TYPICAL INSTANTANEOUS FORWARD CHARACTERISTICS

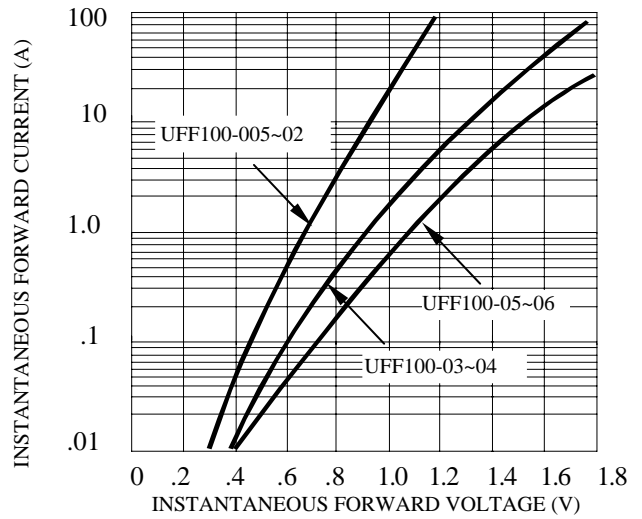

FIG. 4 -TYPICAL REVERSE CHARACTERISTICS

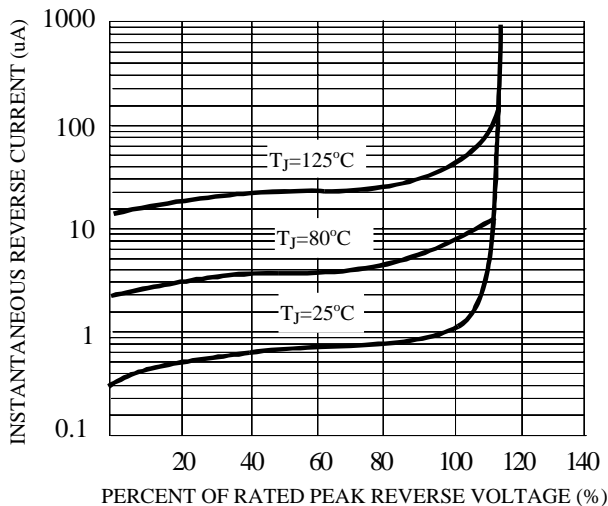

FIG. 5 -TYPICAL JUNCTION CAPACITANCE

