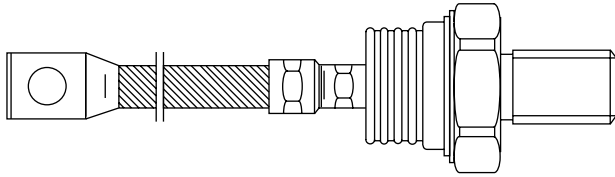

## Standard Recovery Diodes (Stud Version), 600 A

**B-8**
**FEATURES**

- Wide current range
- High voltage ratings up to 3200 V
- High surge current capabilities
- Stud cathode and stud anode version
- Standard JEDEC types
- Compression bonded encapsulations
- RoHS compliant
- Lead (Pb)-free
- Designed and qualified for industrial level

**RoHS  
COMPLIANT**
**PRODUCT SUMMARY**

$I_{F(AV)}$	600 A
-------------	-------

**TYPICAL APPLICATIONS**

- Converters
- Power supplies
- Machine tool controls
- High power drives
- Medium traction applications

**MAJOR RATINGS AND CHARACTERISTICS**

PARAMETER	TEST CONDITIONS	SD600N/R		UNITS
		04 to 20	22 to 32	
$I_{F(AV)}$		600		A
	$T_C$	92	54	°C
$I_{F(RMS)}$		940		A
$I_{FSM}$	50 Hz	13 000	10 500	
	60 Hz	13 600	11 000	
$I^2t$	50 Hz	845	551	kA <sup>2</sup> s
	60 Hz	772	503	
$V_{RRM}$	Range	400 to 2000	2200 to 3200	V
$T_J$		- 40 to 180	- 40 to 150	°C

**ELECTRICAL SPECIFICATIONS**
**VOLTAGE RATINGS**

TYPE NUMBER	VOLTAGE CODE	$V_{RRM}$ , MAXIMUM REPETITIVE PEAK REVERSE VOLTAGE V	$V_{RSM}$ , MAXIMUM NON-REPETITIVE PEAK REVERSE VOLTAGE V	$I_{RRM}$ MAXIMUM AT $T_J = T_J$ MAXIMUM mA
SD600N/R	04	400	500	35
	08	800	900	
	12	1200	1300	
	16	1600	1700	
	20	2000	2100	
	22	2200	2300	
	28	2800	2900	
	32	3200	3300	

FORWARD CONDUCTION							
PARAMETER	SYMBOL	TEST CONDITIONS		SD600N/R		UNITS	
				04 to 20	22 to 32		
Maximum average forward current at case temperature	$I_{F(AV)}$	180° conduction, half sine wave		600		A	
				92	54	°C	
				570	375	A	
				100		°C	
Maximum RMS forward current	$I_{F(RMS)}$	DC at $T_C = 75\text{ °C}$ (04 to 20), $T_C = 36\text{ °C}$ (25 to 32)		940			
Maximum peak, one-cycle forward, non-repetitive surge current	$I_{FSM}$	t = 10 ms	No voltage reapplied	Sinusoidal half wave, initial $T_J = T_J$ maximum	13 000	10 500	A
		t = 8.3 ms			13 600	11 000	
		t = 10 ms	100 % $V_{RRM}$ reapplied		10 900	8830	
		t = 8.3 ms			11 450	9250	
Maximum $I^2t$ for fusing	$I^2t$	t = 10 ms	No voltage reapplied		845	551	kA <sup>2</sup> s
		t = 8.3 ms			772	503	
		t = 10 ms	100 % $V_{RRM}$ reapplied		598	390	
		t = 8.3 ms			546	356	
Maximum $I^2\sqrt{t}$ for fusing	$I^2\sqrt{t}$	t = 0.1 to 10 ms, no voltage reapplied		8450	5510	kA <sup>2</sup> √s	
Low level value of threshold voltage	$V_{F(TO)1}$	(16.7 % $\times \pi \times I_{F(AV)} < I < \pi \times I_{F(AV)}$ ), $T_J = T_J$ maximum		0.78	0.84	V	
High level value of threshold voltage	$V_{F(TO)2}$	(1 $> \pi \times I_{F(AV)}$ ), $T_J = T_J$ maximum		0.87	0.88		
Low level value of forward slope resistance	$r_{f1}$	(16.7 % $\times \pi \times I_{F(AV)} < I < \pi \times I_{F(AV)}$ ), $T_J = T_J$ maximum		0.35	0.40	mΩ	
High level value of forward slope resistance	$r_{f2}$	(1 $> \pi \times I_{F(AV)}$ ), $T_J = T_J$ maximum		0.31	0.38		
Maximum forward voltage drop	$V_{FM}$	$I_{pk} = 1500\text{ A}$ , $T_J = T_J$ maximum, $t_p = 10\text{ ms}$ sinusoidal wave		1.31	1.44	V	

THERMAL AND MECHANICAL SPECIFICATIONS						
PARAMETER	SYMBOL	TEST CONDITIONS		SD600N/R		UNITS
				04 to 20	22 to 32	
Maximum junction operating temperature range	$T_J$			- 40 to 180	- 40 to 150	°C
Maximum storage temperature range	$T_{Stg}$			- 55 to 200		
Maximum thermal resistance, junction to case	$R_{thJC}$	DC operation		0.1		K/W
Maximum thermal resistance, case to heatsink	$R_{thCS}$	Mounting surface, smooth, flat and greased		0.04		
Maximum allowed mounting torque $\pm 10\%$		Not-lubricated threads		50		Nm
Approximate weight				454		g
Case style		See dimensions (link at the end of datasheet)		B-8		



$\Delta R_{thJC}$ CONDUCTION				
CONDUCTION ANGLE	SINUSOIDAL CONDUCTION	RECTANGULAR CONDUCTION	TEST CONDITIONS	UNITS
180°	0.012	0.008	T <sub>J</sub> = T <sub>J</sub> maximum	K/W
120°	0.014	0.014		
90°	0.017	0.019		
60°	0.025	0.026		
30°	0.042	0.042		

**Note**

- The table above shows the increment of thermal resistance  $R_{thJC}$  when devices operate at different conduction angles than DC

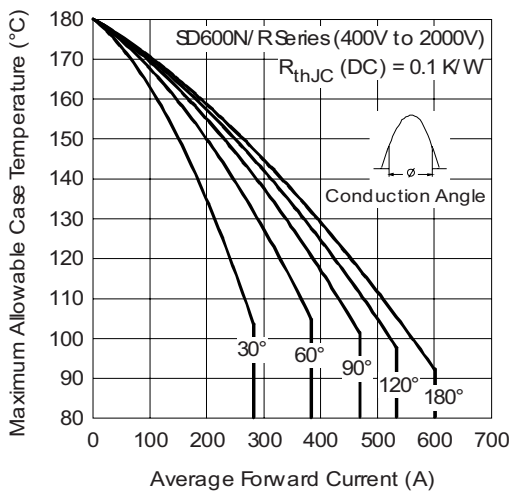

Fig. 1 - Current Ratings Characteristics

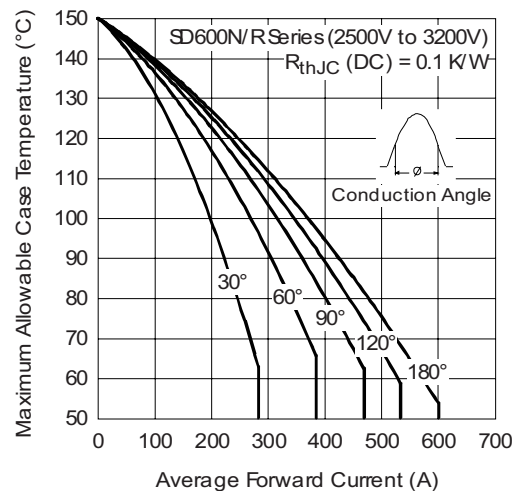

Fig. 3 - Current Ratings Characteristics

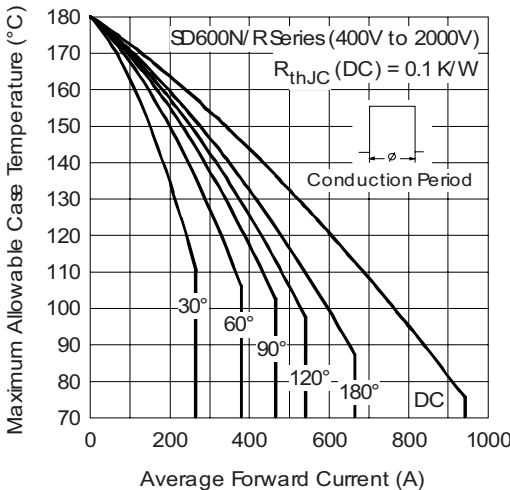

Fig. 2 - Current Ratings Characteristics

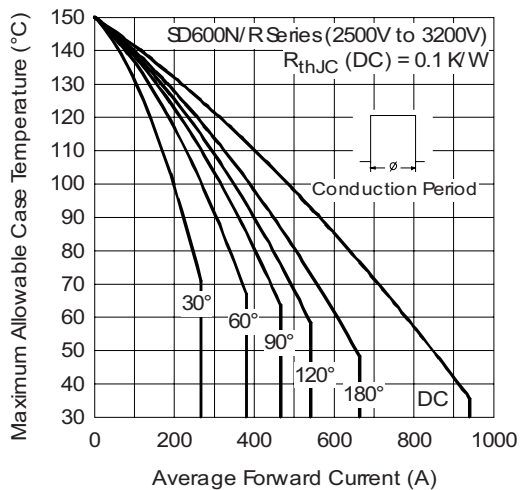
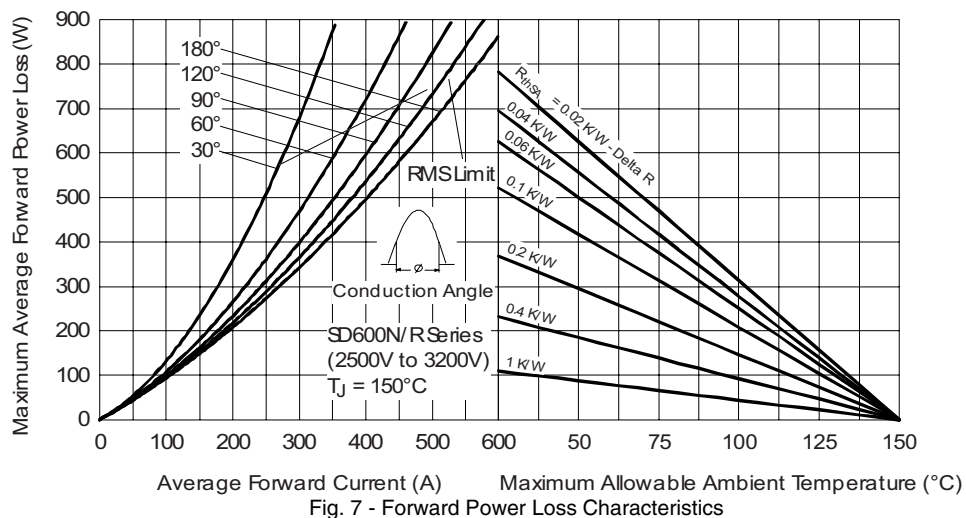
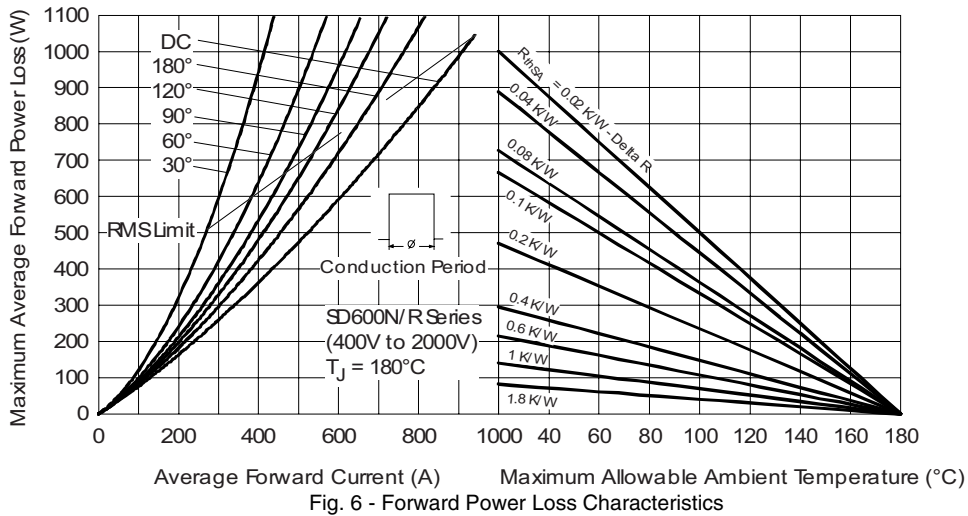
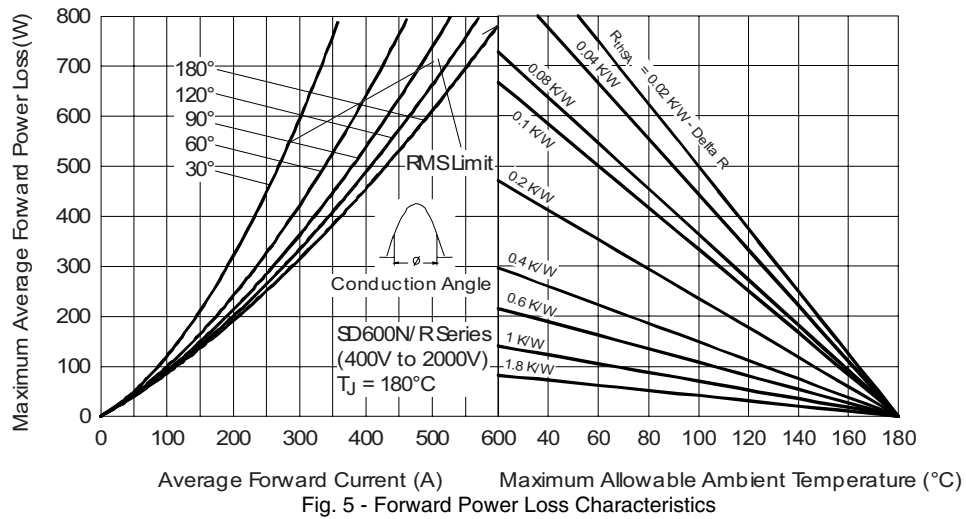

Fig. 4 - Current Ratings Characteristics

## Vishay High Power Products Standard Recovery Diodes (Stud Version), 600 A



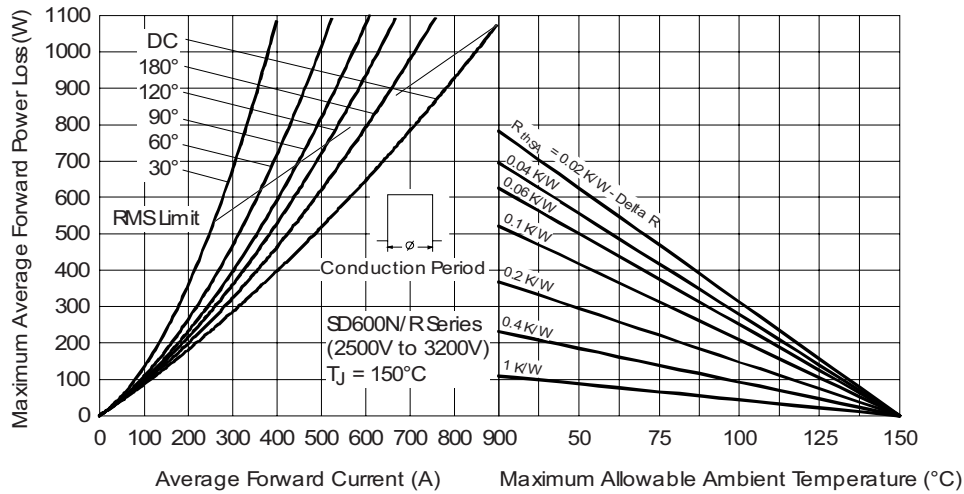

Fig. 8 - Forward Power Loss Characteristics

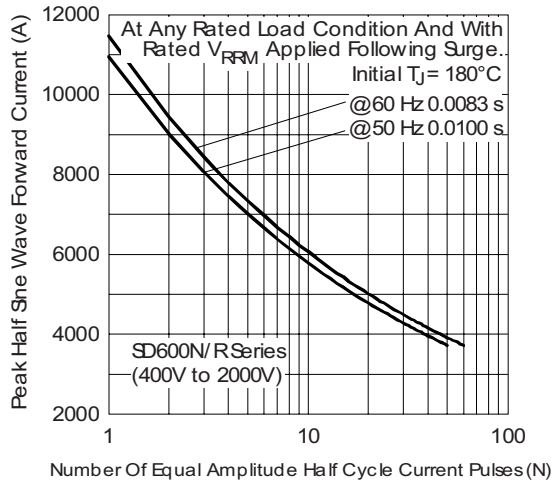

Fig. 9 - Maximum Non-Repetitive Surge Current

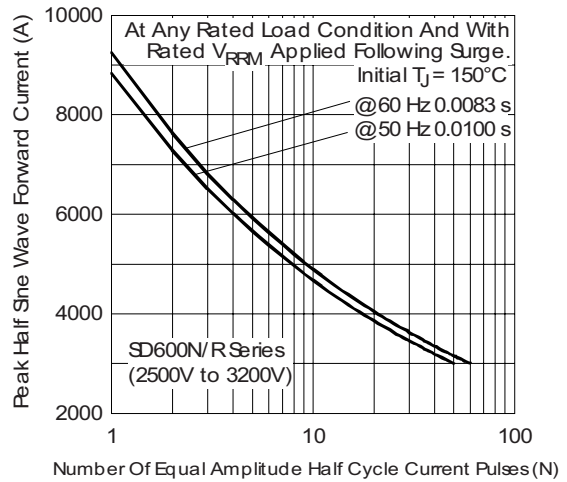

Fig. 11 - Maximum Non-Repetitive Surge Current

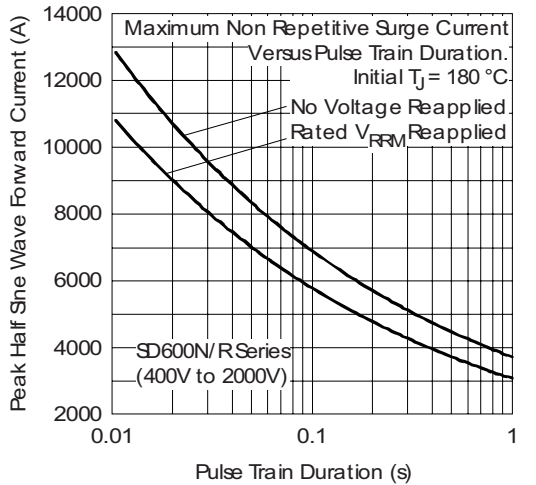

Fig. 10 - Maximum Non-Repetitive Surge Current

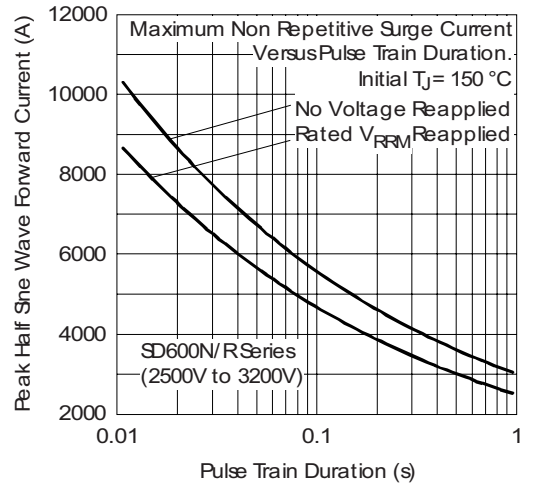

Fig. 12 - Maximum Non-Repetitive Surge Current

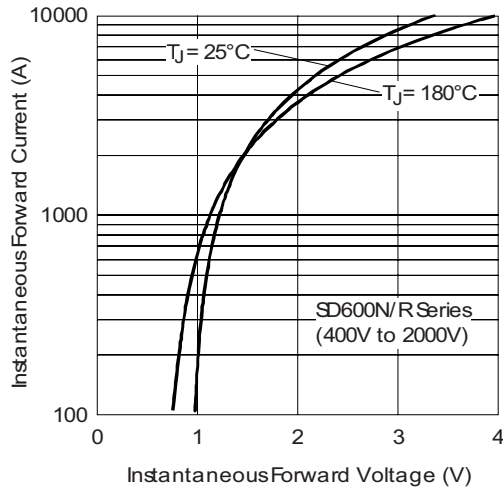

Fig. 13 - Forward Voltage Drop Characteristics

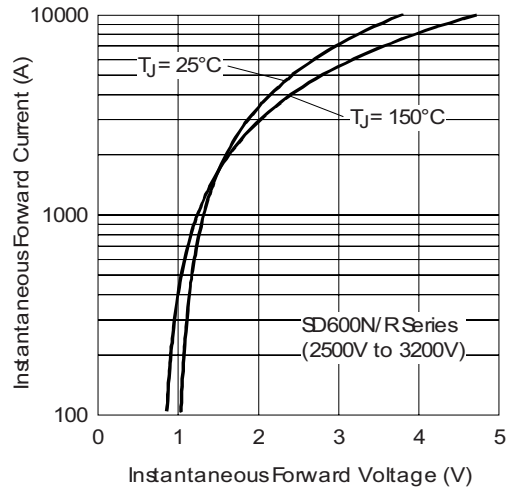

Fig. 14 - Forward Voltage Drop Characteristics

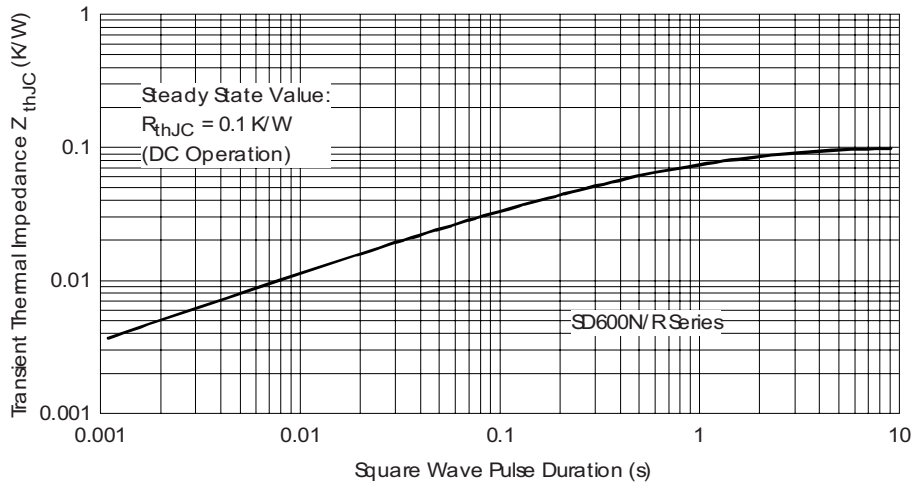

Fig. 15 - Thermal Impedance  $Z_{thJC}$  Characteristics



## ORDERING INFORMATION TABLE

Device code	<b>SD</b>	<b>60</b>	<b>0</b>	<b>N</b>	<b>32</b>	<b>P</b>	<b>C</b>
	①	②	③	④	⑤	⑥	⑦

- 1** - Diode
- 2** - Essential part number
- 3** - 0 = Standard recovery
- 4** -
  - N = Stud normal polarity (cathode to stud)
  - R = Stud reverse polarity (anode to stud)
- 5** - Voltage code x 100 =  $V_{RRM}$  (see Voltage Ratings table)
- 6** - P = Stud base B-8 3/4" 16UNF-2A
- 7** - C = Ceramic cap

For metric device M24 x 1.5 contact factory

LINKS TO RELATED DOCUMENTS	
Dimensions	<a href="http://www.vishay.com/doc?95303">http://www.vishay.com/doc?95303</a>

## B-8

**DIMENSIONS** in millimeters (inches)

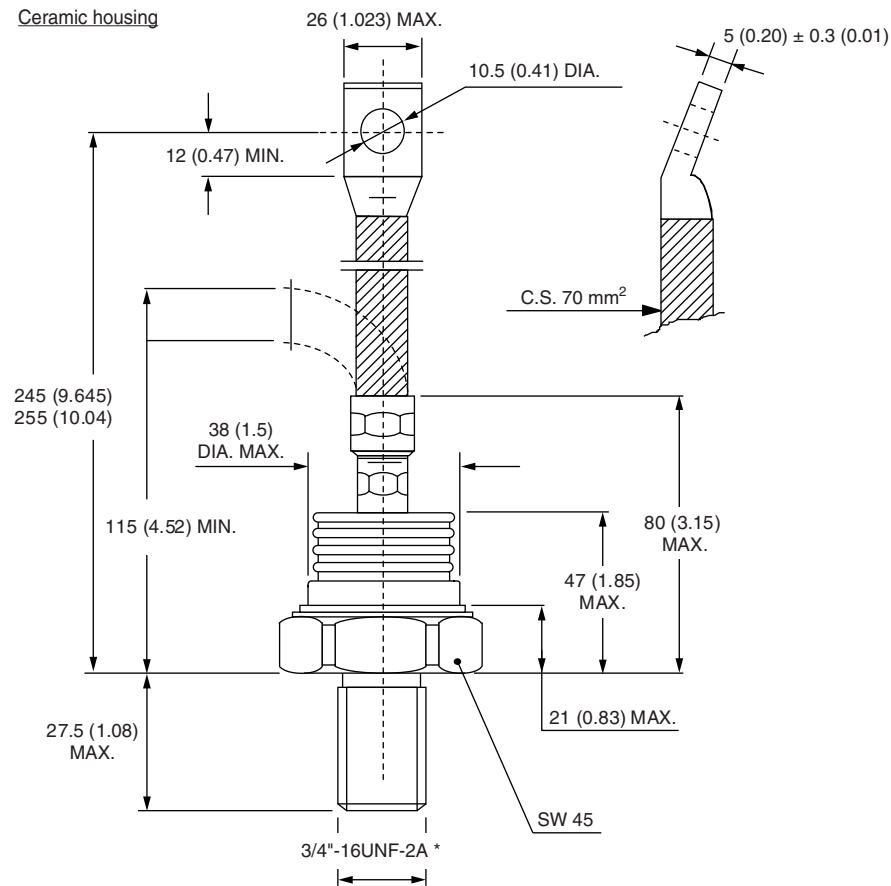

\*For metric device: M24 x 1.5 - length 21 (0.83) MAX.  
contact factory





## Disclaimer

ALL PRODUCT, PRODUCT SPECIFICATIONS AND DATA ARE SUBJECT TO CHANGE WITHOUT NOTICE TO IMPROVE RELIABILITY, FUNCTION OR DESIGN OR OTHERWISE.

Vishay Intertechnology, Inc., its affiliates, agents, and employees, and all persons acting on its or their behalf (collectively, "Vishay"), disclaim any and all liability for any errors, inaccuracies or incompleteness contained in any datasheet or in any other disclosure relating to any product.

Vishay makes no warranty, representation or guarantee regarding the suitability of the products for any particular purpose or the continuing production of any product. To the maximum extent permitted by applicable law, Vishay disclaims (i) any and all liability arising out of the application or use of any product, (ii) any and all liability, including without limitation special, consequential or incidental damages, and (iii) any and all implied warranties, including warranties of fitness for particular purpose, non-infringement and merchantability.

Statements regarding the suitability of products for certain types of applications are based on Vishay's knowledge of typical requirements that are often placed on Vishay products in generic applications. Such statements are not binding statements about the suitability of products for a particular application. It is the customer's responsibility to validate that a particular product with the properties described in the product specification is suitable for use in a particular application. Parameters provided in datasheets and/or specifications may vary in different applications and performance may vary over time. All operating parameters, including typical parameters, must be validated for each customer application by the customer's technical experts. Product specifications do not expand or otherwise modify Vishay's terms and conditions of purchase, including but not limited to the warranty expressed therein.

Except as expressly indicated in writing, Vishay products are not designed for use in medical, life-saving, or life-sustaining applications or for any other application in which the failure of the Vishay product could result in personal injury or death. Customers using or selling Vishay products not expressly indicated for use in such applications do so at their own risk and agree to fully indemnify and hold Vishay and its distributors harmless from and against any and all claims, liabilities, expenses and damages arising or resulting in connection with such use or sale, including attorneys fees, even if such claim alleges that Vishay or its distributor was negligent regarding the design or manufacture of the part. Please contact authorized Vishay personnel to obtain written terms and conditions regarding products designed for such applications.

No license, express or implied, by estoppel or otherwise, to any intellectual property rights is granted by this document or by any conduct of Vishay. Product names and markings noted herein may be trademarks of their respective owners.

## Material Category Policy

**Vishay Intertechnology, Inc. hereby certifies that all its products that are identified as RoHS-Compliant fulfill the definitions and restrictions defined under Directive 2011/65/EU of The European Parliament and of the Council of June 8, 2011 on the restriction of the use of certain hazardous substances in electrical and electronic equipment (EEE) - recast, unless otherwise specified as non-compliant.**

**Please note that some Vishay documentation may still make reference to RoHS Directive 2002/95/EC. We confirm that all the products identified as being compliant to Directive 2002/95/EC conform to Directive 2011/65/EU.**