

FC101



2067

PNP Epitaxial Planar
Silicon Composite Transistor

T-27-09

Low-Frequency General-Purpose Amp, Differential Amp Applications

©3109

Features

- Composite type with 2 transistors contained in the CP package currently in use, improving the mounting efficiency greatly.
- The FC101 is formed with two chips, being equivalent to the 2SA1622, placed in one package.
- Excellent in thermal equilibrium and pair capability and suitable for use in differential amp.

Absolute Maximum Ratings at Ta = 25°C

			unit
Collector to Base Voltage	V _{CB0}	-55	V
Collector to Emitter Voltage	V _{CEO}	-50	V
Emitter to Base Voltage	V _{EBO}	-6	V
Collector Current	I _C	-150	mA
Peak Collector Current	i _{cp}	-300	mA
Base Current	I _B	-30	mA
Collector Dissipation	P _C	200	mW
Total Power Dissipation	P _T	300	mW
Junction Temperature	T _J	150	°C
Storage Temperature	T _{stg}	-55 to +150	°C

Electrical Characteristics at Ta = 25°C

			min	typ	max	unit
Collector Cutoff Current	I _{CB0}	V _{CB} = -35V, I _E = 0			-0.1	μA
Emitter Cutoff Current	I _{EBO}	V _{EB} = -4V, I _C = 0			-0.1	μA
DC Current Gain	h _{FE}	V _{CE} = -6V, I _C = -1mA	160		600	
DC Current Gain Ratio	h _{FE(small/large)}	V _{CE} = -6V, I _C = -1mA	0.8	0.98		
Base to Emitter Voltage Drop	V _{BE(large-small)}	V _{CE} = -6V, I _C = -1mA		1.0	15	mV
Gain-Bandwidth Product	f _T	V _{CE} = -6V, I _C = -10mA		180		MHz
Output Capacitance	c _{ob}	V _{CB} = -6V, f = 1MHz		2.9		pF
C-E Saturation Voltage	V _{CE(sat)}	I _C = -50mA, I _B = -5mA	-0.11	-0.4		V
B-E Saturation Voltage	V _{BE(sat)}	I _C = -50mA, I _B = -5mA	-0.8	-1.0		V
C-B Breakdown Voltage	V _{(BR)CBO}	I _C = -10μA, I _E = 0	-55			V
C-E Breakdown Voltage	V _{(BR)CEO}	I _C = -1mA, R _{BE} = ∞	-50			V
E-B Breakdown Voltage	V _{(BR)EBO}	I _E = -10μA, I _C = 0	-6			V
Turn-ON Time	t _{on}	See specified Test Circuit.		0.15		μs
Storage Time	t _{stg}	"		0.60		μs
Fall Time	t _f	"		0.20		μs

Note) The specifications shown above are for each individual transistor.
Marking : 101

Switching Time Test Circuit

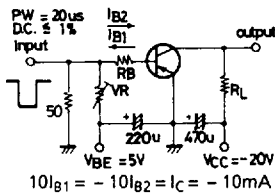

Electrical Connection

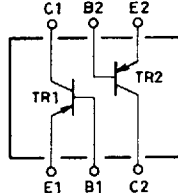

Case Outline 2067
(unit : mm)

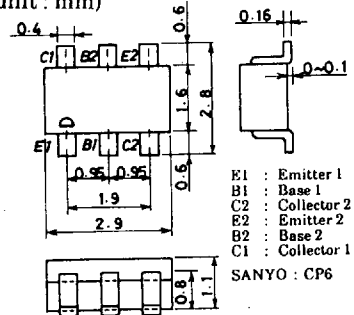

6299MO,TS No.3109-1/3

FC101

T-27-09

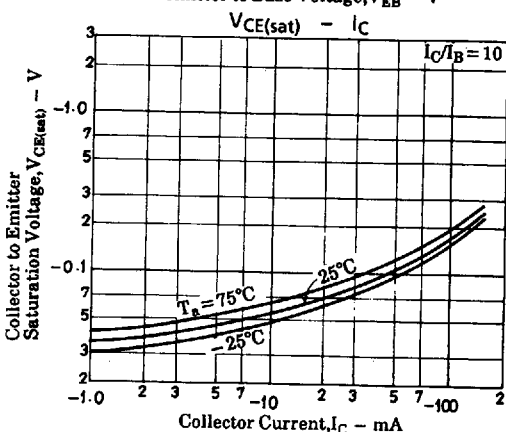
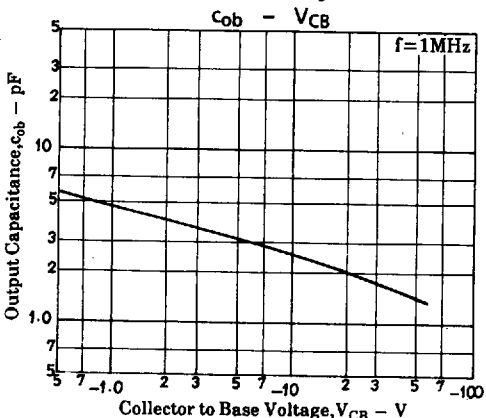
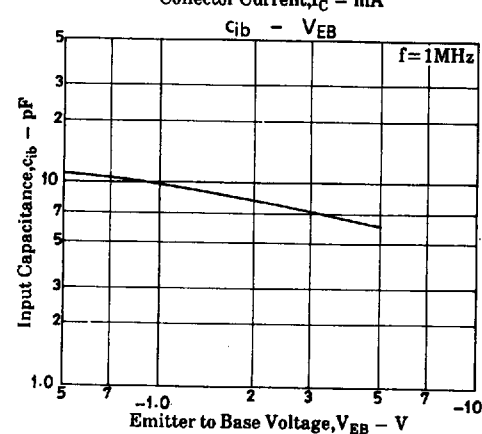
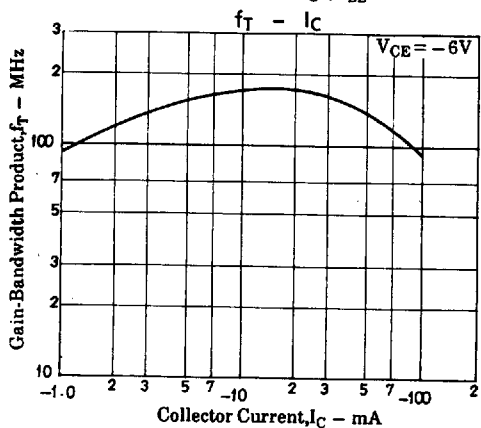
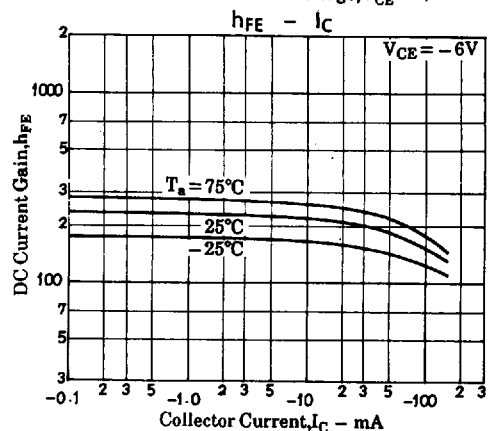
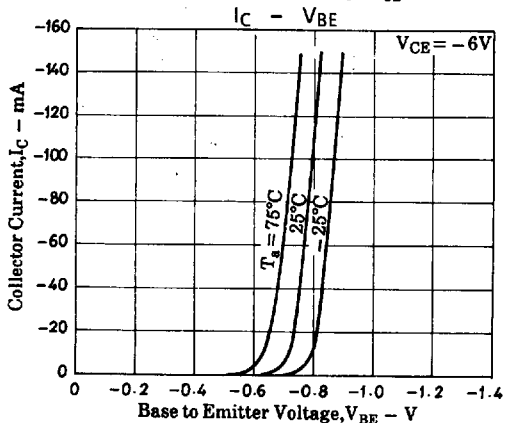
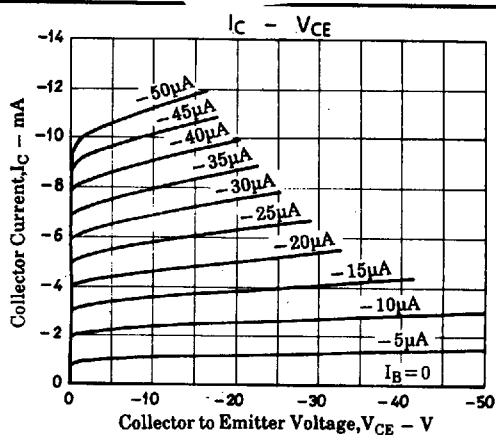
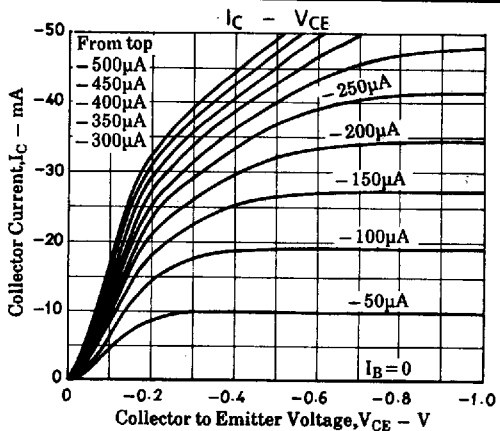

FC101

T-27-09

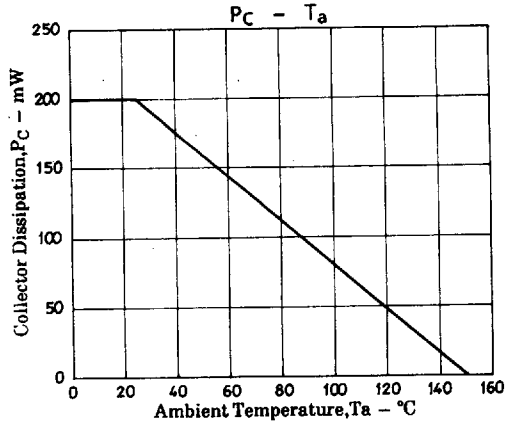
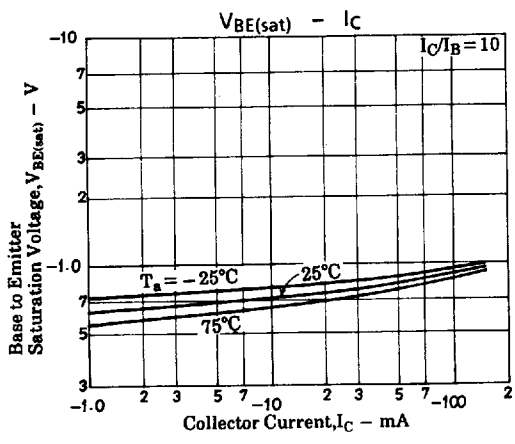

T-91-20

CASE OUTLINES OF SURFACE MOUNT TRANSISTORS

- All of Sanyo surface mount transistor case outlines are illustrated below.
- All dimensions are in mm, and dimensions which are not followed by min. or max. are represented by typical values.
- No marking is indicated.

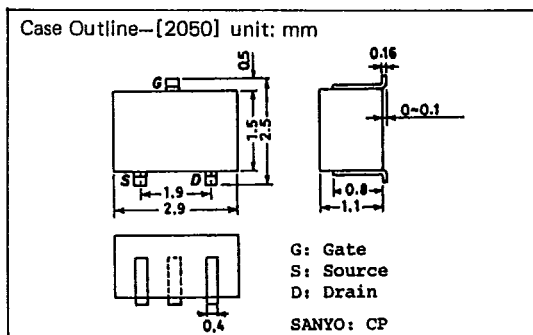
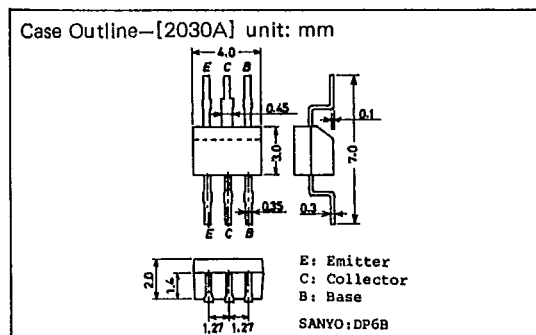
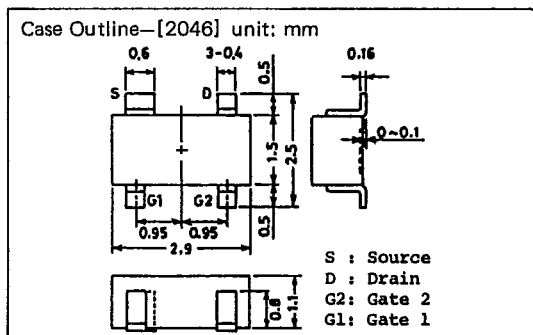
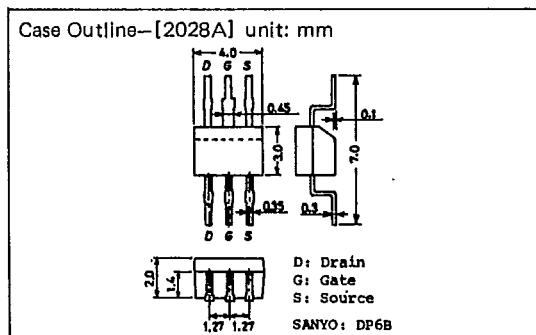
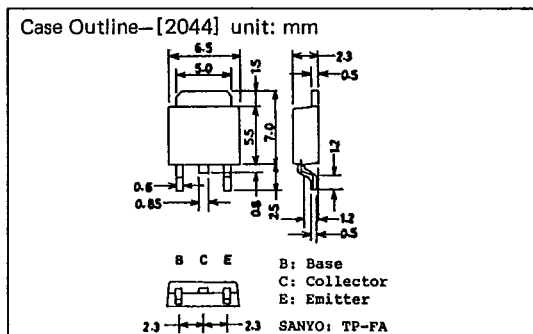
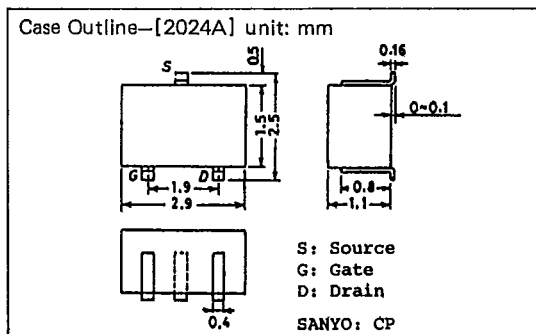
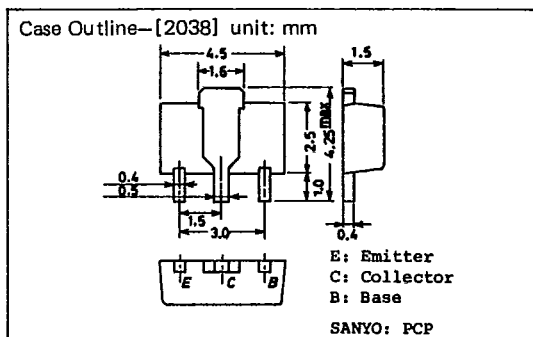
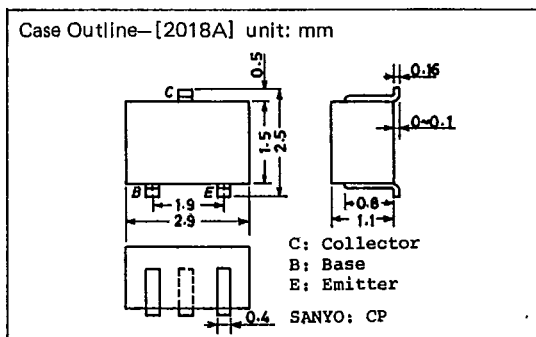

T-91-20

Case Outline—[2057] unit: mm

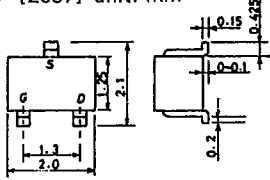

S: Source
G: Gate
D: Drain
SANYO: MCP

Case Outline—[2066] unit: mm

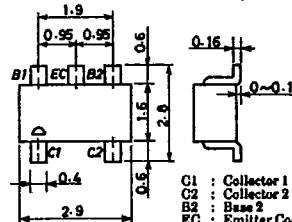

C1 : Collector 1
C2 : Collector 2
B2 : Base 2
EC : Emitter Common
B1 : Base 1
SANYO : CP6

Case Outline—[2058] unit: mm

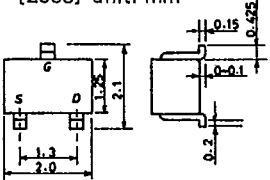

G: Gate
S: Source
D: Drain
SANYO: MCP

Case Outline—[2067] unit: mm

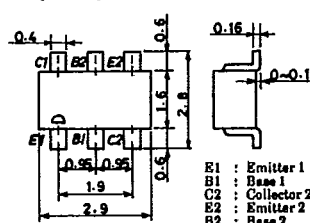

E1 : Emitter 1
B1 : Base 1
C2 : Collector 2
E2 : Emitter 2
B2 : Base 2
C1 : Collector 1
SANYO : CP6

Case Outline—[2059] unit: mm

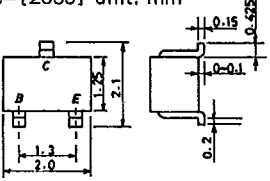

B: Base
C: Collector
E: Emitter
SANYO: MCP

Case Outline—[2068] unit: mm

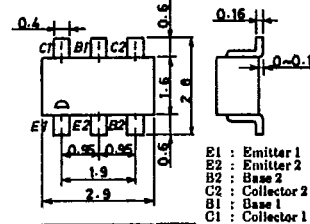

B1 : Emitter 1
E2 : Emitter 2
B2 : Base 2
C2 : Collector 2
B1 : Base 1
C1 : Collector 1
SANYO : CP6

Case Outline—[2062] unit: mm

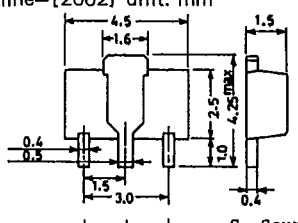

S: Source
D: Drain
G: Gate
SANYO: PCP

Case Outline—[2069] unit: mm

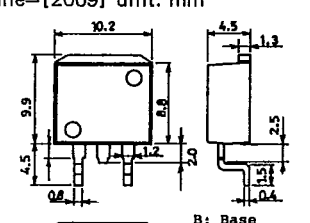

B: Base
C: Collector
E: Emitter
SANYO: SMP

Case Outline—[2065] unit: mm

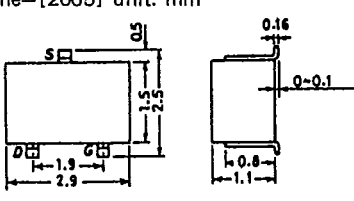

S: Source
D: Drain
G: Gate
SANYO: CP

Case Outline—[2070] unit: mm

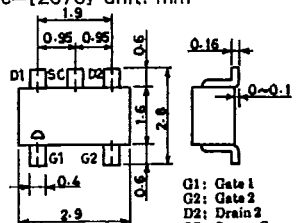

G1 : Gate 1
G2 : Gate 2
D2 : Drain 2
SC : Source Common
D1 : Drain 1
SANYO : CP6

T-9120

