

Dual, Low-Noise, High-PSRR, 300mA LDO without Bypass Capacitor

DESCRIPTION

The EUP7230 is a dual-channel low noise, low dropout. High PSRR, high accuracy CMOS voltage regulator. Performance features include low output noise, high ripple rejection ratio, low dropout and very fast turn-on times.

The EUP7230 is also fully compatible with low ESR ceramic capacitors, reducing cost and improving output stability. This high level of output stability is maintained even during frequent load fluctuations, due to the excellent transient response performance and high PSRR achieved across a broad range of frequencies.

The EN function allows the output of each regulator to be turned off independently, resulting in greatly reduced power consumption. The EUP7230 is available in small 1.6mm×1.6mm TDFN-6 and TSOT23-6 packages.

FEATURES

- 300mA Output Current (Per LDO)
- $30\mu V_{RMS}$ Low Noise Output
- 70dB PSRR at 1KHz
- Low 50uA Quiescent Current (Both LDOs active)
- 2.5V to 5.5V Input Voltage Range
- 380mV Dropout at 300mA Load
- Dual Shutdown pins Control Each Output
- Current Limiting and Thermal Protection
- Short Circuit Protection
- Available in TDFN-6 1.6mm×1.6mm and TSOT23-6 Packages
- RoHS Compliant and 100% Lead (Pb)-Free Halogen-Free

APPLICATIONS

- Cellular Phones
- Camera, Video Recordes
- PDAs
- Hand-held Equipment

Typical Application Circuit

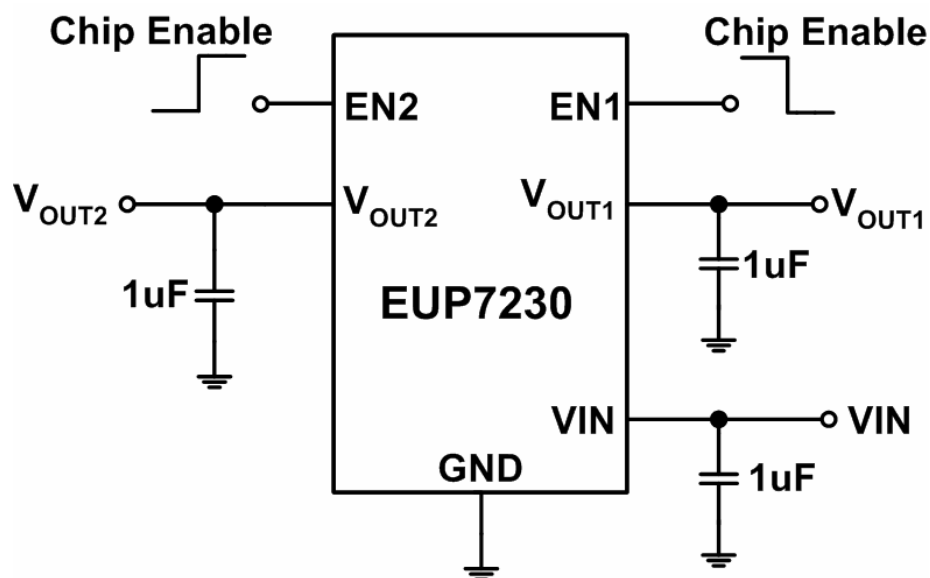

Figure 1.