

50-800 MHz Internally Matched IF Amplifier

Device Features

- 40 dBm Output IP3 at 70MHz, 14dBm/tone
- 27.0 dB Gain at 70MHz
- 21.0 dBm P1dB at 70 MHz
- Highly Reliable InGaP/GaAs HBT Technology
- Patented over voltage protection circuit
- Application: commercial wireless system

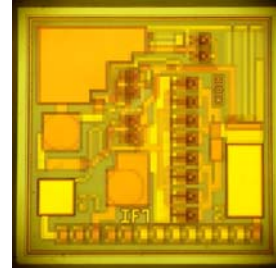

Target Device Performance ($T_a = 25^\circ\text{C}$)

Symbols	Parameters Test Conditions	Min	Typ	Max	Unit
Gain	70MHz	26.0	27.0		dB
	140MHz	25.8	26.8		
	250MHz	25.	26.7		
	500MHz	24.9	25.9		
S11	70MHz		-30.8		dB
	140MHz		-32.4		
	250MHz		-29.4		
	500MHz		-27.8		
S22	70MHz		-12.5		dB
	140MHz		-12.5		
	250MHz		-11.6		
	500MHz		-8.6		
OIP3	70MHz	39.2	41.2		dBm
	140MHz	38.5	40.8		
	250MHz	41.6	43.6		
	500MHz	39.4	41.4		
P1dB	70MHz	20.3	21.3		dBm
	140MHz	20.8	21.8		
	250MHz	20.7	21.7		
	500MHz	19.2	20.2		
Ic	Vc = 5.0V	85	95	105	mA
Vc			5.0		V
dG/dT			-0.003		$^\circ\text{C}$
Rth	Thermal Resistance		50		$^\circ\text{C/W}$

Test conditions unless otherwise noted.

1. Device performance is measured on BeRex evaluation board at 25°C, 50 ohm system.
2. OIP3 is measured on an eval-board with two tones separated by 1 MHz.

Absolute Maximum Ratings

Parameter	Rating
Operating Case temperature	-40 to +85°C
Storage Temperature	-40 to +155°C
Supply Voltage	6.0V
Max. Device Current	160mA
Input RF Power	23dBm

Operation of this device above any of these parameters may result in permanent damage.

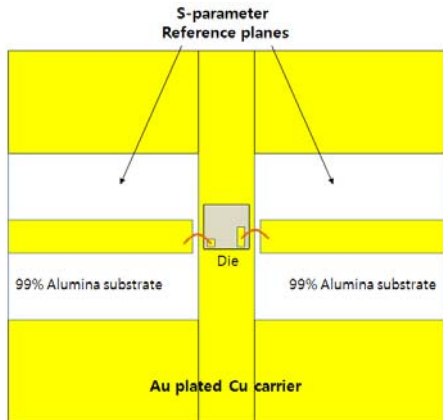

S-parameter test circuit

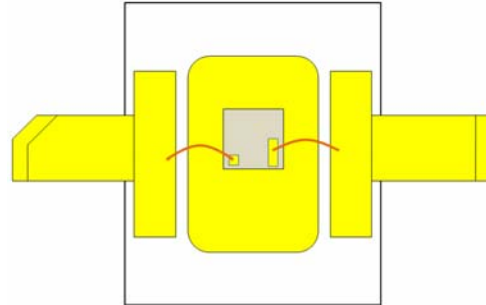

Chip attachment on PF083

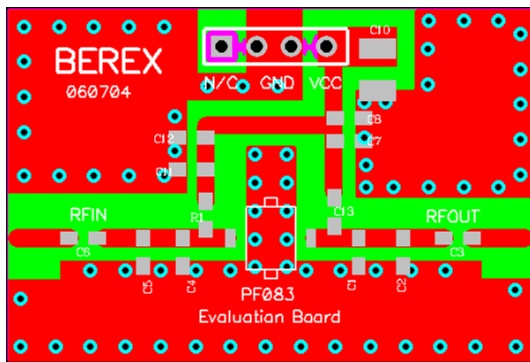

31mil thick FR4 PCB

Generic PF083 Evaluation Board

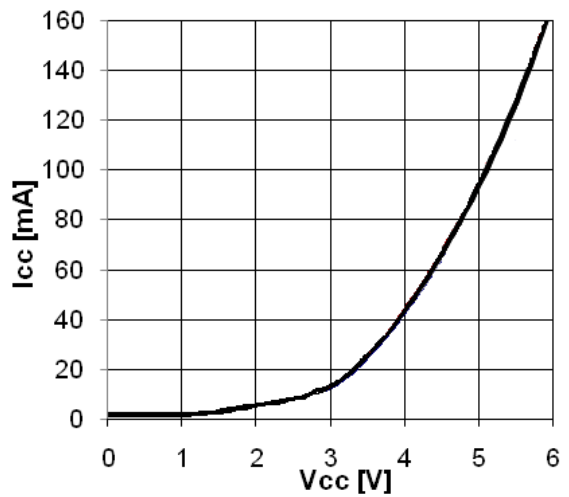

I-V Characteristics

Application Circuit: 50-800 MHz

Typical Performance ($V_{device} = 5V, I_c = 95\text{ mA}, T_a = 25^\circ C$)

Freq	MHz	70	140	250	500
S21	dB	27.0	26.8	26.7	25.9
S11	dB	-30.8	-32.4	-29.4	-27.8
S22	dB	-12.5	-12.5	-11.6	-8.64
P1	dBm	21.3	21.8	21.7	20.2
OIP3	dBm	41.2	40.8	43.6	41.4

Schematic Diagram		BOM	Tolerance	
		C1	100nF *100pF	± 5%
		C2	100nF *100pF	± 5%
		C3	100pF	± 5%
		C4	1000pF	± 5%
		C5	10uF	± 20%
		L1	1uH *12nH	±5%
*Application for RF Bandwidth				

Typical Device Data

S-parameters (Vc=5V, Ic=95mA, T=25°C)

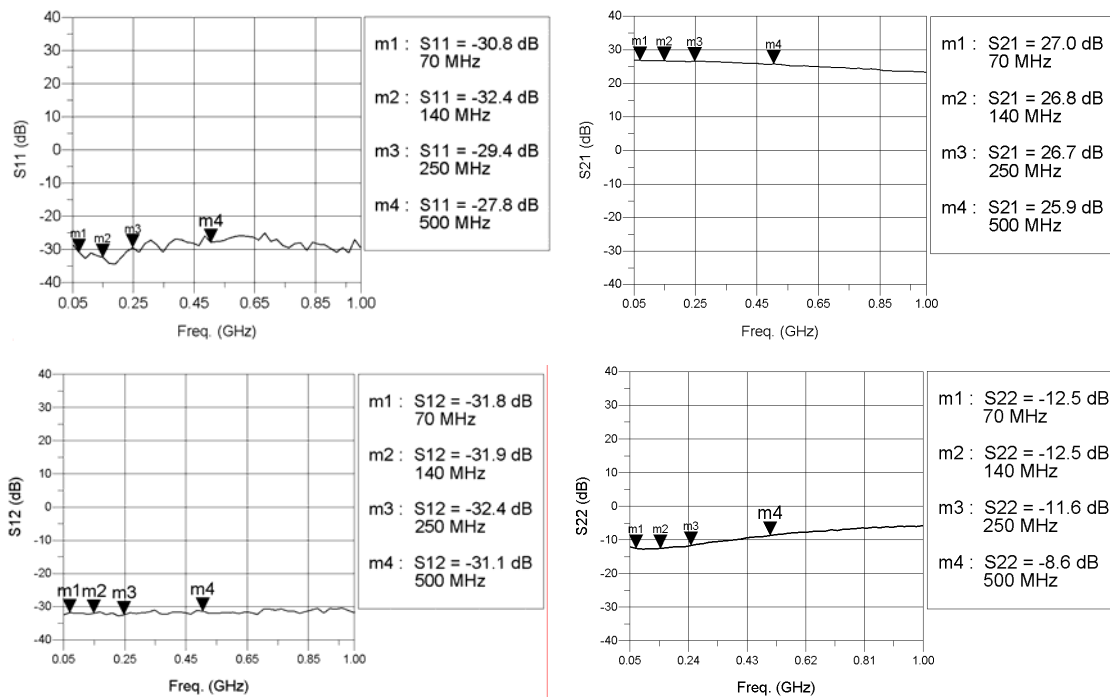

IF Bandwidth Application

S-parameters (Vc=5V, Ic=95mA, T=25°C)

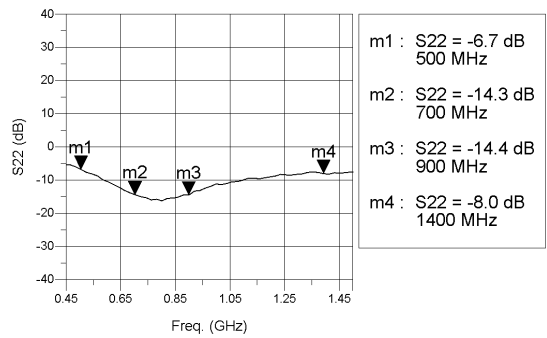
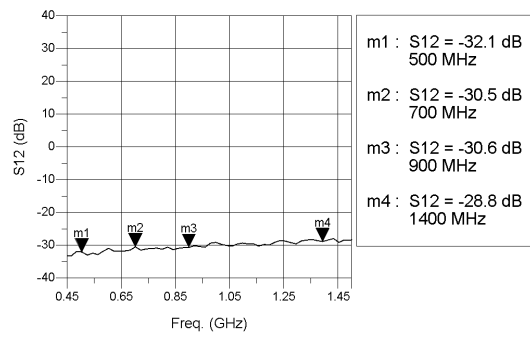
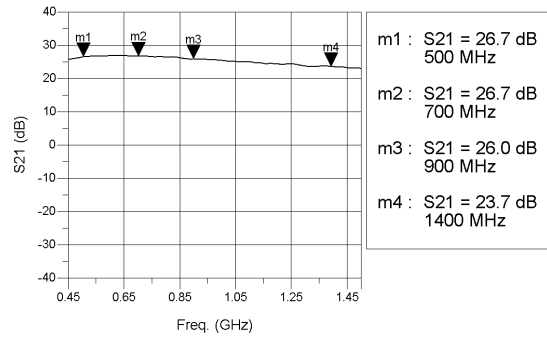
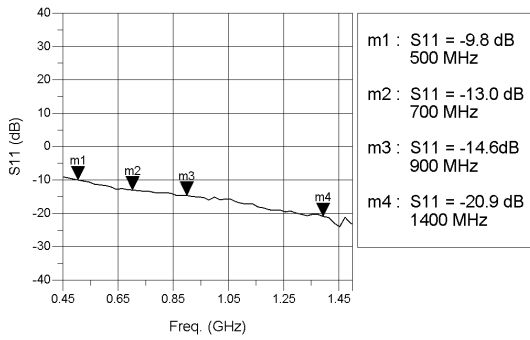

RF Bandwidth Application

Device Performance

P1dB-Gain

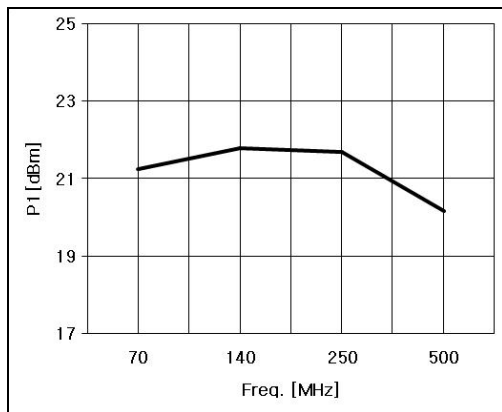

P1

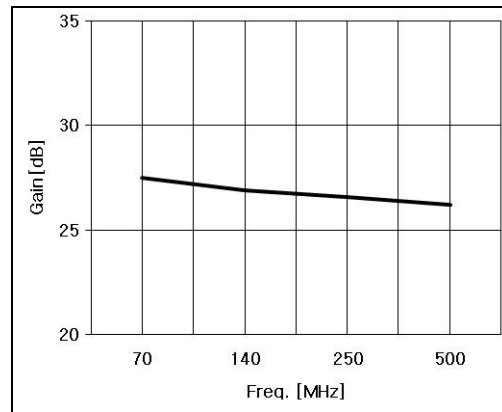

Gain

OIP3

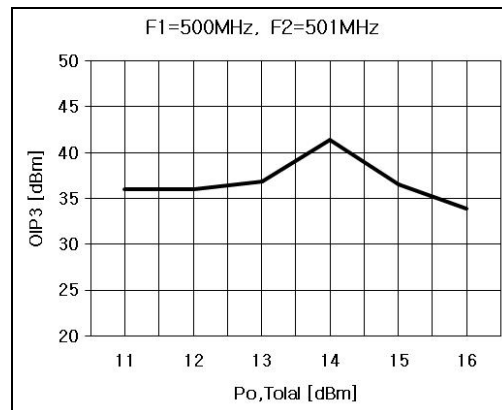
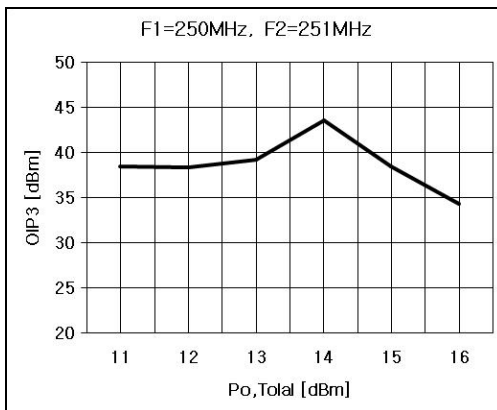
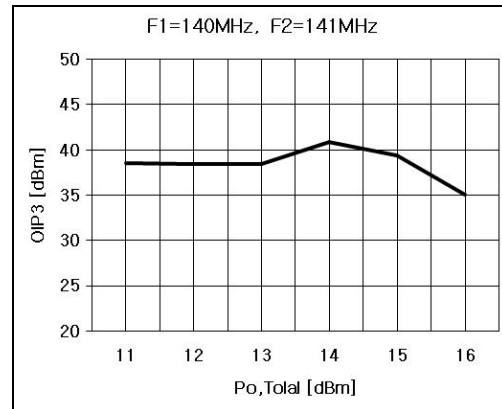
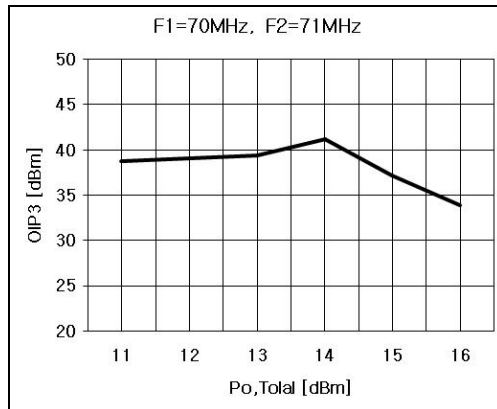

S-Parameter

IF Bandwidth Application ($V_c=5V$, $I_c=95mA$, $T=25^\circ C$)

Freq [MHz]	S11 [dB]	S11 [Ang]	S21 [dB]	S21 [Ang]	S12 [dB]	S12 [Ang]	S22 [dB]	S22 [Ang]
50	-28.586	-106.642	27.021	176.006	-32.384	2.863	-12.028	22.476
150	-32.368	153.226	26.801	156.233	-31.914	-7.256	-12.467	-21.072
250	-29.436	103.952	26.672	135.931	-32.394	-13.069	-11.622	-41.718
350	-30.806	74.122	26.319	119.315	-30.952	-23.766	-10.324	-58.0256
450	-28.025	57.612	26.102	102.363	-31.721	-36.896	-9.144	-72.792
550	-27.358	39.511	25.497	85.096	-31.882	-41.929	-8.246	-58.005
650	-26.156	34.536	25.184	69.233	-31.562	-51.528	-7.420	-94.494
750	-28.741	16.783	24.699	56.366	-30.987	-55.955	-6.775	102.541
850	-28.388	26.499	23.915	36.370	-30.922	-65.779	-6.329	-113.462

* Note : S-parameter includes 1 mil thick and 16-mil long Au wire

RF Bandwidth Application ($V_c=5V$, $I_c=95mA$, $T=25^\circ C$)

Freq [MHz]	S11 [dB]	S11 [Ang]	S21 [dB]	S21 [Ang]	S12 [dB]	S12 [Ang]	S22 [dB]	S22 [Ang]
500	-9.933	-62.036	26.655	140.862	-32.054	5.690	-6.741	95.975
600	-11.592	-69.083	27.012	114.561	-30.891	-10.142	-10.421	66.190
700	-12.970	-75.467	26.862	90.690	-30.452	-21.447	-14.326	28.112
800	-13.821	-81.199	26.486	70.988	-31.196	-39.664	-16.186	-31.310
900	-14.577	-89.643	26.003	51.737	-30.634	-47.501	-14.438	-74.036
1000	-15.849	-105.713	25.350	31.493	-29.676	-65.002	-11.274	-101.616
1100	-16.947	-116.273	25.174	17.566	-29.279	-73.650	-9.931	-115.456
1200	-18.847	-127.822	24.486	3.151	-29.542	-89.241	-8.173	-139.546
1300	-19.853	-145.186	23.909	-13.503	-29.542	-89.241	-8.173	-139.546
1400	-20.891	-168.828	23.719	-27.530	-28.848	-96.767	-7.982	-149.506
1500	-22.903	162.772	23.175	-42.466	-28.517	-107.766	-7.466	-156.464

* Note : S-parameter includes 1 mil thick and 16-mil long Au wire

Die Outline

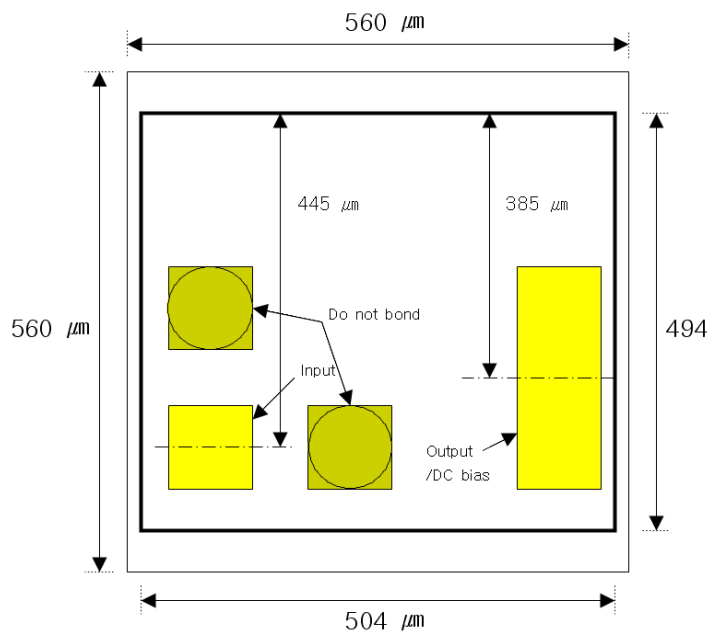

NOTES:

- 1) DIE THICKNESS 100 μm
- 2) BONDPAD METAL THICKNESS 2.8 μm
- 3) BACKSIDE METAL Au, 5 μm
- 4) DEVICE IS GROUNDED THROUGH VIA HOLES

ESD Rating

ESD Rating	Class 1C
Value	Passes <2000V
Test	Human Body Model (HBM)
Standard	JEDEC Standard JESD22-A114B

NATO CAGE code:

2	N	9	6	F
----------	----------	----------	----------	----------

NOTICE

BeRex Corporation reserves the right to make changes of product specification or to discontinue product at any time without notice.



Proper ESD procedures should be followed when handling this device.