

PROGRAMMABLE PRECISION REFERENCES

The KIA431 Series integrated circuits are three-terminal programmable shunt regulator diodes. These monolithic IC voltage reference operate as a low temperature coefficient zener which is programmable from V_{ref} to 36 volts with two external resistors. These devices exhibit a wide operating current range of 1.0 to 100mA with a typical dynamic impedance of 0.22 Ω . The characteristics of these references make them excellent replacements for zener diodes in many applications such as digital voltmeters, power supplies, and op amp circuitry. The 2.5 volt reference makes it convenient to obtain a stable reference from 5.0 volt logic supplies, and since the KIA431 Series operates as a shunt regulator, it can be used as either a positive or negative voltage reference.

FEATURES

- Device Code Name : KIA431 + V_{ref} Code + Package Code + Pin Configuration Code

ITEM	V_{ref} Code		Package Code		Pin Configuration Code (SOT-23 Only)	
	Code	Tolerance (%)	Code	Package	Code	Type
KIA431	Blank	± 2.2	Blank	TO-92	Blank	A
	A	± 1.0	F	SOT-89	2	B
	B	± 0.5	S	TSM		
			T	TSV		
			M	SOT-23		

- Low Dynamic Output Impedance : 0.22 Ω (Typ.).
- Sink Current Capability of 1.0 to 100mA.
- Equivalent Full-Range Temperature Coefficient of 50ppm/ $^{\circ}C$ (Typ.).
- Temperature Compensated for Operation Over Full Rated Operating Temperature Range.
- Low Output Noise Voltage.

LINE UP

Type No.	Operating Voltage(V)	Package	Marking
KIA431	2.5~36	TO-92	
KIA431A			
KIA431B			
KIA431F		SOT-89	3A
KIA431AF			3B
KIA431BF			3C
KIA431T		TSV	43C
KIA431AT			43A
KIA431BT			43B
KIA431S		TSM	43C
KIA431AS			43A
KIA431BS			43B
KIA431M		SOT-23 (A-Type)	43C
KIA431AM			43A
KIA431BM			43B
KIA431M2		SOT-23 (B-Type)	43F
KIA431AM2			43D
KIA431BM2			43E

* KIA431BT
(Tolerance : 0.5% , TSV package) : Under Development

PIN CONFIGURATION (SOT-23)

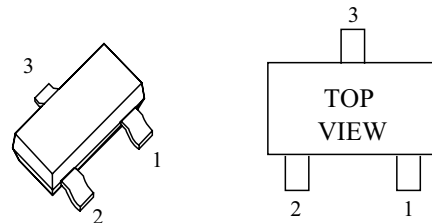

A-Type : 1. Cathode 2. Ref 3. Anode
B-Type : 1. Ref 2. Cathode 3. Anode

KIA431 Series

BLOCK DIAGRAM

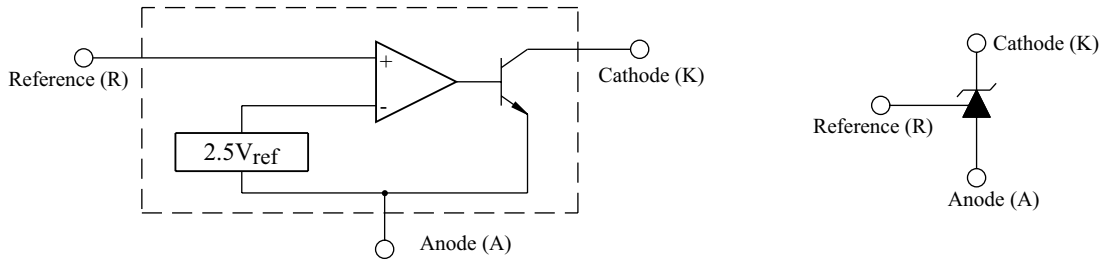

ORDERING INFORMATION

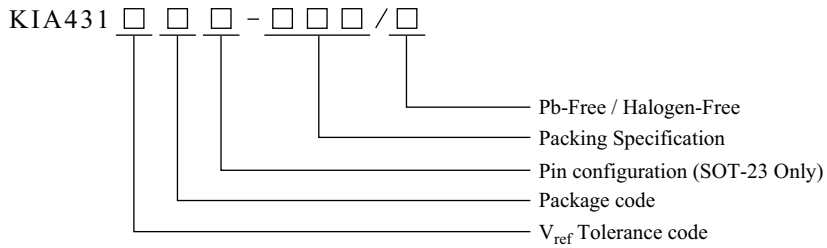

V_{ref} Tolerance code		Package Code		Pin Configuration (SOT-23 Only)		Pb-Free / Halogen-Free	
Blank	$\pm 2.2\%$	Blank	TO-92	Blank	A-Type	P	Pb-Free
A	$\pm 1.0\%$	F	SOT-89	2	B-Type	H	Halogen-Free
B	$\pm 0.5\%$	S	TSM				
		T	TSV				
		M	SOT-23				

Packing Specification	TO-92	AT : Taping of AMMO PACK type
	SOT-89	RTF : RTF type
	TSM / SOT-23	RTK : RTK type
	TSV	RTK : RTK type

KIA431 Series

MAXIMUM RATINGS (Ta=25)

(Full operating ambient temperature range applies unless otherwise noted.)

CHARACTERISTIC		SYMBOL	RATING	UNIT
Cathode To Anode Voltage		V_{KA}	37	V
Cathode Current Range, Continuous		I_K	-100 150	mA
Reference Input Current Range, Continuous		I_{ref}	-0.05 10	mA
Operating Junction Temperature		T_j	150	
Operating Temperature		T_{opr}	-40 85	
Storage Temperature		T_{stg}	-65 150	
Total Power Dissipation	KIA431	P_D	700	mW
	KIA431F		800	
	KIA431M (Note1)		350	
	KIA431S (Note2)		900	
	KIA431T		550	

Note1) Package mounted on 99.5% Alumina $10 \times 8 \times 0.6\text{mm}$

Note2) Package mounted on a ceramic board. ($600\text{mm}^3 \times 0.8\text{mm}$)

ELECTRICAL CHARACTERISTICS (Ta=25)

CHARACTERISTICS		SYMBOL	TEST CIRCUIT	TEST CONDITION	MIN.	TYP.	MAX.	UNIT	
Reference Input Voltage	KIA431	V_{ref}	Figure 1	$V_{KA}=V_{ref}, I_K=10\text{mA}$	2.440	2.495	2.550	V	
	KIA431A				2.470	2.495	2.520	V	
	KIA431B				2.4825	2.495	2.5075	V	
Reference Input Voltage Deviation Over Temperature Range		V_{ref}	Figure 1 (Note 1)	$V_{KA}=V_{ref}, I_K=10\text{mA}$	-	7.0	30	mV	
Ratio of Change in Reference Input Voltage to Change in Cathode to Anode Voltage		V_{ref}/V_{KA}	Figure 2	$I_K=10\text{mA}$	$V_{KA}=10\text{V}$ V_{ref}	-	-1.4	-2.7	mV/V
					$V_{KA}=36\text{V}$ 10V	-	-1.0	-2.0	
Reference Input Current	Ta=25	I_{ref}	Figure 2	$I_K=10\text{mA}, R1=10\text{k}, R2=$	-	1.8	4.0	μA	
	Ta=T _{opr}				-	-	6.5		
Reference Input Current Deviation Over Temperature Range		I_{ref}	Figure 2	$I_K=10\text{mA}, R1=10\text{k}, R2=$	-	0.8	2.5	μA	
Minimum Cathode Current For Regulation		I_{min}	Figure 1	$V_{KA}=V_{ref}$	-	0.5	1.0	mA	
Off-State Cathode Current		I_{off}	Figure 3	$V_{KA}=36\text{V}, V_{ref}=0\text{V}$	-	2.6	1000	nA	
Dynamic Impedance		Z_{ka}	Figure 1 (Note 2)	$V_{KA}=V_{ref}, I_K=1.0 \sim 100\text{mA}, f=1.0\text{kHz}$	-	0.22	-		

KIA431 Series

FIGURE 1-TEST CIRCUIT FOR $V_{KA} = V_{ref}$

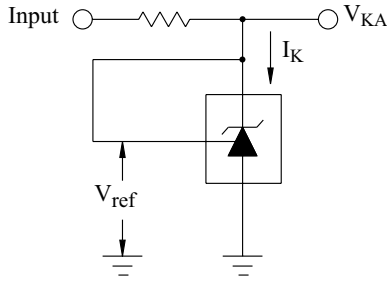
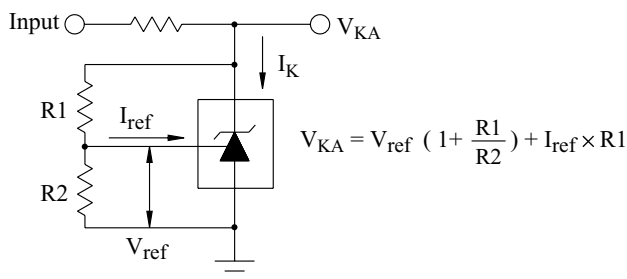
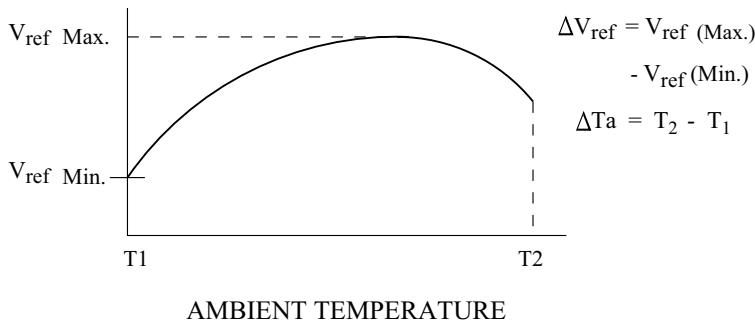

FIGURE 2-TEST CIRCUIT FOR $V_{KA} > V_{ref}$



Note 1:

The deviation parameter V_{ref} is defined as the differences between the maximum and minimum values obtained over the full operating ambient temperature range that applies.



The average temperature coefficient of the Reference input voltage, V_{ref} , is defined as:

$$V_{ref} \left(\frac{\text{ppm}}{\text{Ta}} \right) = \frac{\left(\frac{V_{ref}}{V_{ref \text{ at } 25}} \right) \times 10^6}{\text{Ta}}$$

$$= \frac{V_{ref} \times 10^6}{\text{Ta}(V_{ref \text{ at } 25})}$$

V_{ref} can be positive or negative depending on whether $V_{ref \text{ Min.}}$ or $V_{ref \text{ Max.}}$ occurs at the lower ambient temperature.

FIGURE 3-TEST CIRCUIT FOR I_{off}

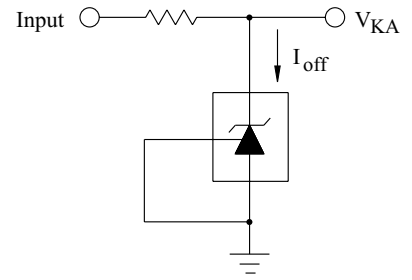

Example : $V_{ref} = 8.0\text{mV}$ and slope is positive,
 $V_{ref \text{ at } 25} = 2.495\text{V}$, $T_a = 70$

$$V_{ref} = \frac{0.008 \times 10^6}{70 \times (2.495)} = 45.8 \text{ ppm/}$$

Note 2: The dynamic impedance Z_{ka} is defined as:

$$|Z_{ka}| = \frac{V_{KA}}{I_k}$$

When the device is programmed with two external resistors, R1 and R2, (refer to Figure 2) the total dynamic impedance of the circuit is defined as:

$$|Z_{ka}| = |Z_{ka}| \left(1 + \frac{R1}{R2} \right)$$

KIA431 Series

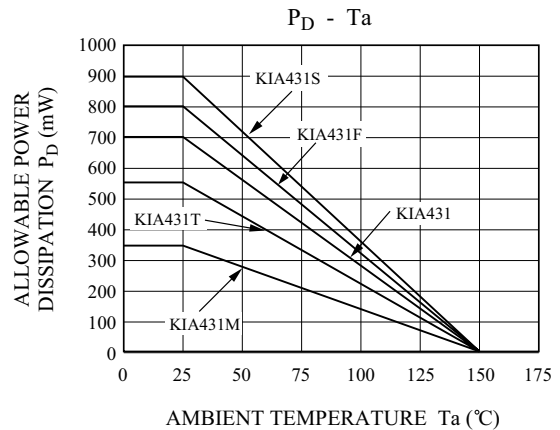
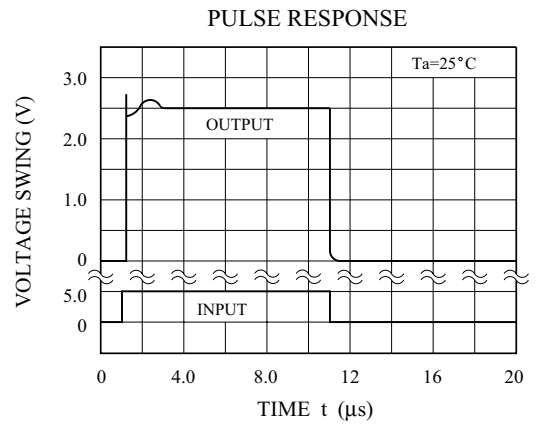
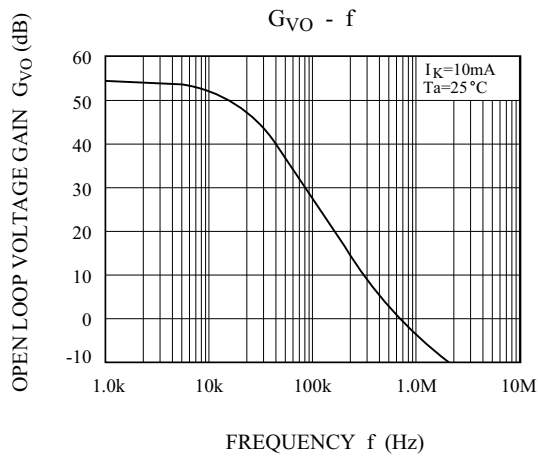
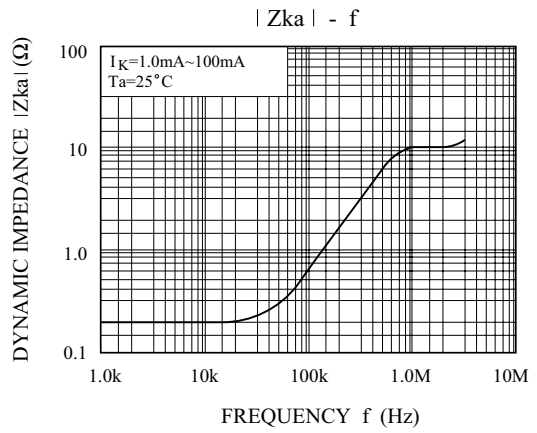
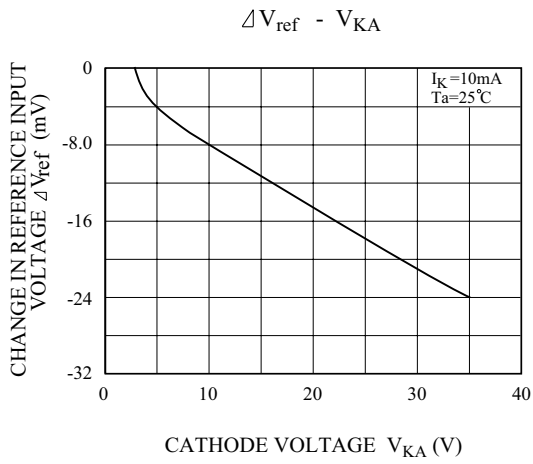
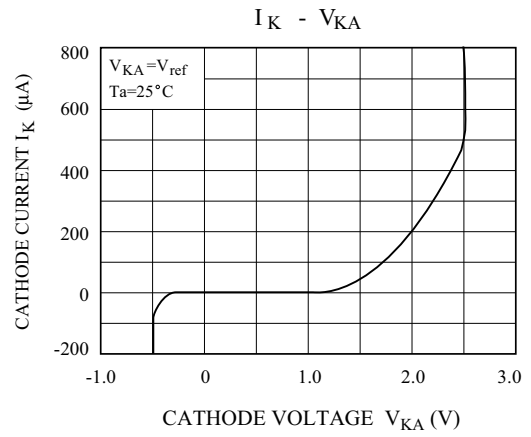
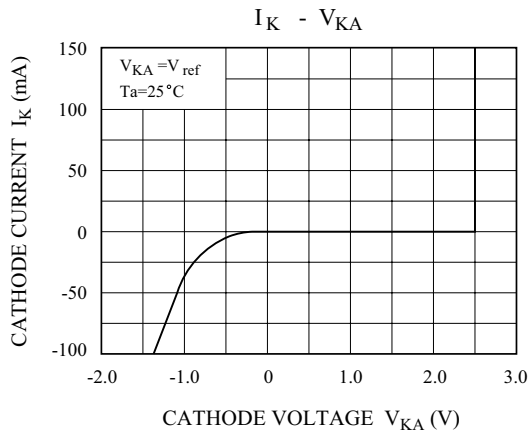

KIA431 Series

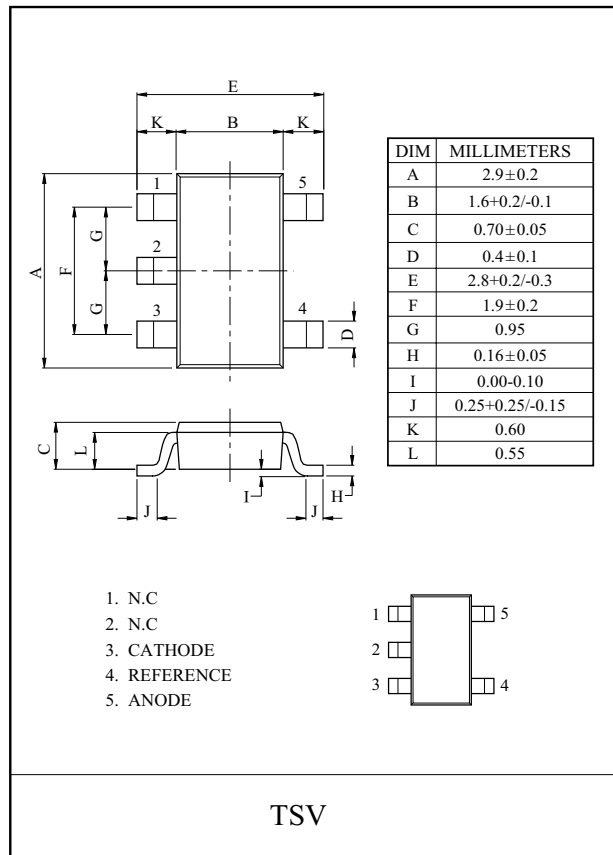
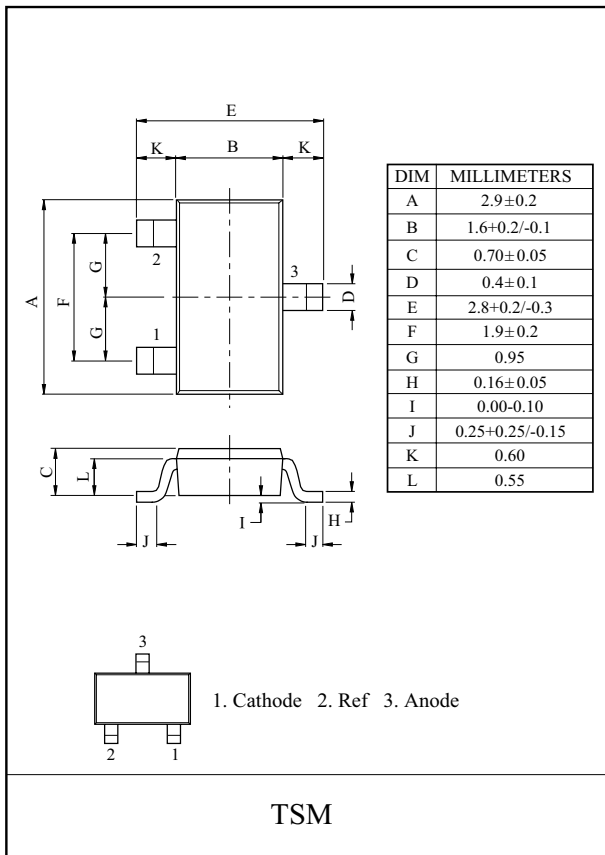
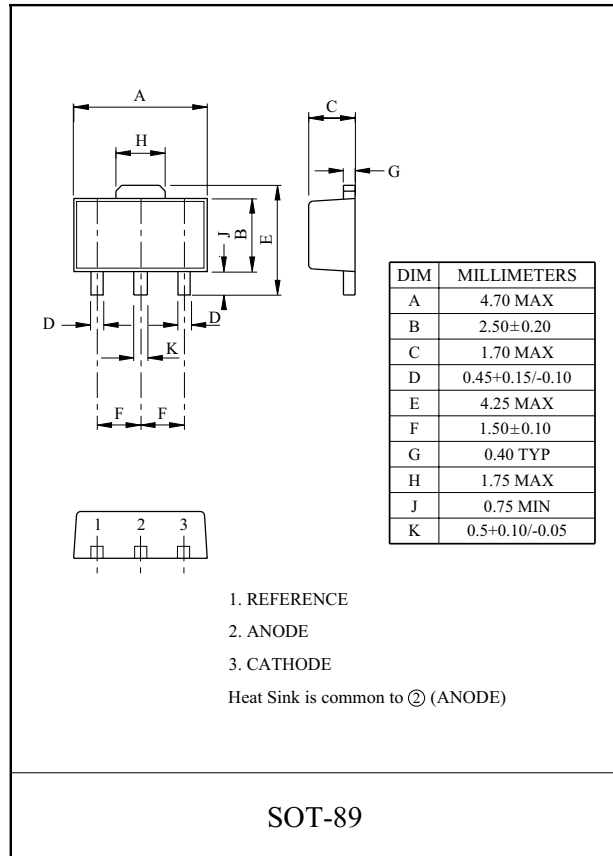
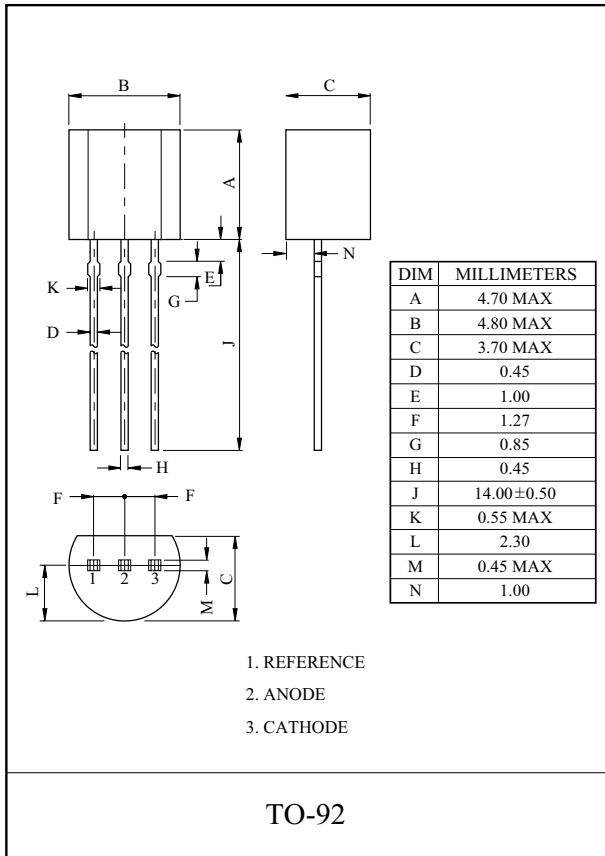

KIA431 Series

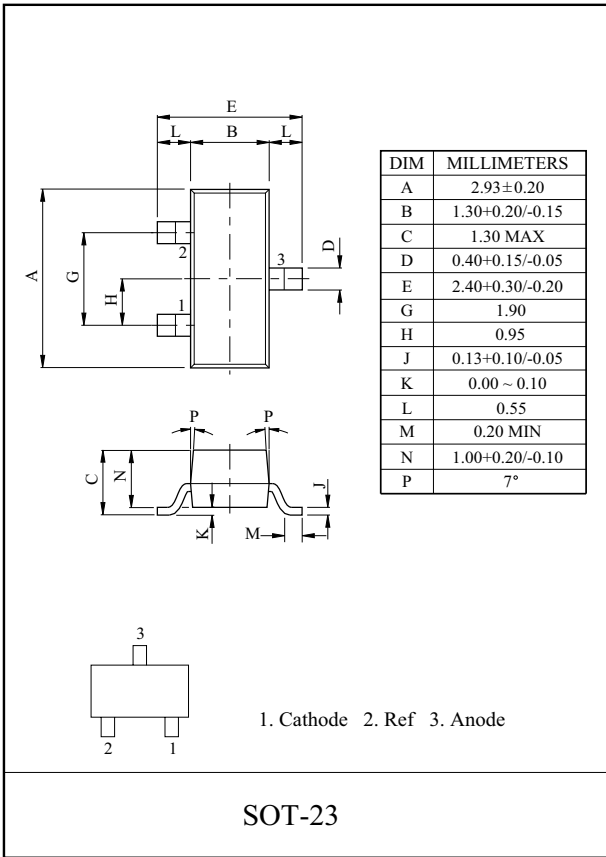

KIA431 Series

PRECAUTION FOR USE

Lead-Free Soldering Condition.

Elements mounting styles of electronic devices are gaining in further diversification over recent years, and needs for components are all the more expanding in varieties. Especially, surface mounting is steadily penetrating into industrial segments as a world-wide popular technical trend. Although exposure to high temperature is inevitable during soldering we recommend limiting the soldering temperature to low levels as shown in figure for the sake of retaining inherent excellent reliability.

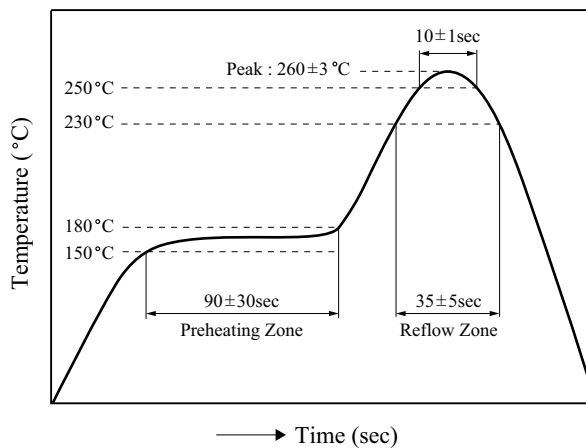

[Lead-Free Soldering Temperature Profile]

1. When employing solder reflow method

1) Soldering Condition

Standard Condition : 250 (Temperature), 10 ± 1sec. (Time)

Peak Condition : 260 ± 3

2) Recommend temperature profile

3) Precautions on heating method

When resin is kept exposed to high temperature for a long time, device reliability may be marred.

Therefore, it is essential to complete soldering in the shortest time possible to prevent temperature of resin from rising.

2. When employing halogen lamps or infrared-ray heaters

When halogen lamps or infrared-ray heaters are used, avoid direct irradiation onto resin surfaces; such devices cause extensive localized temperature rise.

Please keep a reflow solder operating when Surface Mount Package's Soldering.