



# CED12P10/CEU12P10

## P-Channel Enhancement Mode Field Effect Transistor

### FEATURES

- -100V, -9A,  $R_{DS(ON)} = 315m\Omega$  @  $V_{GS} = -10V$ .
- Super high dense cell design for extremely low  $R_{DS(ON)}$ .
- High power and current handing capability.
- Lead free product is acquired.
- TO-251 & TO-252 package.

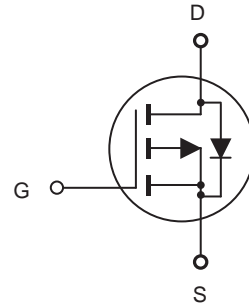

### ABSOLUTE MAXIMUM RATINGS $T_C = 25^\circ\text{C}$ unless otherwise noted

| Parameter   | Symbol         | Limit      | Units               |
|---|----------------|------------|---------------------|
| Drain-Source Voltage  | $V_{DS}$       | -100       | V                   |
| Gate-Source Voltage   | $V_{GS}$       | $\pm 30$   | V                   |
| Drain Current-Continuous  | $I_D$          | -9         | A                   |
| Drain Current-Pulsed <sup>a</sup>   | $I_{DM}$       | -36        | A                   |
| Maximum Power Dissipation @ $T_C = 25^\circ\text{C}$<br>- Derate above $25^\circ\text{C}$ | $P_D$          | 50         | W                   |
|   |                | 0.4        | W/ $^\circ\text{C}$ |
| Operating and Store Temperature Range   | $T_J, T_{stg}$ | -55 to 150 | $^\circ\text{C}$    |

### Thermal Characteristics

| Parameter                               | Symbol          | Limit | Units              |
|---|-----------------|-------|--------------------|
| Thermal Resistance, Junction-to-Case    | $R_{\theta JC}$ | 2.5   | $^\circ\text{C/W}$ |
| Thermal Resistance, Junction-to-Ambient | $R_{\theta JA}$ | 50    | $^\circ\text{C/W}$ |



# CED12P10/CEU12P10

## Electrical Characteristics $T_A = 25^\circ\text{C}$ unless otherwise noted

| Parameter  | Symbol       | Test Condition  | Min  | Typ  | Max  | Units      |
|--|--------------|---|------|------|------|------------|
| <b>Off Characteristics</b>   |              |   |      |      |      |            |
| Drain-Source Breakdown Voltage   | $BV_{DSS}$   | $V_{GS} = 0V, I_D = -250\mu A$                                      | -100 |      |      | V          |
| Zero Gate Voltage Drain Current  | $I_{DSS}$    | $V_{DS} = -100V, V_{GS} = 0V$                                       |      |      | -1   | $\mu A$    |
| Gate Body Leakage Current, Forward   | $I_{GSSF}$   | $V_{GS} = 30V, V_{DS} = 0V$   |      |      | 100  | nA         |
| Gate Body Leakage Current, Reverse   | $I_{GSSR}$   | $V_{GS} = -30V, V_{DS} = 0V$  |      |      | -100 | nA         |
| <b>On Characteristics<sup>c</sup></b>  |              |   |      |      |      |            |
| Gate Threshold Voltage   | $V_{GS(th)}$ | $V_{GS} = V_{DS}, I_D = -250\mu A$                                  | -2   |      | -4   | V          |
| Static Drain-Source On-Resistance  | $R_{DS(on)}$ | $V_{GS} = -10V, I_D = -4.7A$  |      | 260  | 315  | m $\Omega$ |
| Forward Transconductance   | $g_{FS}$     | $V_{DS} = -40V, I_D = -4.7A$  |      | 3.5  |      | S          |
| <b>Dynamic Characteristics<sup>d</sup></b>   |              |   |      |      |      |            |
| Input Capacitance  | $C_{iss}$    | $V_{DS} = -25V, V_{GS} = 0V,$<br>$f = 1.0\text{ MHz}$               |      | 625  |      | pF         |
| Output Capacitance   | $C_{oss}$    |   |      | 140  |      | pF         |
| Reverse Transfer Capacitance   | $C_{rss}$    |   |      | 45   |      | pF         |
| <b>Switching Characteristics<sup>d</sup></b>   |              |   |      |      |      |            |
| Turn-On Delay Time   | $t_{d(on)}$  | $V_{DD} = -50V, I_D = -11A,$<br>$V_{GS} = -10V, R_{GEN} = 25\Omega$ |      | 15   | 30   | ns         |
| Turn-On Rise Time  | $t_r$        |   |      | 12   | 25   | ns         |
| Turn-Off Delay Time  | $t_{d(off)}$ |   |      | 31   | 60   | ns         |
| Turn-Off Fall Time   | $t_f$        |   |      | 31   | 60   | ns         |
| Total Gate Charge  | $Q_g$        | $V_{DS} = -80V, I_D = -11A,$<br>$V_{GS} = -10V$                     |      | 15.6 | 20   | nC         |
| Gate-Source Charge   | $Q_{gs}$     |   |      | 3.6  |      | nC         |
| Gate-Drain Charge  | $Q_{gd}$     |   |      | 6.0  |      | nC         |
| <b>Drain-Source Diode Characteristics and Maximum Ratings</b>  |              |   |      |      |      |            |
| Drain-Source Diode Forward Current <sup>b</sup>  | $I_S$        |   |      |      | -9   | A          |
| Drain-Source Diode Forward Voltage <sup>c</sup>  | $V_{SD}$     | $V_{GS} = 0V, I_S = -9A$  |      |      | -1.5 | V          |
| <b>Notes :</b><br>a.Repetitive Rating : Pulse width limited by maximum junction temperature.<br>b.Surface Mounted on FR4 Board, $t \leq 10$ sec.<br>c.Pulse Test : Pulse Width $\leq 300\mu s$ , Duty Cycle $\leq 2\%$ .<br>d.Guaranteed by design, not subject to production testing. |              |   |      |      |      |            |



# CED12P10/CEU12P10

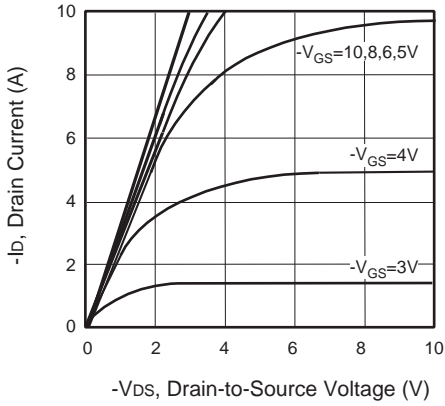

Figure 1. Output Characteristics

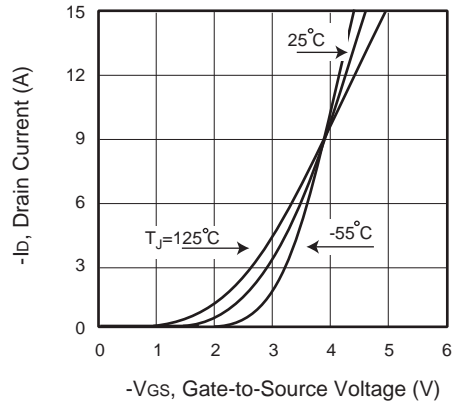

Figure 2. Transfer Characteristics

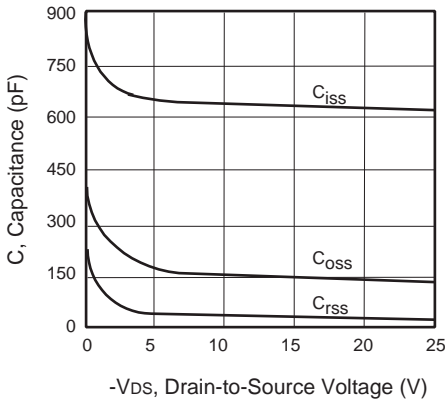

Figure 3. Capacitance

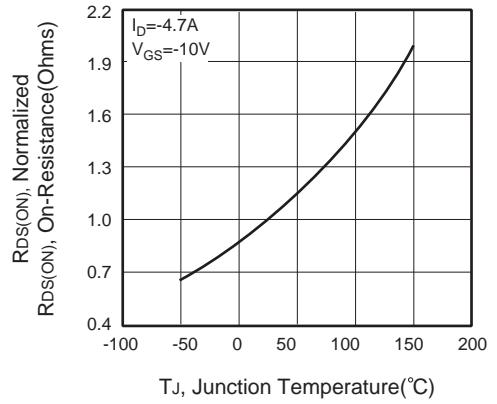

Figure 4. On-Resistance Variation with Temperature

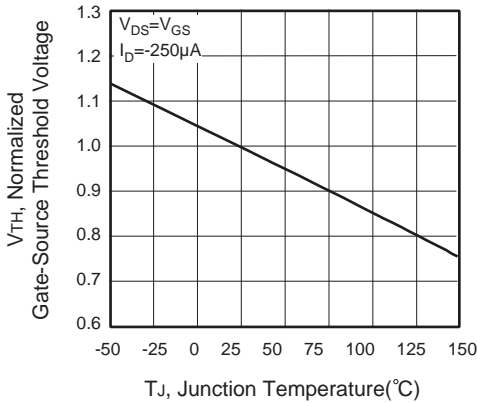

Figure 5. Gate Threshold Variation with Temperature

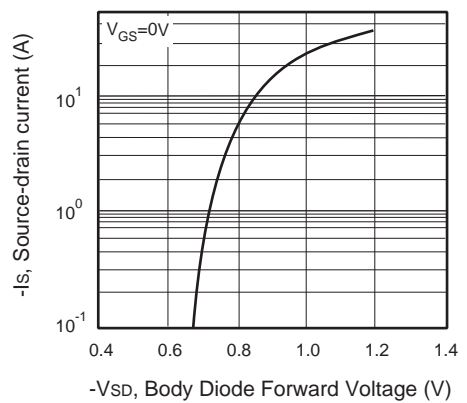

Figure 6. Body Diode Forward Voltage Variation with Source Current



# CED12P10/CEU12P10

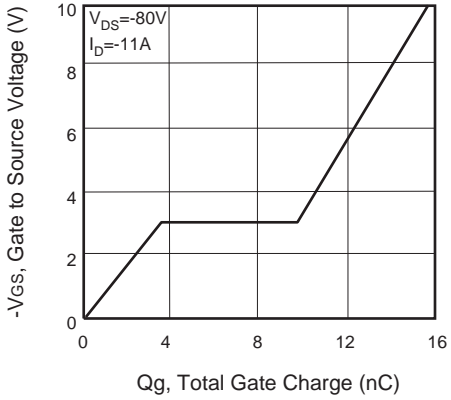

Figure 7. Gate Charge

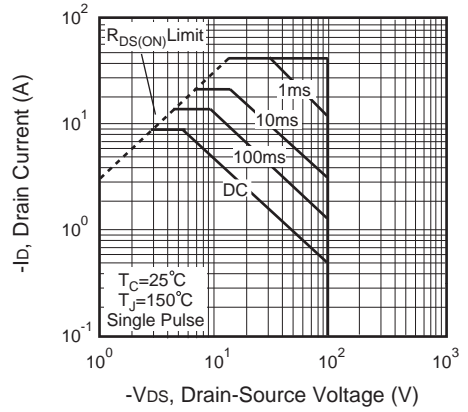

Figure 8. Maximum Safe Operating Area

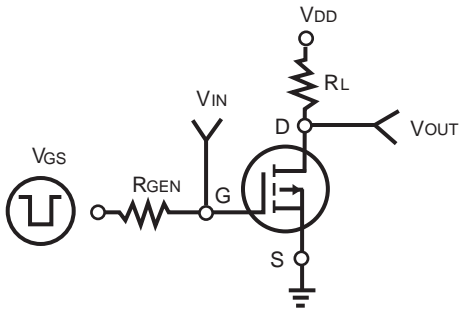

Figure 9. Switching Test Circuit

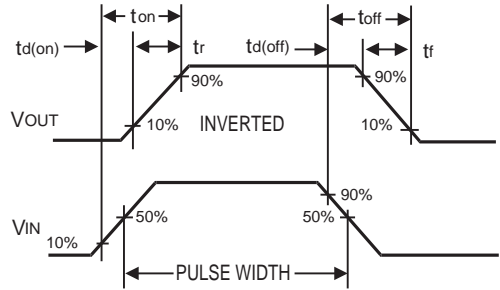

Figure 10. Switching Waveforms

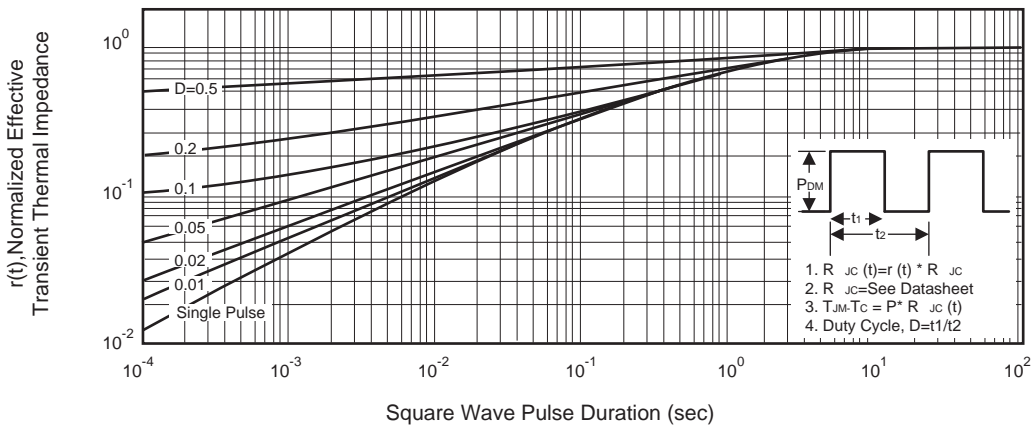

Figure 11. Normalized Thermal Transient Impedance Curve