

3216 Size

**Chip Multilayer Diplexer
for CELL/PCS**

FSLF-080ML

All the technical data and information contained
herein are subject to change without notice.



Shape & Size

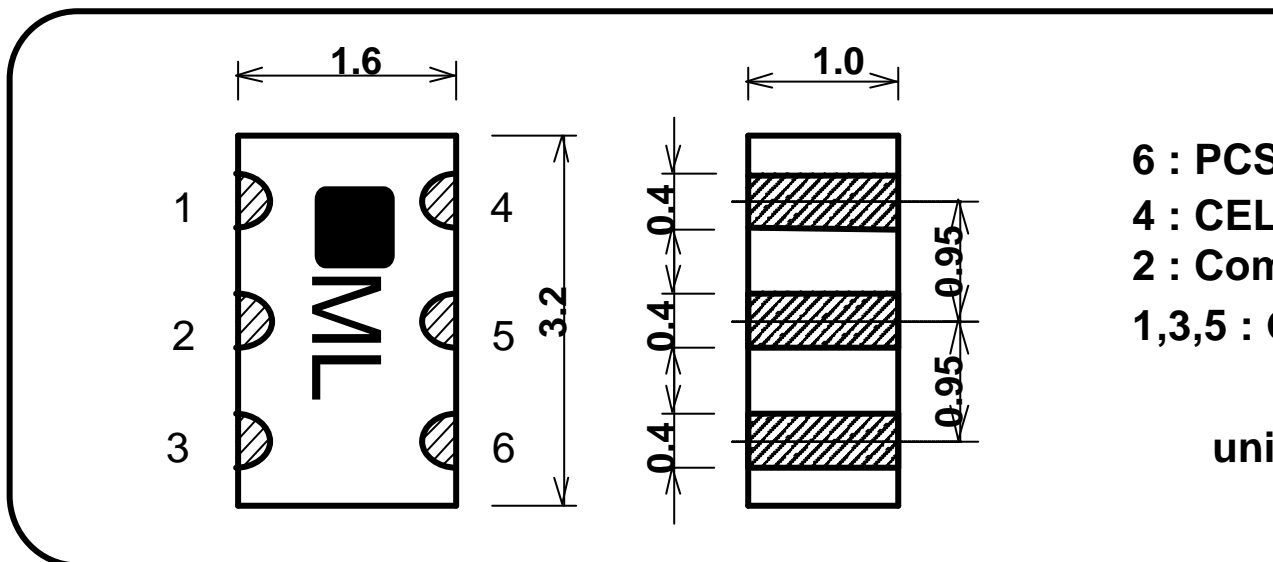

Specifications

Frequency Range	f1:824-894MHz	Attenuation AMPS <=>C
	f2:1850-1990MHz	
Insertion Loss in f1 AMPS <=>Common	0.4dB Max.(at +25deg) 0.5dB Max.(at -35to+85deg)	Attenuation PCS <=>Com
Insertion Loss in f2 PCS <=>Common	0.55 dB Max.(at +25deg) 0.65dB Max.(at -35to+85deg)	Power Cap Temperatur
Return Loss (all port)	12 dB Min.	

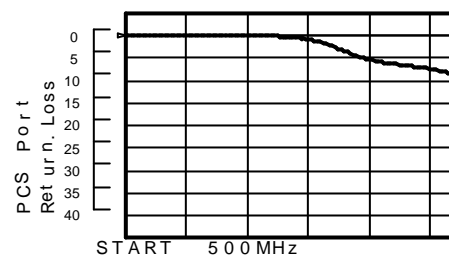
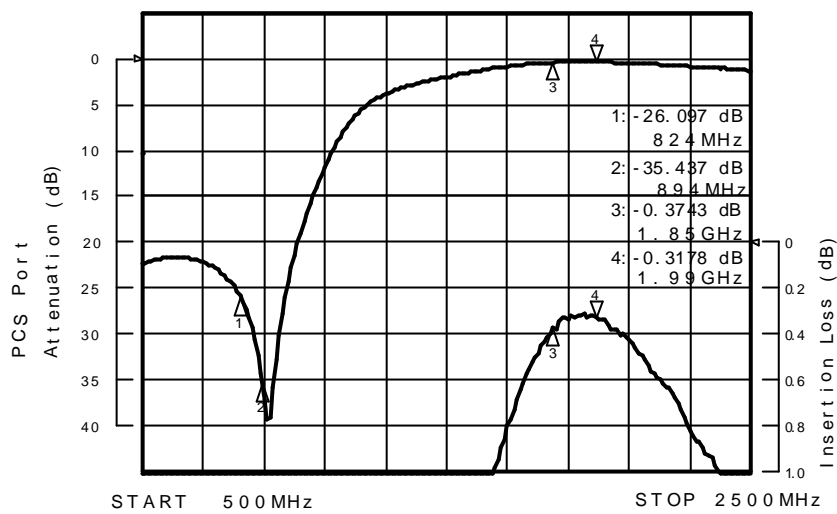
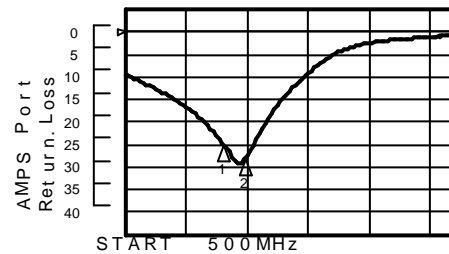
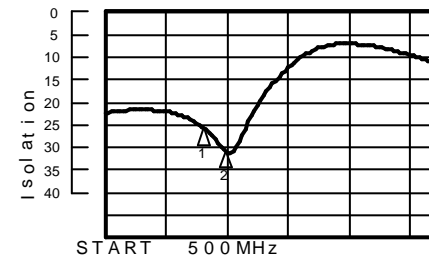
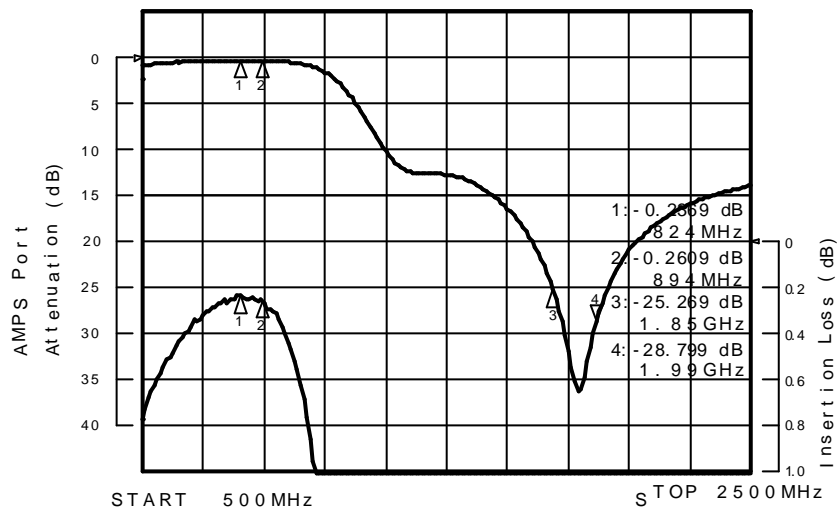

All the technical data and information contained herein are subject to change without notice.

Foot Pattern

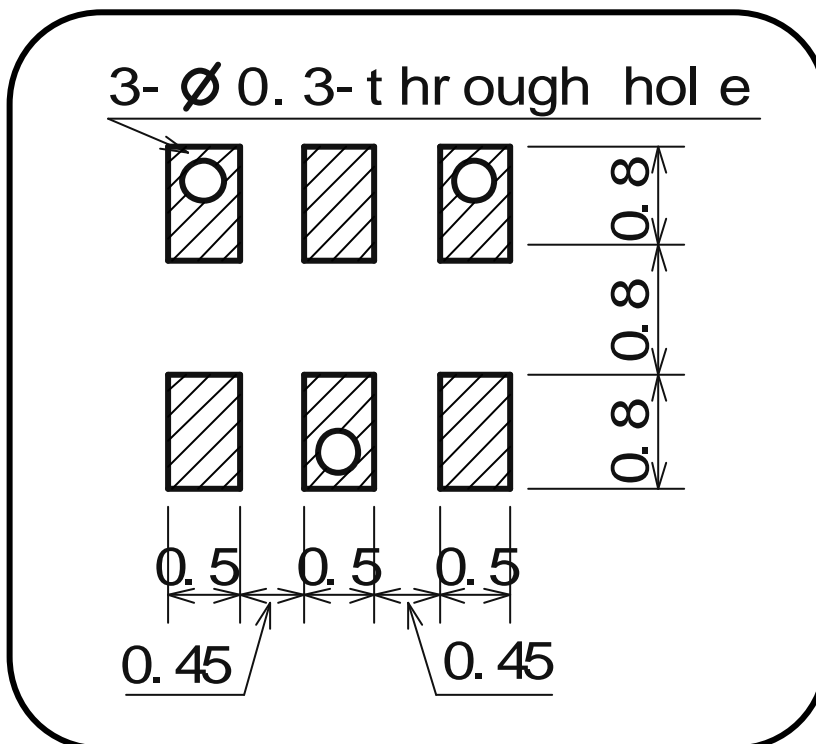

Foot Pattern

