



■ Features :

- Universal AC input / Full range
- Built-in 5V/0.3A auxiliary power
- Built-in active PFC function, PF>0.96
- Protections: Short circuit / Overload / Over voltage / Over temperature
- Forced air cooling by built-in DC fan with fan speed control
- Low profile:1U height
- Active current sharing up to 3000W (3 units)in 19" rack, 3 racks max. can be operated in parallel (up to 8 units) (Note.7)
- Remote control for single unit
- Built-in remote sense function
- Output voltage trimming function
- Hot-swap operation
- Optional I²C serial data bus
- AC OK & DC OK signal
- Internal ORing diode
- 3 years warranty

■ SELECTION GUIDE



Single Unit: RCP-1000-**12**-**C**

Rack: RCP-1U **I**

Whole System: RCP-3K1U **I**-**12**-**C**

C: With I²C Interface
-: Without I²C Interface
Output Voltage
I: AC Inlet(IEC320-C14)
T: Terminal Block

C: With I²C Interface
-: Without I²C Interface
Output Voltage
I: AC Inlet(IEC320-C14)
T: Terminal Block

SPECIFICATION - Single Unit

| MODEL | | RCP-1000-12 | RCP-1000-24 | RCP-1000-48 | |
|---------------------|------------------------------|--|--------------|--------------|-------------|
| OUTPUT | DC VOLTAGE | 12V | 24V | 48V | |
| | RATED CURRENT | 60A | 40A | 21A | |
| | CURRENT RANGE | 0 ~ 60A | 0 ~ 40A | 0 ~ 21A | |
| | RATED POWER | 720W | 960W | 1008W | |
| | RIPPLE & NOISE (max.) Note.2 | 150mVp-p | 200mVp-p | 300mVp-p | |
| | VOLTAGE ADJ. RANGE | 11.6 ~ 12.4V | 23.2 ~ 24.8V | 46.3 ~ 49.7V | |
| | VOLTAGE TOLERANCE Note.3 | ±1.0% | ±1.0% | ±1.0% | |
| | LINE REGULATION | ±0.5% | ±0.5% | ±0.5% | |
| | LOAD REGULATION | ±0.5% | ±0.5% | ±0.5% | |
| | SETUP, RISE TIME | 1000ms, 60ms/230VAC at full load | | | |
| HOLD UP TIME (Typ.) | 16ms/230VAC at full load | | | | |
| INPUT | VOLTAGE RANGE Note.5 | 90 ~ 264VAC | 127 ~ 370VDC | | |
| | FREQUENCY RANGE | 47 ~ 63Hz | | | |
| | EFFICIENCY (Typ.) | 81% | 87% | 89% | |
| | AC CURRENT (Typ.) | 8.5A/115VAC | 4.5A/230VAC | 10.5A/115VAC | 5.5A/230VAC |
| | INRUSH CURRENT (Typ.) | COLD START 50A | | | |
| LEAKAGE CURRENT | <1.1mA / 230VAC | | | | |
| PROTECTION | OVERLOAD | 105 ~ 125% rated output power Protection type : Constant current limiting, recovers automatically after fault condition is removed | | | |
| | OVER VOLTAGE | 13.2 ~ 16.2V | 26.4 ~ 32.4V | 52.8 ~ 64.8V | |
| | OVER TEMPERATURE | 75°C ±5°C (TSW1) detect on heatsink of power transistor 85°C ±5°C (TSW2) detect on heatsink of power diode Protection type : Shut down o/p voltage, recovers automatically after temperature goes down | | | |



| MODEL | | RCP-1000-12 | RCP-1000-24 | RCP-1000-48 |
|-----------------------|----------------------------|---|-------------|-------------|
| FUNCTION | AUXILIARY POWER | 5V @ 0.3A | | |
| | REMOTE ON/OFF CONTROL | By electrical signal or dry contact ON:short OFF:open | | |
| | REMOTE SENSE | Compensate voltage drop on the load wiring up to 0.5V | | |
| | DC OK SIGNAL | The TTL signal out, refer to function manual | | |
| | AC FAIL SIGNAL | The TTL signal out, refer to function manual | | |
| | OUTPUT VOLTAGE TRIM | Adjustment of output voltage, possible between 90 ~ 110% of rated output | | |
| | OVER TEMP WARNING | Logic " High" for over temperature warning, refer to function manual | | |
| ENVIRONMENT | WORKING TEMP. | -20 ~ +60°C (Refer to output load derating curve) | | |
| | WORKING HUMIDITY | 20 ~ 90% RH non-condensing | | |
| | STORAGE TEMP., HUMIDITY | -40 ~ +85°C, 10 ~ 95% RH | | |
| | TEMP. COEFFICIENT | ±0.02%/°C (0 ~ 50°C) | | |
| | VIBRATION | 10 ~ 500Hz, 2G 10min./1cycle, 60min. each along X, Y, Z axes | | |
| SAFETY & EMC (Note 4) | SAFETY STANDARDS | UL60950-1, TUV EN60950-1 approved | | |
| | WITHSTAND VOLTAGE | I/P-O/P:3KVAC I/P-FG:1.5KVAC O/P-FG:0.7KVDC | | |
| | ISOLATION RESISTANCE | I/P-O/P, I/P-FG, O/P-FG:100M Ohms / 500VDC / 25°C / 70% RH | | |
| | EMI CONDUCTION & RADIATION | Compliance to EN55022 (CISPR22) Class B | | |
| | HARMONIC CURRENT | Compliance to EN61000-3-2,-3 | | |
| | EMS IMMUNITY | Compliance to EN61000-4-2,3,4,5,6,8,11, ENV50204, EN61000-6-2 (EN50082-2), heavy industry level, criteria A | | |
| OTHERS | MTBF | 43.4Khrs min. MIL-HDBK-217F (25°C) | | |
| | DIMENSION | 295*127*41mm (L*W*H) | | |
| | PACKING | 1.91Kg; 6pcs/12.5Kg/1.04CUFT | | |

SPECIFICATION - Rack System

| MODEL | | RCP-3K1U□-12 | RCP-3K1U□-24 | RCP-3K1U□-48 |
|-----------------------|--|--|--------------------------|------------------------|
| OUTPUT | MODULE | RCP-1000-12 | RCP-1000-24 | RCP-1000-48 |
| | RACK | RCP-1UI or RCP-1UT | | |
| | OUTPUT VOLTAGE | 12V | 24V | 48V |
| | MAX. OUTPUT CURRENT | 180A | 120A | 63A |
| | MAX. OUTPUT POWER ^{Note.6} | 2160W | 2880W | 3024W |
| INPUT | VOLTAGE RANGE ^{Note.5} | 90 ~ 264VAC 127 ~ 370VDC | | |
| | FREQUENCY RANGE | 47 ~ 63Hz | | |
| | AC CURRENT (Typ.)FOR EACH UNIT | 8.5A/115VAC 4.5A/230VAC | 10.5A/115VAC 5.5A/230VAC | 11A/115VAC 5.5A/230VAC |
| | LEAKAGE CURRENT | <3.5mA / 230VAC | | |
| FUNCTION | AUXILIARY POWER | 5V @ 0.3A | | |
| | REMOTE ON/OFF CONTROL | By electrical signal or dry contact ON:short OFF:open | | |
| | REMOTE SENSE | Compensate voltage drop on the load wiring up to 0.5V. "Local Sense"should be connected in order to get the correct output voltage if the "Remote Sense" is not used | | |
| | DC OK SIGNAL | The TTL signal out, refer to function manual | | |
| | AC FAIL SIGNAL | The TTL signal out, refer to function manual | | |
| | OUTPUT VOLTAGE TRIM | Adjustment of output voltage, possible between 90 ~ 110% of rated output | | |
| | OVER TEMP WARNING | Logic " High" for over temperature warning, refer to function manual | | |
| ENVIRONMENT | WORKING TEMP. | -20 ~ +60°C (Refer to output load derating curve) | | |
| | WORKING HUMIDITY | 20 ~ 90% RH non-condensing | | |
| | STORAGE TEMP., HUMIDITY | -40 ~ +85°C, 10 ~ 95% RH | | |
| | TEMP. COEFFICIENT | ±0.02%/°C (0 ~ 50°C) | | |
| | VIBRATION | 10 ~ 500Hz, 2G 10min./1cycle, 60min. each along X, Y, Z axes | | |
| SAFETY & EMC (Note 4) | SAFETY STANDARDS | UL60950-1, TUV EN60950-1 approved | | |
| | WITHSTAND VOLTAGE | I/P-O/P:3KVAC I/P-FG:1.5KVAC O/P-FG:0.7KVDC | | |
| | ISOLATION RESISTANCE | I/P-O/P, I/P-FG, O/P-FG:100M Ohms / 500VDC / 25°C / 70% RH | | |
| | EMI CONDUCTION & RADIATION | Compliance to EN55022 (CISPR22) Class B | | |
| | HARMONIC CURRENT | Compliance to EN61000-3-2,-3 | | |
| | EMS IMMUNITY | Compliance to EN61000-4-2,3,4,5,6,8,11, ENV50204, EN61000-6-2 (EN50082-2), heavy industry level, criteria A | | |
| OTHERS | DIMENSION | Rack 483.6*350.8*44(L*W*H) | | |
| | PACKING | 11Kg; 1pcs/11Kg/2.67CUFT | | |
| NOTE | <ol style="list-style-type: none"> All parameters NOT specially mentioned are measured at 230VAC input, rated load and 25°C of ambient temperature. Ripple & noise are measured at 20MHz of bandwidth by using a 12" twisted pair-wire terminated with a 0.1uf & 47uf parallel capacitor. Tolerance : includes set up tolerance, line regulation and load regulation. The power supply is considered a component which will be installed into a final equipment. The final equipment must be re-confirmed that it still meets EMC directives. For guidance on how to perform these EMC tests, please refer to "EMI testing of component power supplies." (as available on http://www.meanwell.com) Derating may be needed under low input voltages. Please check the derating curve for more details. Output of all the RCP-1000 modules are connected in parallel in the rack. Under parallel operation of more than one rack connecting together, ripple of the output voltage may be higher than the SPEC at light load condition. It will go back to normal ripple level once the output load is more than 10%. | | | |

■ Mechanical Specification (Single Unit)

Case No. 952A Unit:mm

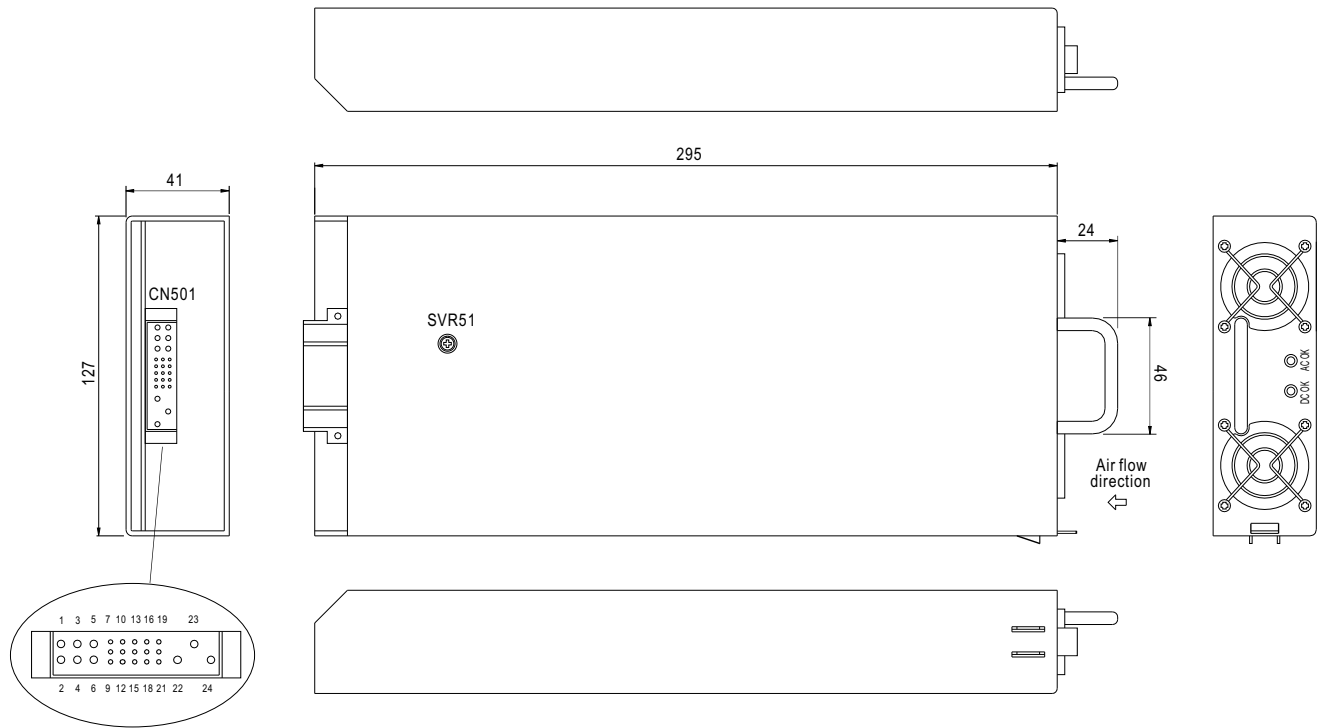

Input / Output Connector Pin No. Assignment(CN501) : Postronic PCB24W9M400A1

| Pin No. | Assignment | Pin No. | Assignment | Pin No. | Assignment | Pin No. | Assignment | Mating Housing |
|---------|------------|---------|------------|---------|------------|---------|------------|----------------------------|
| 1,2,4 | +V | 10 | AC_OK | 15 | +5V_AUX | 20 | A1 | Postronic PCB24W9F400A1 |
| 3,5,6 | -V | 11 | DC_OK | 16 | GND_AUX | 21 | A2 | |
| 7 | ON/OFF | 12 | CS | 17 | SDA | 22 | FG | |
| 8 | +S | 13 | V_TRIM | 18 | SCL | 23 | AC/L | |
| 9 | -S | 14 | T_ALARM | 19 | A0 | 24 | AC/N | |

■ Block Diagram

PFC fosc : 110KHz
PWM fosc : 90KHz

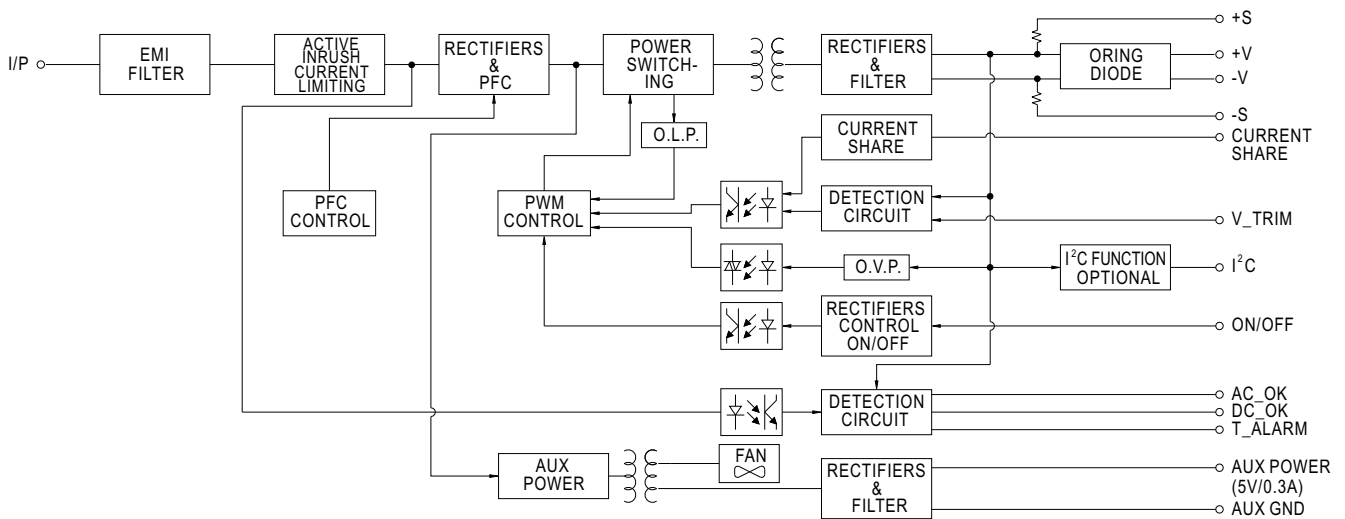

■ Mechanical Specification (Rack System)

Case No. 959A Unit:mm

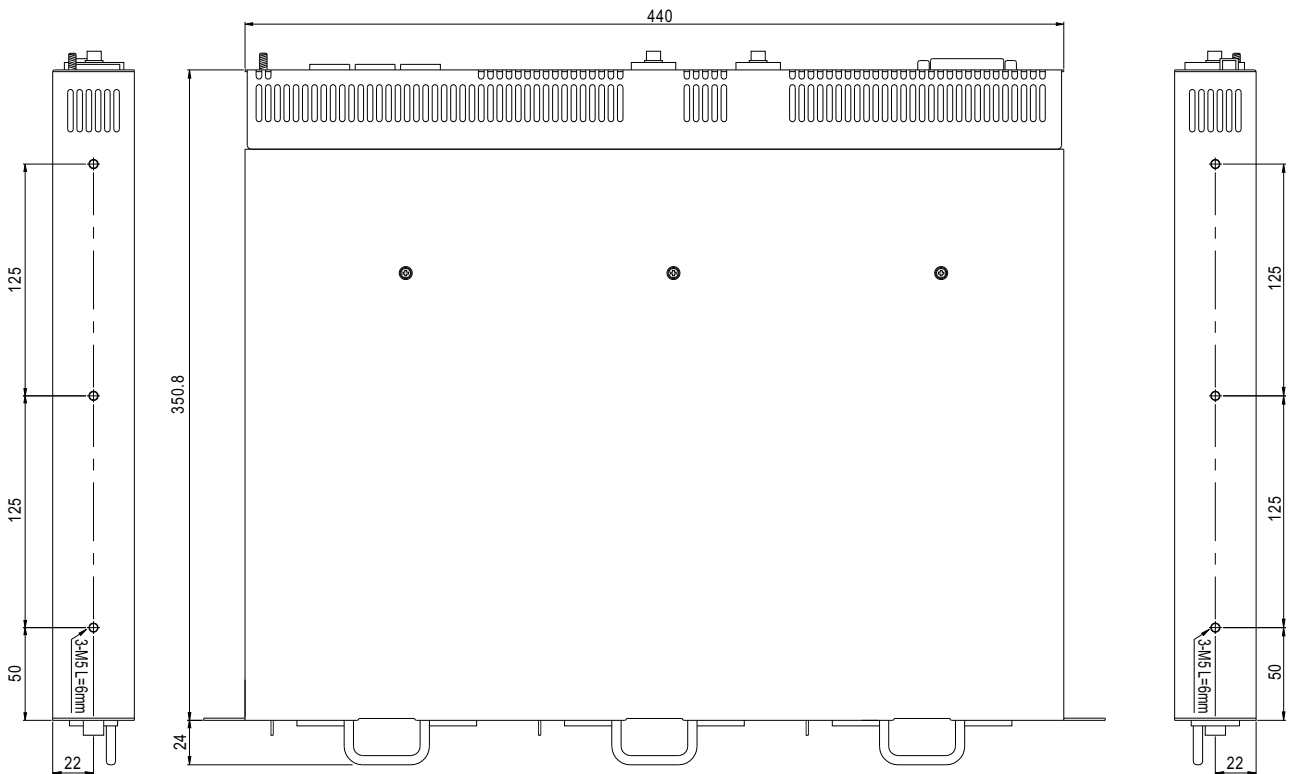
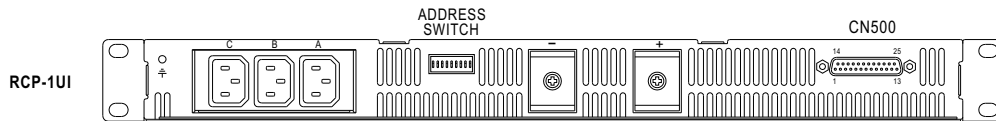
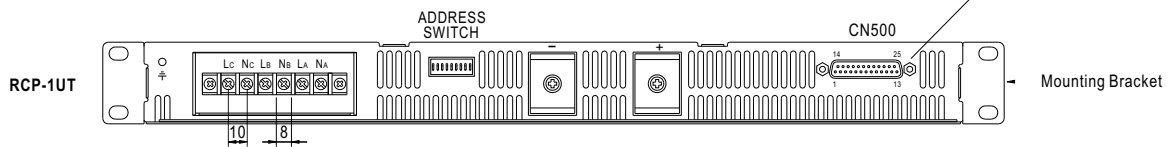
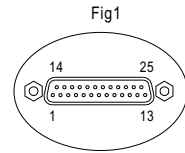
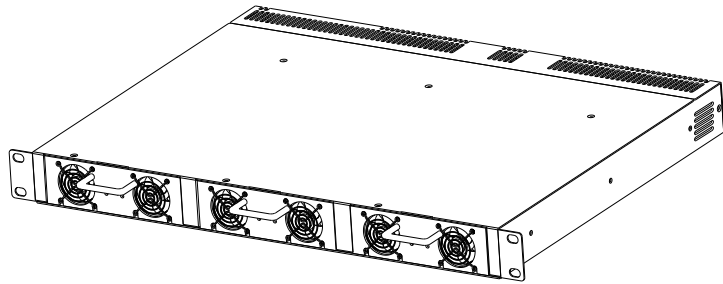

↑ Air flow direction

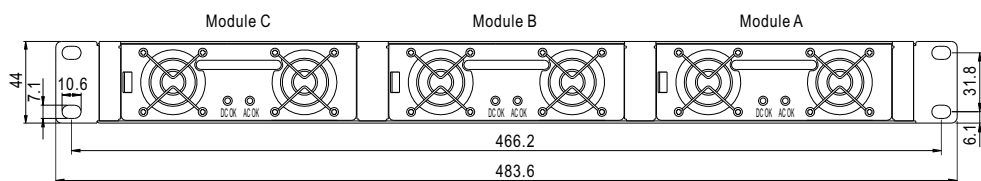

■ CN500 Pin No. Assignment

Connector Pin No. Assignment(CN500) : D-Type Right Angle 25 positions

| Pin No. | Assignment | Pin No. | Assignment | Pin No. | Assignment | Pin No. | Assignment | Pin No. | Assignment |
|---------|------------|---------|------------|---------|------------|---------|------------|---------|------------|
| 1 | ON/OFF-A | 6 | +5V-AUX | 11 | V-TRIM-B | 16 | AC-OK-C | 21 | -S |
| 2 | AC-OK-A | 7 | GND-AUX | 12 | T-ALARM-B | 17 | DC-OK-C | 22 | +V |
| 3 | DC-OK-A | 8 | ON/OFF-B | 13 | NC | 18 | V-TRIM-C | 23 | SCL |
| 4 | V-TRIM-A | 9 | AC-OK-B | 14 | CS | 19 | T-ALARM-C | 24 | SDA |
| 5 | T-ALARM-A | 10 | DC-OK-B | 15 | ON/OFF-C | 20 | +S | 25 | -V |

■ CN500 IN/OUT Connector pins function description

| Pin No. | Function | Description |
|-----------|----------|---|
| 1, 8, 15 | ON/OFF | Each unit can separately turn the output on and off by electrical or dry contact between ON/OFF A,B,C(pin 1,8,15) and -S(pin 21). Short: ON, Open:OFF. |
| 2, 9, 16 | AC-OK | Low : When the input voltage is $\geq 82V_{rms} \pm 4V$. High : when the input voltage in $\leq 82V_{rms} \pm 4V$. |
| 3, 10, 17 | DC-OK | High : When the Vout $\leq 80\% \pm 5\%$. Low : When Vout $\geq 80\% \pm 5\%$ |
| 4, 11, 18 | V-TRIM | Connection for output voltage trimming. The voltage can be trimmed within its defined range. |
| 5, 12, 19 | T-ALARM | High : When the internal temperature is within safe limit. Low : 10°C below the thermal shut down limit. |
| 6 | +5V-AUX | Auxiliary voltage output, 4.3~5.3V, referenced to GND-AUX(pin 7). The maximum load current is 0.3A. This output has the built-in "Oring diodes" and is not controlled by the remote ON/OFF control. |
| 7 | GND-AUX | Auxiliary voltage output GND. The signal return is isolated from the output terminals (+V & -V). |
| 14 | CS | Current sharing signal. When units are connected in parallel, the CS pins of the units should be connected to allow current balance between units. |
| 20 | +S | Positive sensing. The +S signal should be connected to the positive terminal of the load. The +S and -S leads should be twisted in pair to minimize noise pick-up effect. The maximum line drop compensation is 0.5V. |
| 21 | -S | Negative sensing. The -S signal should be connected to the negative terminal of the load. The -S and +S leads should be twisted in pair to minimize noise pick-up effect. The maximum line drop compensation is 0.5V. |
| 22 | +V | Positive output voltage. For local sense use only, can't be connected directly to the load. |
| 23 | SCL | Serial clock used in the I ² C interface option. Refer to the I ² C interface description. |
| 24 | SDA | Serial data used in the I ² C interface option. Refer to the I ² C interface description. |
| 25 | -V | Negative output voltage. For local sense use only, can't be connected directly to the load. |

■ Derating Curve

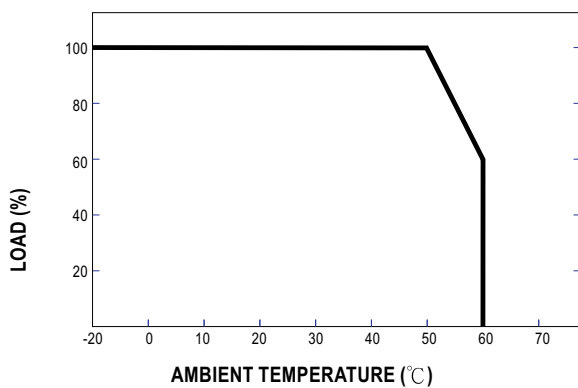

■ Static Characteristics

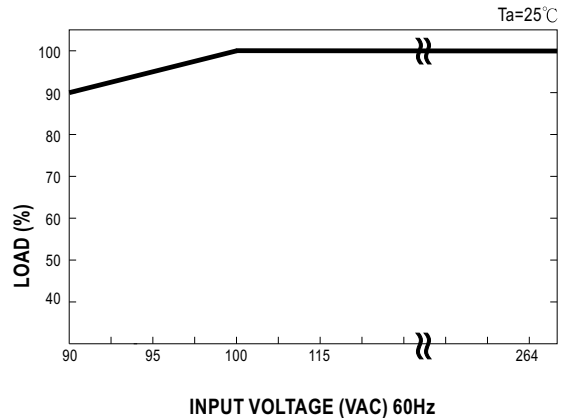

Function Manual

1. Remote ON/OFF Control

The PSU can be turned ON/OFF together or separately by using the "Remote ON/OFF" function.

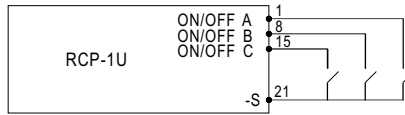
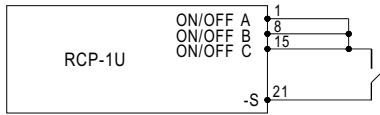

| Between ON/OFF and -S | Output |
|-----------------------|--------|
| SW Open | OFF |
| SW Short | ON |

2. Voltage Drop Compensation

2.1 Remote Sense

The remote sense compensates voltage drop on the load wiring up to 0.5V.

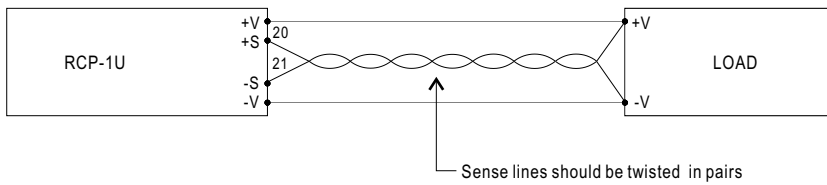

2.2 Local Sense

Notice : The +S,-S have to be connected to the +V,-V terminals locally in order to get the correct output voltage if the remote sensing is not used.



3. Output Voltage Trimming

Output voltage can be trimmed between 90~110% of its rated value by the following method.

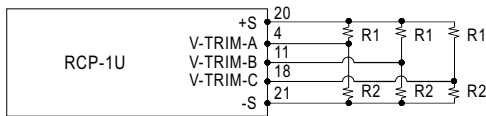

3.1 RCP-1000-12

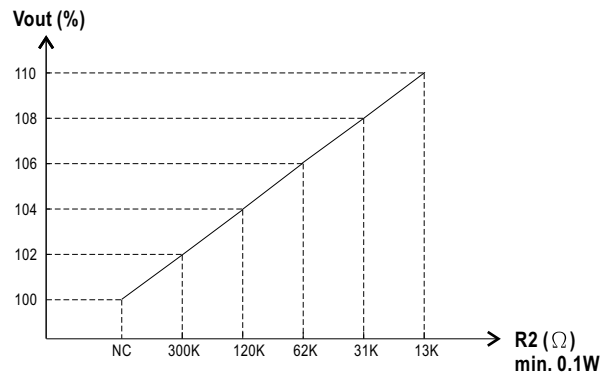
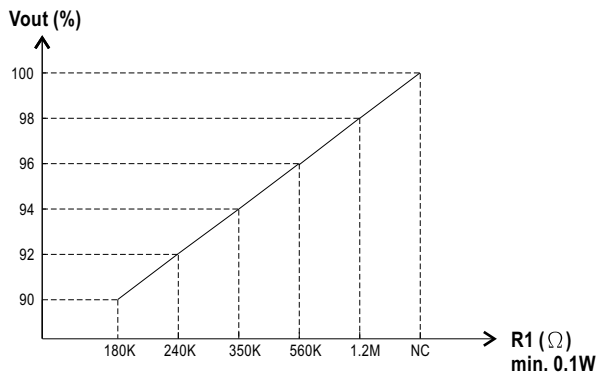

3.2 RCP-1000-24

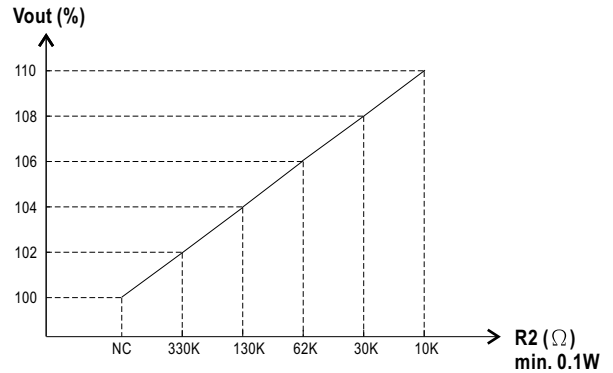
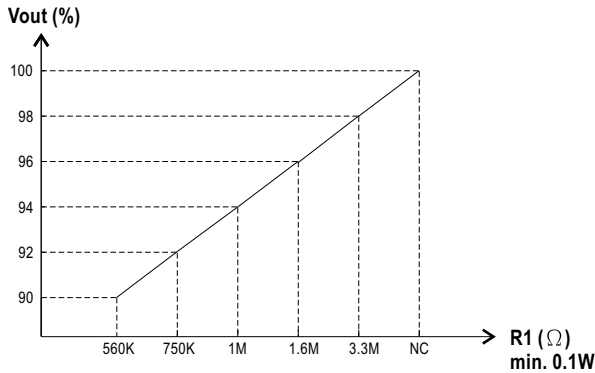

3.3 RCP-1000-48

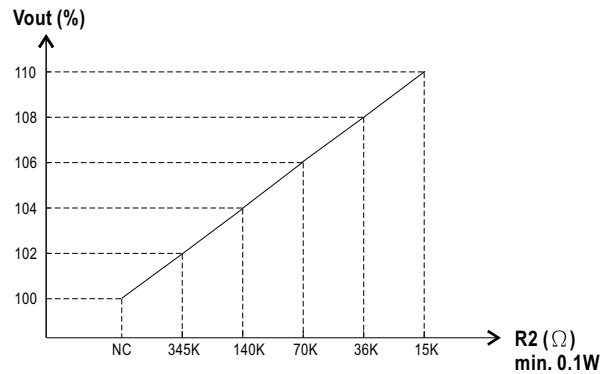
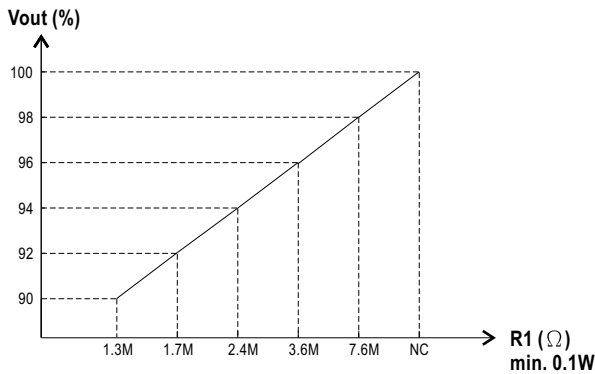

4. Front Panel Indicators & Corresponding Signal at Function Pins

| Function | LED | Description | * Signal | PSU Output |
|----------|------|--|------------|------------|
| AC-OK | ON | When input voltage $\geq 82V \pm 4V$ | 0 ~ 0.5V | ON |
| AC-NG | OFF | When input voltage $\leq 82V \pm 4V$ | 4.5 ~ 5.5V | OFF |
| DC-OK | ON | When output voltage $\geq 80\% \pm 5\%$ of Vo rated. | 0 ~ 0.5V | ON |
| DC-NG | OFF | When output voltage $\leq 80\% \pm 5\%$ of Vo rated. | 4.5 ~ 5.5V | ON |
| T-OK | ---- | When the internal temperature (TSW1 & TSW2 short) is within safe limit | 0 ~ 0.5V | ON |
| T-ALARM | ---- | When the internal temperature (TSW1 or TSW2 open) exceeds the limit of temperature alarm | 4.5 ~ 5.5V | OFF |

*Signal between function pin and "-S".

5. I²C Bus Interface Option

5.1 Addressing(A0,A1,A2)

The DIP switch down position is logic level "1" and the up position is level "0". Address are applicable when modules RCP-1000 I²C function are used.

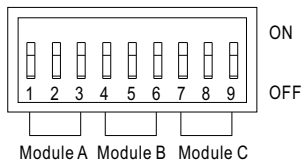

Address dip switch setting

| A2 | A1 | A0 | Module |
|----|----|----|--------|
| 3 | 2 | 1 | A |
| 6 | 5 | 4 | B |
| 9 | 8 | 7 | C |

5.2 Digital Function (Read Only)

Digital function are provided by a PCF8574 8-bit I/O port device. When this device is read by the I²C bus controller, a single 8-bit word provides the following information.

| BIT | FUNCTION | GOOD STATE | FAIL STATE | MEANING |
|-----|-----------------------------|------------|------------|--|
| 0 | AC Input Fail | 0 | 1 | Input power fail |
| 1 | Output Power Good / Fail | 0 | 1 | Output voltage is less than specification |
| 2 | Temperature Warning | 0 | 1 | Internal temperature is over 60°C. PSU turns on |
| 3 | Over Temperature Protection | 0 | 1 | Temperature exceeds nominal operating limit. PSU turns off |
| 4 | Fan Fail Warning | 0 | 1 | Failure of an internal fan |
| 5 | Not Used | ----- | ----- | Not used |
| 6 | Not Used | ----- | ----- | Not used |
| 7 | Not Used | ----- | ----- | Not used |

PCF8574 slave address

| Bit | 7 | 6 | 5 | 4 | 3 | 2 | 1 | 0 |
|-------|---|---|---|---|----|----|----|-----|
| Value | 0 | 1 | 0 | 0 | A2 | A1 | A0 | R/W |

Read : 1
Write : 0

6. Analog Function (Read Only)

6.1 Analog function are provided by a single PCF8591 4-channel 8-bit A/D converter. When this device is read by the I²C bus controller, it provides an 8-bit word with the following information:

| A/D Channel | FUNCTION |
|-------------|----------------------|
| 1 | Output Voltage |
| 2 | Output Current |
| 3 | Internal Temperature |
| 4 | Not Used |

PCF8591 slave address

| Bit | 7 | 6 | 5 | 4 | 3 | 2 | 1 | 0 |
|-------|---|---|---|---|----|----|----|-----|
| Value | 1 | 0 | 0 | 1 | A2 | A1 | A0 | R/W |

PCF8591 control byte

| Bit | 7 | 6 | 5 | 4 | 3 | 2 | 1 | 0 |
|-------|---|---|---|---|---|---|---|---|
| Value | 0 | 0 | 0 | 0 | 0 | 0 | | |

0 0 : Output Voltage
0 1 : Output Current
1 0 : Internal Temperature

6.2 A/D scaling

The voltage reading is made inside the power supply unit before the "Oring diode" and is typically 0.5V higher than the actual output voltage. The following table for the scaling should be employed:

VALUE = BYTE VALUE x RESOLUTION

| Output Voltage | Range | Scaling | Tolerance | |
|----------------|---------|-------------|-----------|------------------------------|
| 12V | 0~16V | 0.0625V/Bit | ±5% | A/D Channel 1 Voltage |
| 24V | 0~33V | 0.129V/Bit | +3%,-5% | |
| 48V | 0~65V | 0.254V/Bit | +2%,-5% | |
| 12V | 0~80A | 0.312A/Bit | ±10% | A/D Channel 2 Current |
| 24V | 0~55A | 0.215A/Bit | ±10% | |
| 48V | 0~30A | 0.117A/Bit | ±10% | |
| 12V | 0~100°C | 0.391°C/Bit | ±3°C | A/D Channel 3 Temperature |
| 24V | 0~100°C | 0.391°C/Bit | ±3°C | |
| 48V | 0~100°C | 0.391°C/Bit | ±3°C | |

7.EEPROM Function (Read Only)

The EEPROM is a 2048 bit (256 byte) device which is preprogrammed at the factory with the following data :

| Address | Bytes | Data |
|---------|-------|-----------------------|
| 4 | 16 | Manufacturer |
| 20 | 20 | Serial Number |
| 40 | 16 | Revision |
| 56 | 16 | Country of production |
| 72 | 16 | Model Name |
| 88 | 16 | Output Voltage |
| 104 | 16 | Date of production |
| 254 | 2 | Check Sum |

EEPROM slave address

| Bit | 7 | 6 | 5 | 4 | 3 | 2 | 1 | 0 |
|-------|---|---|---|---|----|----|----|-----|
| Value | 1 | 0 | 1 | 0 | A2 | A1 | A0 | R/W |