

IS61SP6436

64K x 36 SYNCHRONOUS PIPELINED STATIC RAM

ADVANCE INFORMATION
SEPTEMBER 1997

FEATURES

- Internal self-timed write cycle
- Individual Byte Write Control and Global Write
- Clock controlled, registered address, data and control
- Pentium™ or linear burst sequence control using MODE input
- Three chip enables for simple depth expansion and address pipelining
- Common data inputs and data outputs
- Power-down control by ZZ input
- JEDEC 100-Pin TQFP and PQFP package
- Single +3.3V power supply
- Two Clock enables and one Clock disable to eliminate multiple bank bus contention.
- Control pins mode upon power-up:
 - MODE in interleave burst mode
 - ZZ in normal operation mode
 These control pins can be connected to GNDQ or VCCQ to alter their power-up state

DESCRIPTION

The *ISSI* IS61SP6436 is a high-speed, low-power synchronous static RAM designed to provide a burstable, high-performance, secondary cache for the i486™, Pentium™, 680X0™, and PowerPC™ microprocessors. It is organized as 65,536 words by 36 bits, fabricated with *ISSI*'s advanced CMOS technology. The device integrates a 2-bit burst counter, high-speed SRAM core, and high-drive capability outputs into a single monolithic circuit. All synchronous inputs pass through registers controlled by a positive-edge-triggered single clock input.

Write cycles are internally self-timed and are initiated by the rising edge of the clock input. Write cycles can be from one to four bytes wide as controlled by the write control inputs.

Separate byte enables allow individual bytes to be written. $\overline{BW1}$ controls DQP1 and DQ1-DQ8, $\overline{BW2}$ controls DQP2 and DQ9-DQ16, $\overline{BW3}$ controls DQP3 and DQ17-DQ24, $\overline{BW4}$ controls DQP4 and DQ25-DQ32, conditioned by \overline{BWE} being LOW. A LOW on \overline{GW} input would cause all bytes to be written.

Bursts can be initiated with either \overline{ADSP} (Address Status Processor) or \overline{ADSC} (Address Status Cache Controller) input pins. Subsequent burst addresses can be generated internally by the IS61SP6436 and controlled by the \overline{ADV} (burst address advance) input pin.

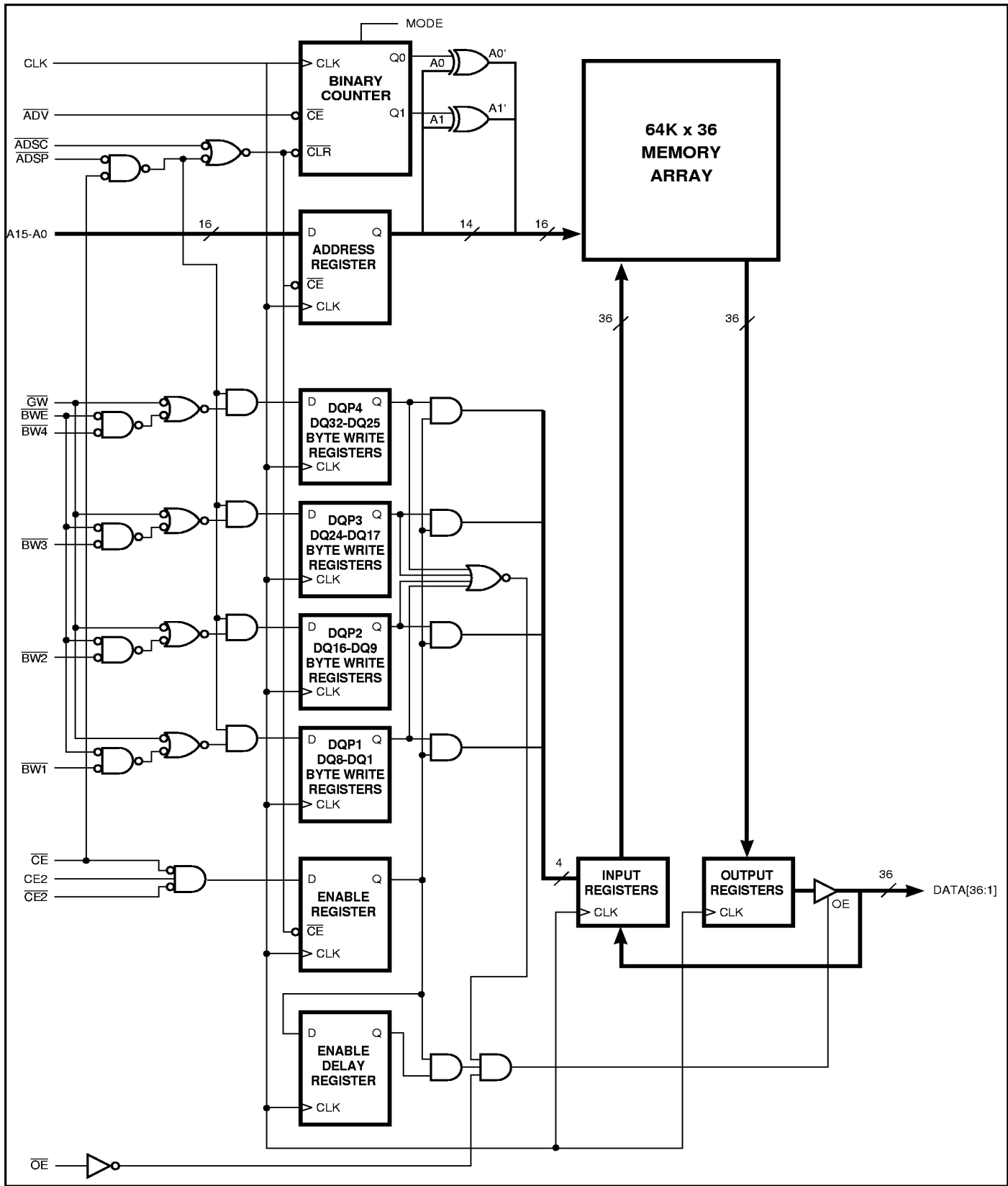
Asynchronous signals include output enable (\overline{OE}), sleep mode input (ZZ), clock (CLK) and burst mode input (MODE). A HIGH input on the ZZ pin puts the SRAM in the power-down state. When ZZ is pulled LOW (or no connect), the SRAM normally operates after three cycles of the wake-up period. A LOW input, i.e., GNDQ, on MODE pin selects LINEAR Burst. A VCCQ (or no connect) on MODE pin selects INTERLEAVED Burst.

FAST ACCESS TIME

Symbol	Parameter	-4.5	-4.8	-5	-6	-7	-8	Unit
t _{KQ}	Clock Access Time	5	5	5	6	7	8	ns
t _{KC}	Cycle Time	7.5	8.5	10	12	13	15	ns
	Frequency	133	117	100	83	75	66	MHz

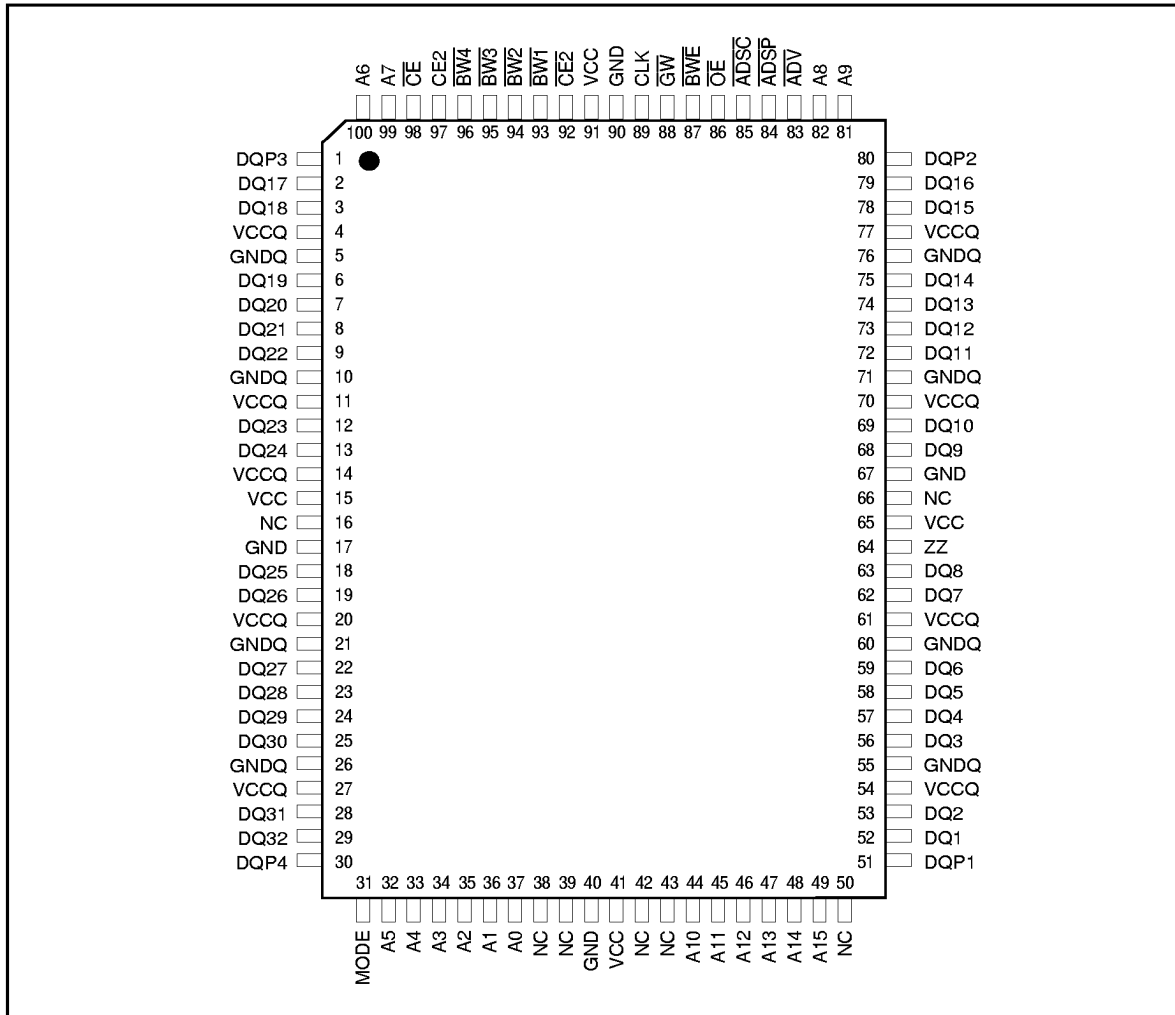
This document contains ADVANCE INFORMATION data. *ISSI* reserves the right to make changes to its products at any time without notice in order to improve design and supply the best possible product. We assume no responsibility for any errors which may appear in this publication. © Copyright 1997, Integrated Silicon Solution, Inc.

BLOCK DIAGRAM



PIN CONFIGURATION

100-Pin TQFP and PQFP (Top View)



PIN DESCRIPTIONS

A0-A15	Address Inputs	DQ1-DQ32	Data Input/Output
CLK	Clock	DQP1-DQP4	Parity Inputs/Outputs
$\overline{\text{ADSP}}$	Processor Address Status	ZZ	Sleep Mode
$\overline{\text{ADSC}}$	Controller Address Status	MODE	Burst Sequence Mode
$\overline{\text{ADV}}$	Burst Address Advance	Vcc	+3.3V Power Supply
$\overline{\text{BW1-BW4}}$	Synchronous Byte Write Enable	GND	Ground
$\overline{\text{BWE}}$	Byte Write Enable	Vccq	Isolated Output Buffer Supply: +3.3V
$\overline{\text{GW}}$	Global Write Enable	GNDq	Isolated Output Buffer Ground
$\overline{\text{CE}}, \overline{\text{CE2}}, \overline{\text{CE2}}$	Synchronous Chip Enable		
$\overline{\text{OE}}$	Output Enable		

TRUTH TABLE

OPERATION	ADDRESS USED	\overline{CE}	$\overline{CE2}$	CE2	\overline{ADSP}	\overline{ADSC}	\overline{ADV}	WRITE	\overline{OE}	DQ
Deselected, Power-down	None	H	X	X	X	L	X	X	X	High-Z
Deselected, Power-down	None	L	X	L	L	X	X	X	X	High-Z
Deselected, Power-down	None	L	H	X	L	X	X	X	X	High-Z
Deselected, Power-down	None	L	X	L	H	L	X	X	X	High-Z
Deselected, Power-down	None	L	H	X	H	L	X	X	X	High-Z
Read Cycle, Begin Burst	External	L	L	H	L	X	X	X	L	Q
Read Cycle, Begin Burst	External	L	L	H	L	X	X	X	H	High-Z
Write Cycle, Begin Burst	External	L	L	H	H	L	X	L	X	D
Read Cycle, Begin Burst	External	L	L	H	H	L	X	H	L	Q
Read Cycle, Begin Burst	External	L	L	H	H	L	X	H	H	High-Z
Read Cycle, Continue Burst	Next	X	X	X	H	H	L	H	L	Q
Read Cycle, Continue Burst	Next	X	X	X	H	H	L	H	H	High-Z
Read Cycle, Continue Burst	Next	H	X	X	X	H	L	H	L	Q
Read Cycle, Continue Burst	Next	H	X	X	X	H	L	H	H	High-Z
Write Cycle, Continue Burst	Next	X	X	X	H	H	L	L	X	D
Write Cycle, Continue Burst	Next	H	X	X	X	H	L	L	X	D
Read Cycle, Suspend Burst	Current	X	X	X	H	H	H	H	L	Q
Read Cycle, Suspend Burst	Current	X	X	X	H	H	H	H	H	High-Z
Read Cycle, Suspend Burst	Current	H	X	X	X	H	H	H	L	Q
Read Cycle, Suspend Burst	Current	H	X	X	X	H	H	H	H	High-Z
Write Cycle, Suspend Burst	Current	X	X	X	H	H	H	L	X	D
Write Cycle, Suspend Burst	Current	H	X	X	X	H	H	L	X	D

Notes:

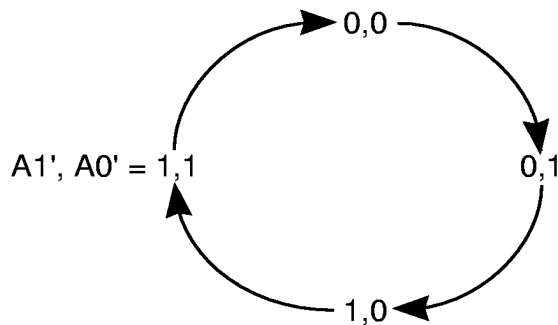
- All inputs except \overline{OE} must meet setup and hold times for the Low-to-High transition of clock (CLK).
- Wait states are inserted by suspending burst.
- X means don't care. $\overline{WRITE}=L$ means any one or more byte write enable signals ($\overline{BW1}$ - $\overline{BW4}$) and \overline{BWE} are LOW or \overline{GW} is LOW. $\overline{WRITE}=H$ means all byte write enable signals are HIGH.
- For a Write operation following a Read operation, \overline{OE} must be HIGH before the input data required setup time and held HIGH throughout the input data hold time.
- \overline{ADSP} LOW always initiates an internal READ at the Low-to-High edge of clock. A WRITE is performed by setting one or more byte write enable signals and \overline{BWE} LOW or \overline{GW} LOW for the subsequent L-H edge of clock.

PARTIAL TRUTH TABLE

FUNCTION	\overline{GW}	\overline{BWE}	$\overline{BW1}$	$\overline{BW2}$	$\overline{BW3}$	$\overline{BW4}$
READ	H	H	X	X	X	X
READ	H	L	H	H	H	H
WRITE Byte 1	H	L	L	H	H	H
WRITE All Bytes	H	L	L	L	L	L
WRITE All Bytes	L	X	X	X	X	X

INTERLEAVED BURST ADDRESS TABLE (MODE = V_{CCQ} or No Connect)

External Address A1 A0	1st Burst Address A1 A0	2nd Burst Address A1 A0	3rd Burst Address A1 A0
00	01	10	11
01	00	11	10
10	11	00	01
11	10	01	00

LINEAR BURST ADDRESS TABLE (MODE = GND_Q)**ABSOLUTE MAXIMUM RATINGS⁽¹⁾**

Symbol	Parameter	Value	Unit
T _{BIAS}	Temperature Under Bias	-10 to +85	°C
T _{STG}	Storage Temperature	-55 to +150	°C
P _D	Power Dissipation	1.8	W
I _{OUT}	Output Current (per I/O)	100	mA
V _{IN} , V _{OUT}	Voltage Relative to GND for I/O Pins	-0.5 to V _{CCQ} + 0.3	V
V _{IN}	Voltage Relative to GND for for Address and Control Inputs	-0.5 to 5.5	V
V _{CC}	Voltage on V _{CC} Supply Relative to GND	-0.5 to 4.6	V

Notes:

1. Stress greater than those listed under ABSOLUTE MAXIMUM RATINGS may cause permanent damage to the device. This is a stress rating only and functional operation of the device at these or any other conditions above those indicated in the operational sections of this specification is not implied. Exposure to absolute maximum rating conditions for extended periods may affect reliability.
2. This device contains circuitry to protect the inputs against damage due to high static voltages or electric fields; however, precautions may be taken to avoid application of any voltage higher than maximum rated voltages to this high-impedance circuit.
3. This device contains circuitry that will ensure the output devices are in High-Z at power up.

OPERATING RANGE

Range	Ambient Temperature	V _{CC}
Commercial	0°C to +70°C	3.3V +10%, -5%
Industrial	-40°C to +85°C	3.3V +10%, -5%

DC ELECTRICAL CHARACTERISTICS⁽¹⁾ (Over Operating Range)

Symbol	Parameter	Test Conditions	Min.	Max.	Unit
V _{OH}	Output HIGH Voltage	I _{OH} = -5.0 mA	2.4	—	V
V _{OL}	Output LOW Voltage	I _{OL} = 5.0 mA	—	0.4	V
V _{IH}	Input HIGH Voltage		2.0	V _{CCQ} + 0.3	V
V _{IL}	Input LOW Voltage		-0.3	0.8	V
I _{LI}	Input Leakage Current	GND ≤ V _{IN} ≤ V _{CCQ} ⁽²⁾	Com. Ind.	-5 5 -10 10	μA
I _{LO}	Output Leakage Current	GND ≤ V _{OUT} ≤ V _{CCQ} , $\overline{OE} = V_{IH}$	Com. Ind.	-5 5 -10 10	μA

POWER SUPPLY CHARACTERISTICS (Over Operating Range)

Symbol	Parameter	Test Conditions		-4.5		-4.8		-5		-6		-7		-8		Unit
				Typ.	Max.	Typ.	Max.	Typ.	Max.	Typ.	Max.	Typ.	Max.			
I _{CC}	AC Operating Supply Current	Device Selected, All Inputs = V _{IL} or V _{IH} $\overline{OE} = V_{IH}$, Cycle Time ≥ t _{kc} min.	Com.	230	260	220	250	200	230	190	220	180	210	170	200	mA
			Ind.	—	—	230	260	220	250	200	230	190	220	180	210	mA
I _{SB}	Standby Current	Device Deselected, V _{CC} = Max., All Inputs = V _{IH} or V _{IL} CLK Cycle Time ≥ t _{kc} min.	Com.	45	70	45	70	45	70	45	70	45	70	45	65	mA
			Ind.	—	—	50	75	50	75	50	75	50	75	50	70	mA
I _{ZZ}	Power-Down Mode Current	ZZ = V _{CCQ} , CLK Running All Inputs ≤ GND + 0.2V or ≥ V _{CC} - 0.2V	Com.	1	10	1	10	1	10	1	10	1	10	1	10	mA
			Ind.	—	—	2	20	2	20	2	20	2	20	2	20	mA

Note:

- The MODE pin has an internal pullup. ZZ pin has an internal pull-down. This pin may be a No Connect, tied to GND, or tied to V_{CCQ}.
- The MODE pin should be tied to V_{CC} or GND. It exhibits ±10 μA maximum leakage current when tied to ≤ GND + 0.2V or ≥ V_{CC} - 0.2V.

CAPACITANCE^(1,2)

Symbol	Parameter	Conditions	Max.	Unit
C_{IN}	Input Capacitance	$V_{IN} = 0V$	6	pF
C_{OUT}	Input/Output Capacitance	$V_{OUT} = 0V$	8	pF

Notes:

1. Tested initially and after any design or process changes that may affect these parameters.
2. Test conditions: $T_A = 25^\circ C$, $f = 1\text{ MHz}$, $V_{CC} = 3.3V$.

AC TEST CONDITIONS

Parameter	Unit
Input Pulse Level	0V to 3.0V
Input Rise and Fall Times	1.5 ns
Input and Output Timing and Reference Level	1.5V
Output Load	See Figures 1 and 2

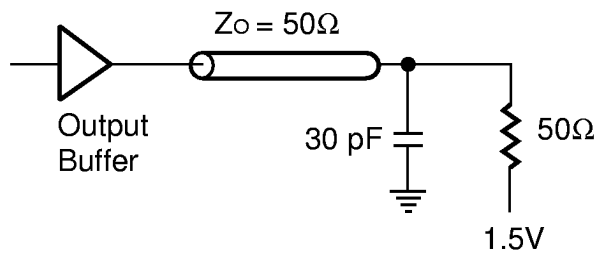
AC TEST LOADS

Figure 1

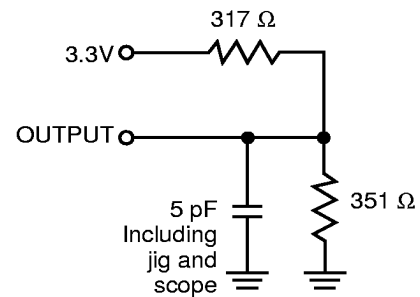


Figure 2

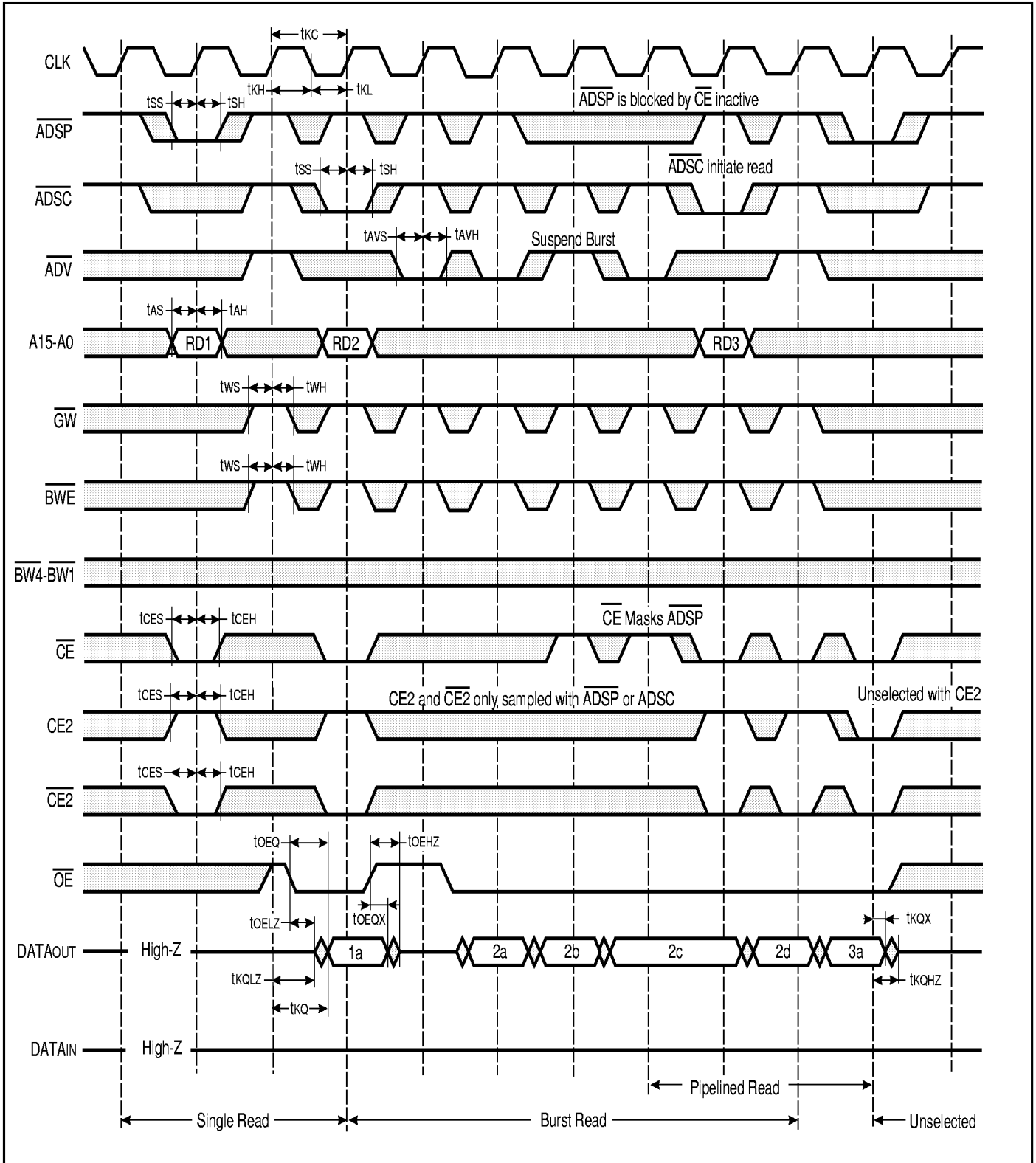
READ CYCLE SWITCHING CHARACTERISTICS (Over Operating Range)

Symbol	Parameter	-4.5	-4.8	-5	-6	-7	-8	Unit
		Min.Max.	Min.Max.	Min.Max.	Min.Max.	Min.Max.	Min.Max.	
t _{CC}	Cycle Time	7.5 —	8.5 —	10 —	12 —	13 —	15 —	ns
t _{KH}	Clock High Time	1.9 —	2.5 —	3.2 —	4 —	4.5 —	5 —	ns
t _{KL}	Clock Low Time	1.9 —	2.5 —	3.2 —	4 —	4.5 —	5 —	ns
t _{KQ}	Clock Access Time	— 5	— 5	— 5	— 6	— 7	— 8	ns
t _{KQX} ⁽¹⁾	Clock High to Output Invalid	1.5 —	1.5 —	1.5 —	1.5 —	2 —	2 —	ns
t _{KQLZ} ⁽¹⁾	Clock High to Output Low-Z	0 —	0 —	0 —	0 —	0 —	0 —	ns
t _{KQHZ} ⁽¹⁾	Clock High to Output High-Z	1.5 5	1.5 6	1.5 6	1.5 6	2 6	2 6	ns
t _{OEQ}	Output Enable to Output Valid	— 5	— 5	— 5	— 5	— 5	— 5	ns
t _{OEQX} ⁽¹⁾	Output Disable to Output Invalid	0 —	0 —	0 —	0 —	0 —	0 —	ns
t _{OELZ} ⁽¹⁾	Output Enable to Output Low-Z	0 —	0 —	0 —	0 —	0 —	0 —	ns
t _{OEHZ} ⁽¹⁾	Output Disable to Output High-Z	— 3	— 4	— 5	— 5	— 5	— 6	ns
t _{AS}	Address Setup Time	2.5 —	2.5 —	2.5 —	2.5 —	2.5 —	2.5 —	ns
t _{SS}	Address Status Setup Time	2.5 —	2.5 —	2.5 —	2.5 —	2.5 —	2.5 —	ns
t _{WS}	Write Setup Time	2.5 —	2.5 —	2.5 —	2.5 —	2.5 —	2.5 —	ns
t _{CEs}	Chip Enable Setup Time	2.5 —	2.5 —	2.5 —	2.5 —	2.5 —	2.5 —	ns
t _{AVS}	Address Advance Setup Time	2.5 —	2.5 —	2.5 —	2.5 —	2.5 —	2.5 —	ns
t _{AH}	Address Hold Time	0.5 —	0.5 —	0.5 —	0.5 —	0.5 —	0.5 —	ns
t _{SH}	Address Status Hold Time	0.5 —	0.5 —	0.5 —	0.5 —	0.5 —	0.5 —	ns
t _{WH}	Write Hold Time	0.5 —	0.5 —	0.5 —	0.5 —	0.5 —	0.5 —	ns
t _{CEH}	Chip Enable Hold Time	0.5 —	0.5 —	0.5 —	0.5 —	0.5 —	0.5 —	ns
t _{AVH}	Address Advance Hold Time	0.5 —	0.5 —	0.5 —	0.5 —	0.5 —	0.5 —	ns
t _{CFG}	Configuration Setup ⁽²⁾	30 —	35 —	35 —	45 —	66.7 —	80 —	ns

Note:

1. Guaranteed but not 100% tested. This parameter is periodically sampled.
2. Configuration Setup Mode is static and must not change during normal operation.

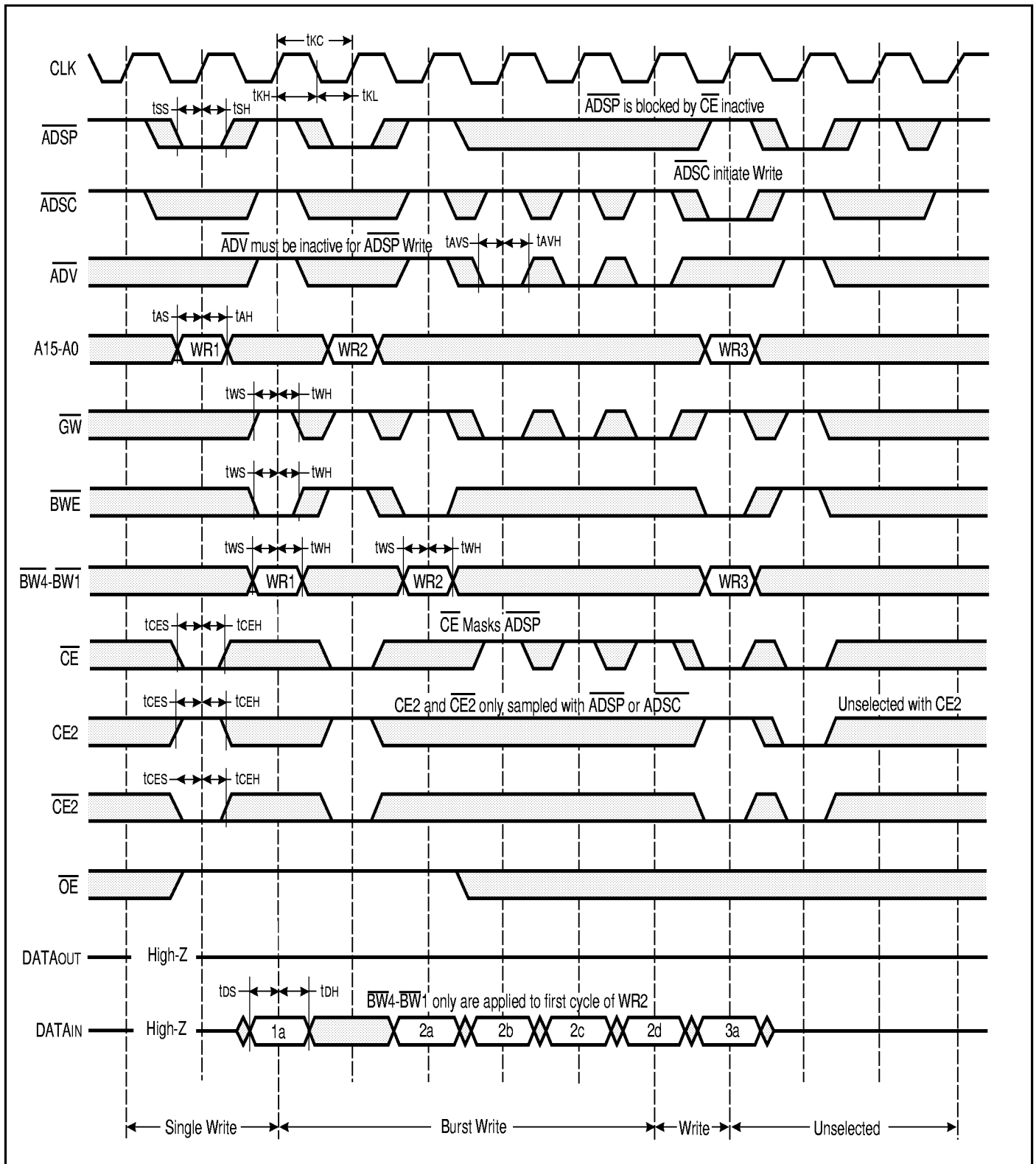
READ CYCLE TIMING



WRITE CYCLE SWITCHING CHARACTERISTICS (Over Operating Range)

Symbol	Parameter	-4.5		-4.8		-5		-6		-7		-8		Unit
		Min.	Max.	Min.	Max.	Min.	Max.	Min.	Max.	Min.	Max.	Min.	Max.	
t _{CC}	Cycle Time	7.5	—	8.5	—	10	—	12	—	13	—	15	—	ns
t _{KH}	Clock High Time	1.9	—	2.5	—	3.2	—	4	—	4.5	—	5	—	ns
t _{KL}	Clock Low Time	1.9	—	2.5	—	3.2	—	4	—	4.5	—	5	—	ns
t _{AS}	Address Setup Time	2.5	—	2.5	—	2.5	—	2.5	—	2.5	—	2.5	—	ns
t _{SS}	Address Status Setup Time	2.5	—	2.5	—	2.5	—	2.5	—	2.5	—	2.5	—	ns
t _{WS}	Write Setup Time	2.5	—	2.5	—	2.5	—	2.5	—	2.5	—	2.5	—	ns
t _{DS}	Data In Setup Time	2.5	—	2.5	—	2.5	—	2.5	—	2.5	—	2.5	—	ns
t _{CEs}	Chip Enable Setup Time	2.5	—	2.5	—	2.5	—	2.5	—	2.5	—	2.5	—	ns
t _{AVS}	Address Advance Setup Time	2.5	—	2.5	—	2.5	—	2.5	—	2.5	—	2.5	—	ns
t _{AH}	Address Hold Time	0.5	—	0.5	—	0.5	—	0.5	—	0.5	—	0.5	—	ns
t _{SH}	Address Status Hold Time	0.5	—	0.5	—	0.5	—	0.5	—	0.5	—	0.5	—	ns
t _{DH}	Data In Hold Time	0.5	—	0.5	—	0.5	—	0.5	—	0.5	—	0.5	—	ns
t _{WH}	Write Hold Time	0.5	—	0.5	—	0.5	—	0.5	—	0.5	—	0.5	—	ns
t _{CEH}	Chip Enable Hold Time	0.5	—	0.5	—	0.5	—	0.5	—	0.5	—	0.5	—	ns
t _{AVH}	Address Advance Hold Time	0.5	—	0.5	—	0.5	—	0.5	—	0.5	—	0.5	—	ns

WRITE CYCLE TIMING



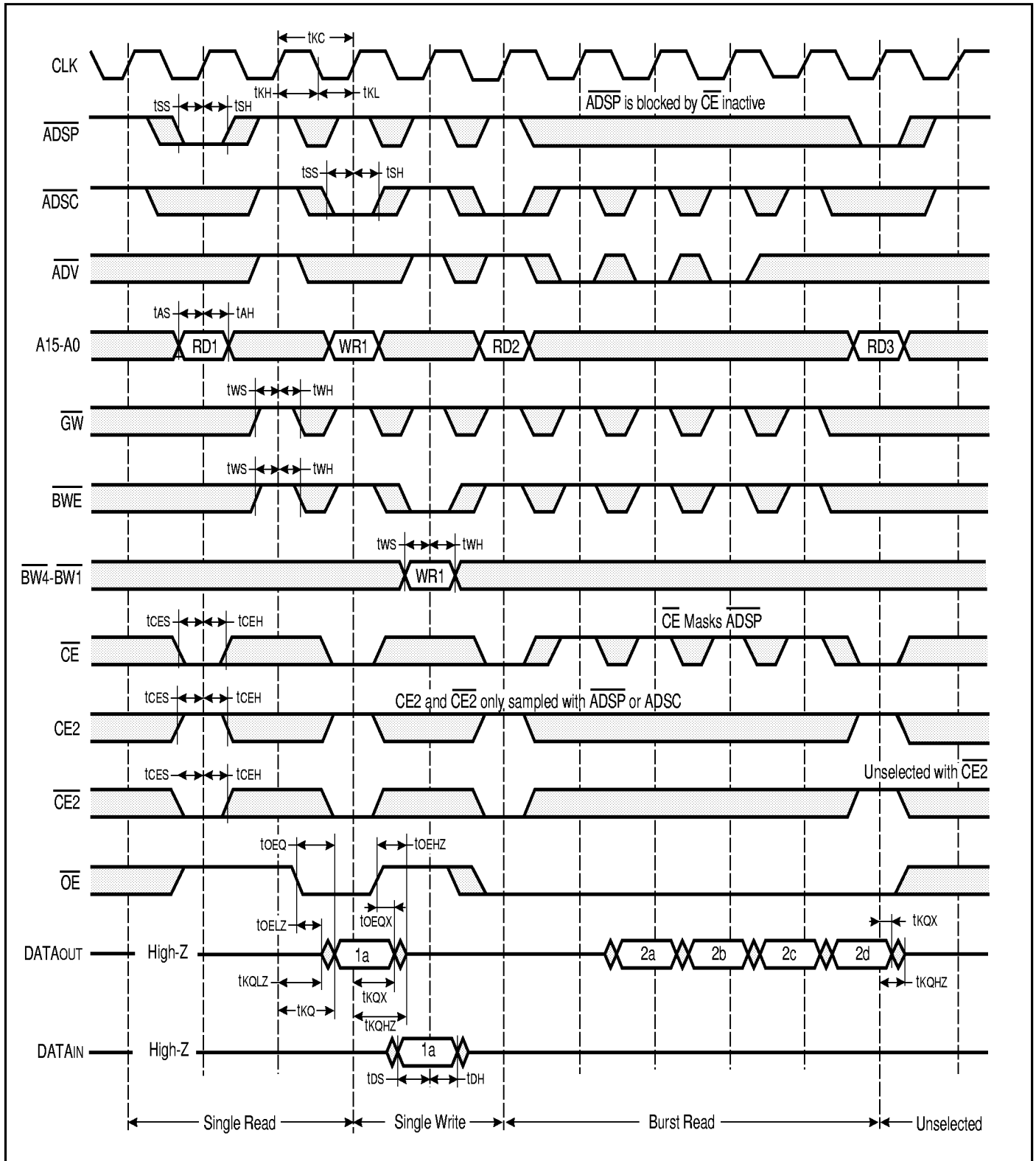
READ/WRITE CYCLE SWITCHING CHARACTERISTICS (Over Operating Range)

Symbol	Parameter	-4.5		-4.8		-5		-6		-7		-8		Unit
		Min.	Max.	Min.	Max.	Min.	Max.	Min.	Max.	Min.	Max.	Min.	Max.	
t _{CC}	Cycle Time	7.5	—	8.5	—	10	—	12	—	13	—	15	—	ns
t _{KH}	Clock High Time	1.9	—	2.5	—	3.2	—	4	—	4.5	—	5	—	ns
t _{KL}	Clock Low Time	1.9	—	2.5	—	3.2	—	4	—	4.5	—	5	—	ns
t _{KQ}	Clock Access Time	—	5	—	5	—	5	—	6	—	7	—	8	ns
t _{KQX} ⁽¹⁾	Clock High to Output Invalid	1.5	—	1.5	—	1.5	—	1.5	—	2	—	2	—	ns
t _{KQLZ} ⁽¹⁾	Clock High to Output Low-Z	0	—	0	—	0	—	0	—	0	—	0	—	ns
t _{KQHZ} ⁽¹⁾	Clock High to Output High-Z	1.5	5	1.5	6	1.5	6	1.5	6	2	6	2	6	ns
t _{OEQ}	Output Enable to Output Valid	—	5	—	5	—	5	—	6	—	6	—	6	ns
t _{OEQX} ⁽¹⁾	Output Disable to Output Invalid	0	—	0	—	0	—	0	—	0	—	0	—	ns
t _{OELZ} ⁽¹⁾	Output Enable to Output Low-Z	0	—	0	—	0	—	0	—	0	—	0	—	ns
t _{OEHZ} ⁽¹⁾	Output Disable to Output High-Z	—	3	—	4	—	4	—	5	—	5	—	6	ns
t _{AS}	Address Setup Time	2.5	—	2.5	—	2.5	—	2.5	—	2.5	—	2.5	—	ns
t _{SS}	Address Status Setup Time	2.5	—	2.5	—	2.5	—	2.5	—	2.5	—	2.5	—	ns
t _{WS}	Write Setup Time	2.5	—	2.5	—	2.5	—	2.5	—	2.5	—	2.5	—	ns
t _{CES}	Chip Enable Setup Time	2.5	—	2.5	—	2.5	—	2.5	—	2.5	—	2.5	—	ns
t _{AH}	Address Hold Time	0.5	—	0.5	—	0.5	—	0.5	—	0.5	—	0.5	—	ns
t _{SH}	Address Status Hold Time	0.5	—	0.5	—	0.5	—	0.5	—	0.5	—	0.5	—	ns
t _{WH}	Write Hold Time	0.5	—	0.5	—	0.5	—	0.5	—	0.5	—	0.5	—	ns
t _{CEH}	Chip Enable Hold Time	0.5	—	0.5	—	0.5	—	0.5	—	0.5	—	0.5	—	ns

Note:

1. Guaranteed but not 100% tested. This parameter is periodically sampled.

READ/WRITE CYCLE TIMING



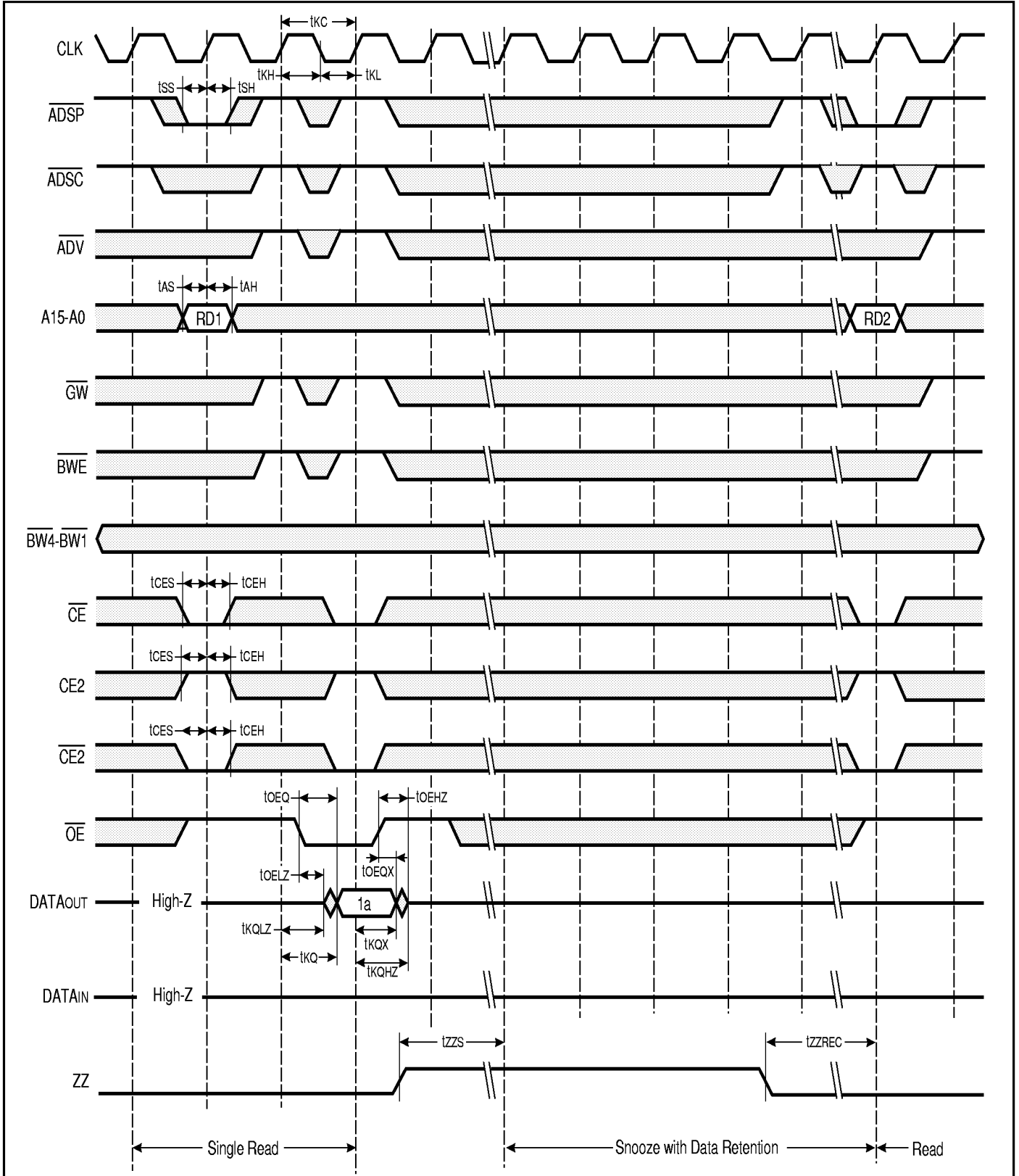
SNOOZE AND RECOVERY CYCLE SWITCHING CHARACTERISTICS (Over Operating Range)

Symbol	Parameter	-4.5	-4.8	-5	-6	-7	-8	Unit
		Min.Max.	Min.Max.	Min.Max.	Min.Max.	Min.Max.	Min.Max.	
t _{CC}	Cycle Time	7.5 —	8.5 —	10 —	12 —	13 —	15 —	ns
t _{KH}	Clock High Time	1.9 —	2.5 —	3.2 —	4 —	4.5 —	5 —	ns
t _{KL}	Clock Low Time	1.9 —	2.5 —	3.2 —	4 —	4.5 —	5 —	ns
t _{KQ}	Clock Access Time	— 5	— 5	— 5	— 6	— 7	— 8	ns
t _{KQX} ⁽³⁾	Clock High to Output Invalid	1.5 —	1.5 —	1.5 —	1.5 —	2 —	2 —	ns
t _{KQLZ} ⁽³⁾	Clock High to Output Low-Z	0 —	0 —	0 —	0 —	0 —	0 —	ns
t _{KQHZ} ⁽³⁾	Clock High to Output High-Z	1.5 5	1.5 6	1.5 6	1.5 6	2 6	2 6	ns
t _{OEQ}	Output Enable to Output Valid	— 5	— 5	— 5	— 5	— 5	— 5	ns
t _{OEQX} ⁽³⁾	Output Disable to Output Invalid	0 —	0 —	0 —	0 —	0 —	0 —	ns
t _{OELZ} ⁽³⁾	Output Enable to Output Low-Z	0 —	0 —	0 —	0 —	0 —	0 —	ns
t _{OEHZ} ⁽³⁾	Output Disable to Output High-Z	— 3	— 4	— 5	— 5	— 5	— 6	ns
t _{AS}	Address Setup Time	2.5 —	2.5 —	2.5 —	2.5 —	2.5 —	2.5 —	ns
t _{SS}	Address Status Setup Time	2.5 —	2.5 —	2.5 —	2.5 —	2.5 —	2.5 —	ns
t _{GES}	Chip Enable Setup Time	2.5 —	2.5 —	2.5 —	2.5 —	2.5 —	2.5 —	ns
t _{AH}	Address Hold Time	0.5 —	0.5 —	0.5 —	0.5 —	0.5 —	0.5 —	ns
t _{SH}	Address Status Hold Time	0.5 —	0.5 —	0.5 —	0.5 —	0.5 —	0.5 —	ns
t _{CEH}	Chip Enable Hold Time	0.5 —	0.5 —	0.5 —	0.5 —	0.5 —	0.5 —	ns
t _{ZZS} ⁽¹⁾	ZZ Standby	— 8	— 8	— 8	— 8	— 8	— 8	ns
t _{ZZREC} ⁽²⁾	ZZ Recovery	— 8	— 8	— 8	— 8	— 8	— 8	ns

Notes:

1. The assertion of ZZ allows the SRAM to enter a lower power state than when deselected within the time specified. Data retention is guaranteed when ZZ is asserted and clock remains active.
2. \overline{ADSC} and \overline{ADSP} must not be asserted for at least 100 ns after leaving ZZ state.
3. Guaranteed but not 100% tested. This parameter is periodically sampled.

SNOOZE AND RECOVERY CYCLE TIMING



ORDERING INFORMATION**Commercial Range: 0°C to +70°C**

Frequency (MHz)	Order Part Number	Package
133	IS61SP6436-4.5TQ	TQFP
	IS61SP6436-4.5PQ	PQFP
117	IS61SP6436-4.8TQ	TQFP
	IS61SP6436-4.8PQ	PQFP
100	IS61SP6436-5TQ	TQFP
	IS61SP6436-5PQ	PQFP
83	IS61SP6436-6TQ	TQFP
	IS61SP6436-6PQ	PQFP
75	IS61SP6436-7TQ	TQFP
	IS61SP6436-7PQ	PQFP
66	IS61SP6436-8TQ	TQFP
	IS61SP6436-8PQ	PQFP

Industrial Range: -40°C to +85°C

Frequency (MHz)	Order Part Number	Package
117	IS61SP6436-4.8TQI	TQFP
	IS61SP6436-4.8PQI	PQFP
100	IS61SP6436-5TQI	TQFP
	IS61SP6436-5PQI	PQFP
83	IS61SP6436-6TQI	TQFP
	IS61SP6436-6PQI	PQFP
75	IS61SP6436-7TQI	TQFP
	IS61SP6436-7PQI	PQFP
66	IS61SP6436-8TQI	TQFP
	IS61SP6436-8PQI	PQFP

ISSI®

Integrated Silicon Solution, Inc.

2231 Lawson Lane
 Santa Clara, CA 95054
 Tel: 1-800-379-4774
 Fax: (408) 588-0806
 e-mail: sales@issiusa.com
<http://www.issiusa.com>