

## ADM660/ADM8660

### FEATURES

**ADM660:** Inverts or Doubles Input Supply Voltage  
**ADM8660:** Inverts Input Supply Voltage  
**100 mA Output Current**  
**Shutdown Function (ADM8660)**  
**2.2  $\mu\text{F}$  or 10  $\mu\text{F}$  Capacitors**  
**0.3 V Drop at 30 mA Load**  
**+1.5 V to +7 V Supply**  
**Low Power CMOS: 600  $\mu\text{A}$  Quiescent Current**  
**Selectable Charge Pump Frequency (25 kHz/120 kHz)**  
**Pin Compatible Upgrade for MAX660, MAX665, ICL7660**  
**Available in 16-Lead TSSOP Package**

### APPLICATIONS

**Handheld Instruments**  
**Portable Computers**  
**Remote Data Acquisition**  
**Op Amp Power Supplies**

### GENERAL DESCRIPTION

The ADM660/ADM8660 is a charge-pump voltage converter that can be used to either invert the input supply voltage giving  $V_{\text{OUT}} = -V_{\text{IN}}$  or double it (ADM660 only) giving  $V_{\text{OUT}} = 2 \times V_{\text{IN}}$ . Input voltages ranging from +1.5 V to +7 V can be inverted into a negative -1.5 V to -7 V output supply. This inverting scheme is ideal for generating a negative rail in single power supply systems. Only two small external capacitors are needed for the charge pump. Output currents up to 50 mA with greater than 90% efficiency are achievable, while 100 mA achieves greater than 80% efficiency.

A Frequency Control (FC) input pin is used to select either 25 kHz or 120 kHz charge-pump operation. This is used to optimize capacitor size and quiescent current. With 25 kHz selected, a 10  $\mu\text{F}$  external capacitor is suitable, while with 120 kHz the capacitor may be reduced to 2.2  $\mu\text{F}$ . The oscillator frequency on the ADM660 can also be controlled with an external capacitor connected to the OSC input or by driving this input with an external clock. In applications where a higher supply voltage is desired it is possible to use the ADM660 to double the input voltage. With input voltages from 2.5 V to 7 V, output voltages from 5 V to 14 V are achievable with up to 100 mA output current.

The ADM8660 features a low power shutdown (SD) pin instead of the external oscillator (OSC) pin. This can be used to disable the device and reduce the quiescent current to 300 nA.

### TYPICAL CIRCUIT CONFIGURATIONS

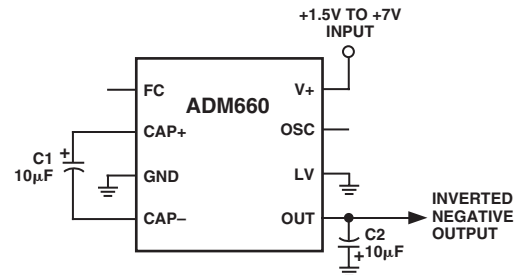

Voltage Inverter Configuration (ADM660)

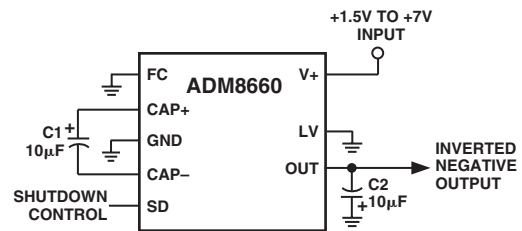

Voltage Inverter Configuration with Shutdown (ADM8660)

The ADM660 is a pin compatible upgrade for the MAX660, MAX665, ICL7660, and LTC1046.

The ADM660/ADM8660 is available in 8-lead DIP and narrow-body SOIC. The ADM660 is also available in a 16-lead TSSOP package.

### ADM660/ADM8660 Options

| Option              | ADM660 | ADM8660 |
|---------------------|--------|---------|
| Inverting Mode      | Y      | Y       |
| Doubling Mode       | Y      | N       |
| External Oscillator | Y      | N       |
| Shutdown            | N      | Y       |
| Package Options     |        |         |
| R-8                 | Y      | Y       |
| N-8                 | Y      | Y       |
| RU-16               | Y      | N       |

### REV.C

Information furnished by Analog Devices is believed to be accurate and reliable. However, no responsibility is assumed by Analog Devices for its use, nor for any infringements of patents or other rights of third parties that may result from its use. No license is granted by implication or otherwise under any patent or patent rights of Analog Devices. Trademarks and registered trademarks are the property of their respective companies.

# ADM660/ADM8660—SPECIFICATIONS (V+ = +5 V, C1, C2 = 10 $\mu$ F, \* T<sub>A</sub> = T<sub>MIN</sub> to T<sub>MAX</sub>, unless otherwise noted.)

| Parameter                                  | Min  | Typ      | Max  | Unit     | Test Conditions/Comments  |
|--|------|----------|------|----------|---|
| Input Voltage, V+                          | 3.5  |          | 7.0  | V        | R <sub>L</sub> = 1 k $\Omega$<br>Inverting Mode, LV = Open                                  |
|  | 1.5  |          | 7.0  | V        | Inverting Mode, LV = GND  |
|  | 2.5  |          | 7.0  | V        | Doubling Mode, LV = OUT   |
| Supply Current                             |      | 0.6      | 1    | mA       | No Load<br>FC = Open (ADM660), GND (ADM8660)  |
|  |      | 2.5      | 4.5  | mA       | FC = V+, LV = Open  |
| Output Current                             | 100  |          |      | mA       |   |
| Output Resistance (ADM660)                 |      | 9        | 15   | $\Omega$ | I <sub>L</sub> = 100 mA   |
| Output Resistance (ADM8660)                |      | 9        | 15   | $\Omega$ | I <sub>L</sub> = 100 mA, T <sub>A</sub> = 25°C  |
| Output Resistance (ADM8660)                |      |          | 16.5 | $\Omega$ | I <sub>L</sub> = 100 mA, T <sub>A</sub> = -40°C to +85°C                                    |
| Charge-Pump Frequency                      |      | 25       |      | kHz      | FC = Open (ADM660), GND (ADM8660)   |
|  |      | 120      |      | kHz      | FC = V+   |
| OSC Input Current                          |      | $\pm 5$  |      | $\mu$ A  | FC = Open (ADM660), GND (ADM8660)   |
|  |      | $\pm 25$ |      | $\mu$ A  | FC = V+   |
| Power Efficiency (FC = Open) (ADM660)      | 90   | 94       |      | %        | R <sub>L</sub> = 1 k $\Omega$ Connected from V+ to OUT                                      |
| Power Efficiency (FC = Open) (ADM8660)     | 90   | 94       |      | %        | R <sub>L</sub> = 1 k $\Omega$ Connected from V+ to OUT,<br>T <sub>A</sub> = +25°C           |
| Power Efficiency (FC = Open) (ADM8660)     | 88.5 |          |      | %        | R <sub>L</sub> = 1 k $\Omega$ Connected from V+ to OUT,<br>T <sub>A</sub> = -40°C to +85°C  |
| Power Efficiency (FC = Open) (ADM660)      | 90   | 93       |      | %        | R <sub>L</sub> = 500 $\Omega$ Connected from OUT to GND                                     |
| Power Efficiency (FC = Open) (ADM8660)     | 90   | 93       |      | %        | R <sub>L</sub> = 500 $\Omega$ Connected from OUT to GND,<br>T <sub>A</sub> = +25°C          |
| Power Efficiency (FC = Open) (ADM8660)     | 88.5 |          |      | %        | R <sub>L</sub> = 500 $\Omega$ Connected from OUT to GND,<br>T <sub>A</sub> = -40°C to +85°C |
| Power Efficiency (FC = Open)               |      | 81.5     |      | %        | I <sub>L</sub> = 100 mA to GND  |
| Voltage Conversion Efficiency              | 99   | 99.96    |      | %        | No Load   |
| Shutdown Supply Current, I <sub>SHDN</sub> |      | 0.3      | 5    | $\mu$ A  | ADM8660, SHDN = V+  |
| Shutdown Input Voltage, V <sub>SHDN</sub>  | 2.4  |          |      | V        | SHDN High = Disabled  |
|  |      |          | 0.8  | V        | SHDN Low = Enabled  |
| Shutdown Exit Time                         |      | 500      |      | $\mu$ s  | I <sub>L</sub> = 100 mA   |

\*C1 and C2 are low ESR (<0.2  $\Omega$ ) electrolytic capacitors.  
High ESR degrade performance.

Specifications subject to change without notice.

## ABSOLUTE MAXIMUM RATINGS\*

( $T_A = +25^\circ\text{C}$ , unless otherwise noted.)

|  |                               |
|--|-------------------------------|
| Input Voltage (V+ to GND, GND to OUT) . . . . .  | +7.5 V                        |
| LV Input Voltage . . . . . (OUT - 0.3 V) to (V+, +0.3 V)                                       |                               |
| FC and OSC Input Voltage . . . . . (OUT - 0.3 V) or (V+, -6 V) to (V+, +0.3 V)                 |                               |
| OUT, V+ Output Current (Continuous) . . . . .  | 120 mA                        |
| Output Short Circuit Duration to GND . . . . .   | 10 secs                       |
| Power Dissipation, N-8 . . . . . (Derate 8.3 mW/ $^\circ\text{C}$ above +50 $^\circ\text{C}$ ) | 625 mW                        |
| $\theta_{JA}$ , Thermal Impedance . . . . .  | 120 $^\circ\text{C}/\text{W}$ |
| Power Dissipation, R-8 . . . . . (Derate 6 mW/ $^\circ\text{C}$ above +50 $^\circ\text{C}$ )   | 450 mW                        |
| $\theta_{JA}$ , Thermal Impedance . . . . .  | 170 $^\circ\text{C}/\text{W}$ |

|  |   |
|--|---|
| Power Dissipation, RU-16 . . . . . (Derate 6 mW/ $^\circ\text{C}$ above +50 $^\circ\text{C}$ ) | 500 mW  |
| $\theta_{JA}$ , Thermal Impedance . . . . .  | 158 $^\circ\text{C}/\text{W}$                 |
| Operating Temperature Range  |   |
| Industrial (A Version) . . . . .   | -40 $^\circ\text{C}$ to +85 $^\circ\text{C}$  |
| Storage Temperature Range . . . . .  | -65 $^\circ\text{C}$ to +150 $^\circ\text{C}$ |
| Lead Temperature Range (Soldering 10 sec) . . . . .  | +300 $^\circ\text{C}$                         |
| Vapor Phase (60 sec) . . . . .   | +215 $^\circ\text{C}$                         |
| Infrared (15 sec) . . . . .  | +220 $^\circ\text{C}$                         |
| ESD Rating . . . . .   | >2000 V                                       |

\*This is a stress rating only; functional operation of the device at these or any other conditions above those indicated in the operation section of this specification is not implied. Exposure to absolute maximum rating conditions for extended periods may affect device reliability.

## CAUTION

ESD (electrostatic discharge) sensitive device. Electrostatic charges as high as 4000 V readily accumulate on the human body and test equipment and can discharge without detection. Although the ADM660/ADM8660 features proprietary ESD protection circuitry, permanent damage may occur on devices subjected to high energy electrostatic discharges. Therefore, proper ESD precautions are recommended to avoid performance degradation or loss of functionality.



# ADM660/ADM8660

## PIN CONNECTIONS

### 8-Lead

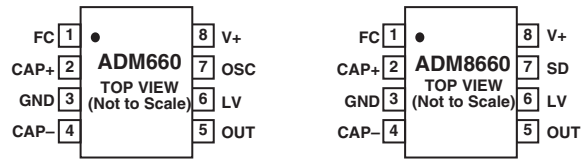

### 16-Lead

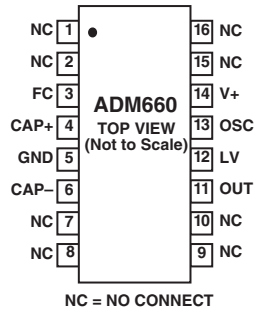

## PIN FUNCTION DESCRIPTIONS

### Inverter Configuration

| Mnemonic | Function  |
|----------|---|
| FC       | Frequency Control Input for Internal Oscillator and Charge Pump. With FC = Open (ADM660) or connected to GND (ADM8660), $f_{CP} = 25$ kHz; with FC = V+, $f_{CP} = 120$ kHz.  |
| CAP+     | Positive Charge-Pump Capacitor Terminal.  |
| GND      | Power Supply Ground.  |
| CAP-     | Negative Charge-Pump Capacitor Terminal.  |
| OUT      | Output, Negative Voltage.   |
| LV       | Low Voltage Operation Input. Connect to GND when input voltage is less than 3.5 V. Above 3.5 V, LV may be connected to GND or left unconnected.   |
| OSC      | ADM660: Oscillator Control Input. OSC is connected to an internal 15 pF capacitor. An external capacitor may be connected to slow the oscillator. An external oscillator may also be used to overdrive OSC. The charge-pump frequency is equal to 1/2 the oscillator frequency. |
| SD       | ADM8660: Shutdown Control Input. This input, when high, is used to disable the charge pump thereby reducing the power consumption.  |
| V+       | Positive Power Supply Input.  |

### Doubler Configuration (ADM660 Only)

| Mnemonic | Function  |
|----------|---|
| FC       | Frequency Control Input for Internal Oscillator and Charge Pump. With FC = Open, $f_{CP} = 25$ kHz; with FC = V+, $f_{CP} = 120$ kHz. |
| CAP+     | Positive Charge-Pump Capacitor Terminal.  |
| GND      | Positive Input Supply.  |
| CAP-     | Negative Charge-Pump Capacitor Terminal.  |
| OUT      | Ground.   |
| LV       | Low Voltage Operation Input. Connect to OUT.  |
| OSC      | Must be left unconnected in this mode.  |
| V+       | Doubled Positive Output.  |

# Typical Performance Characteristics—ADM660/ADM8660

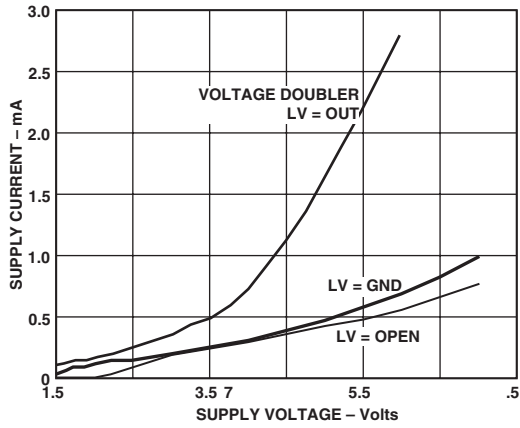

TPC 1. Power Supply Current vs. Voltage

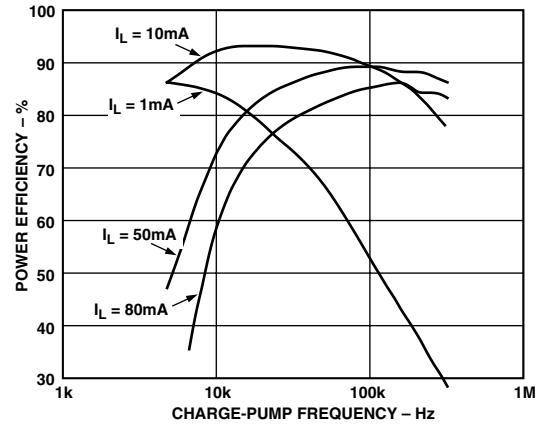

TPC 4. Efficiency vs. Charge-Pump Frequency

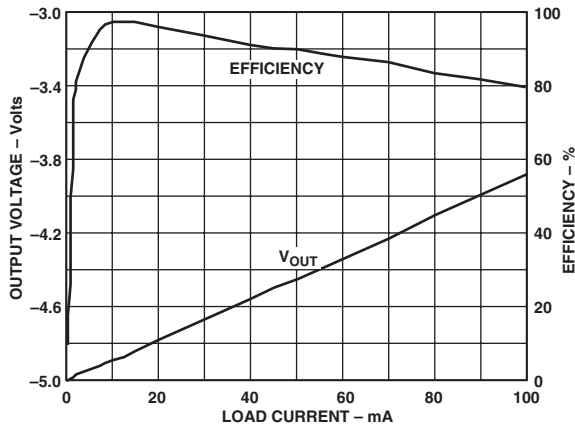

TPC 2. Output Voltage and Efficiency vs. Load Current

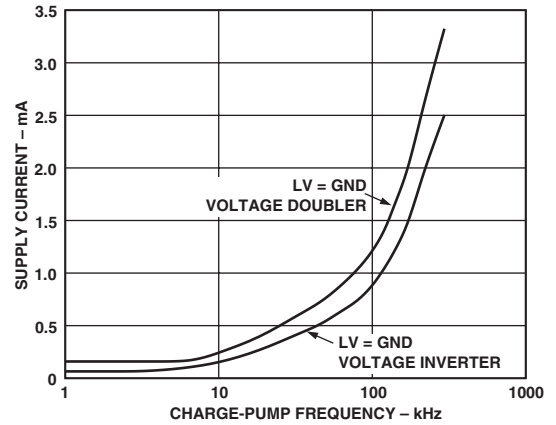

TPC 5. Power Supply Current vs. Charge-Pump Frequency

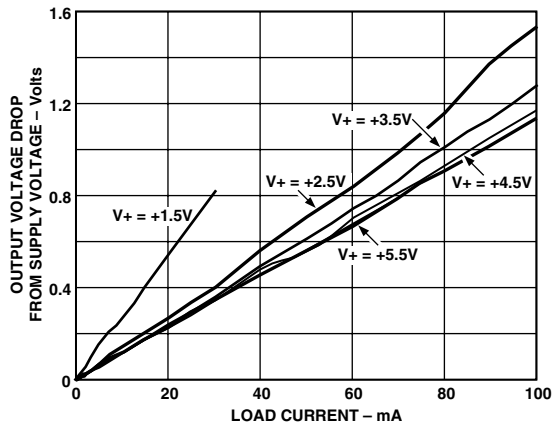

TPC 3. Output Voltage Drop vs. Load Current

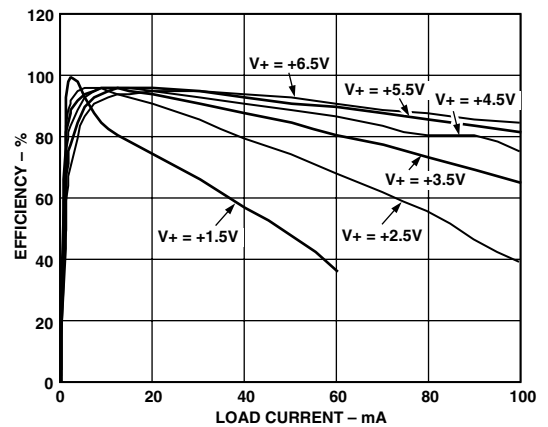

TPC 6. Power Efficiency vs. Load Current

# ADM660/ADM8660

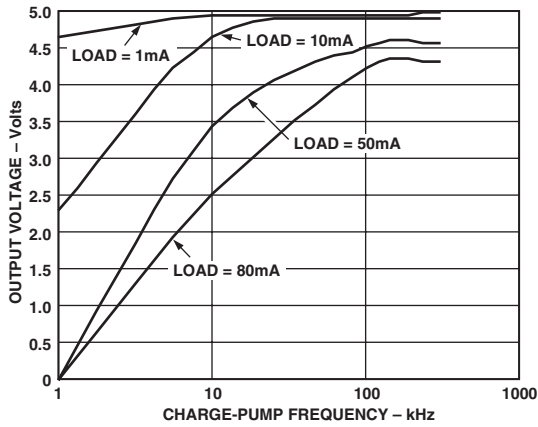

TPC 7. Output Voltage vs. Charge-Pump Frequency

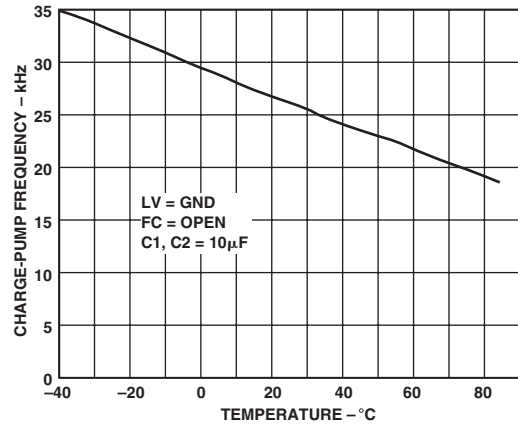

TPC 10. Charge-Pump Frequency vs. Temperature

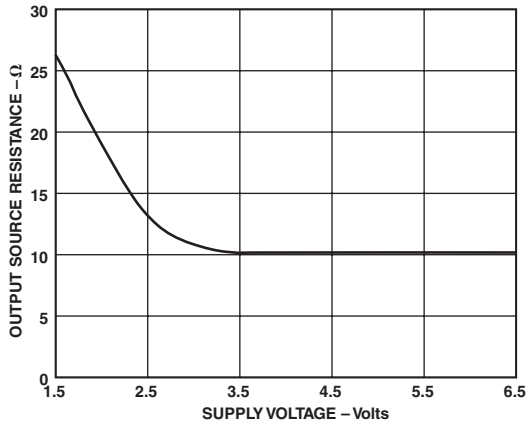

TPC 8. Output Source Resistance vs. Supply Voltage

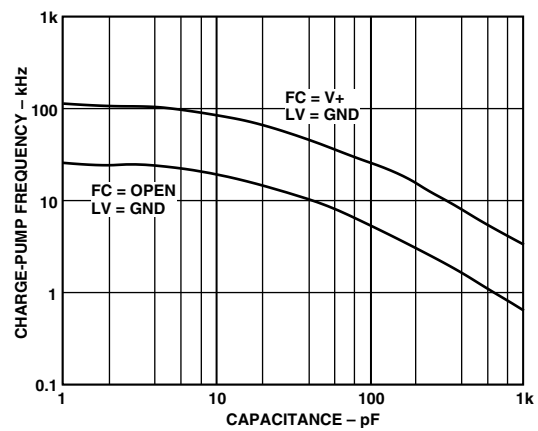

TPC 11. Charge-Pump Frequency vs. External Capacitance

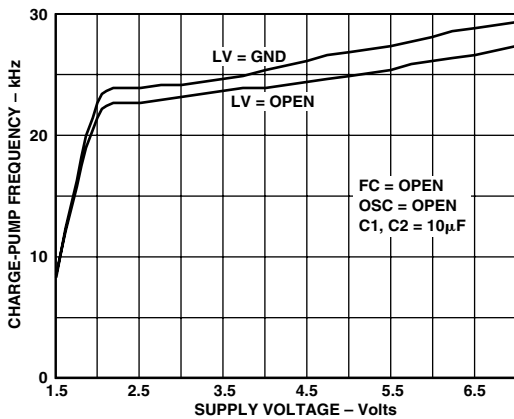

TPC 9. Charge-Pump Frequency vs. Supply Voltage

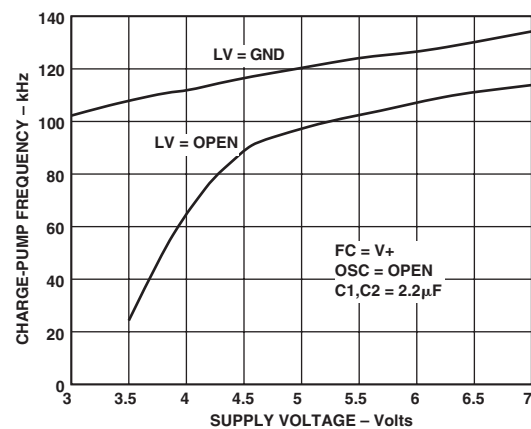

TPC 12. Charge-Pump Frequency vs. Supply Voltage

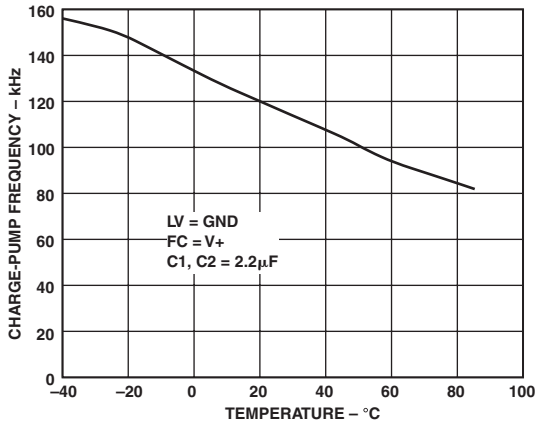

TPC 13. Charge-Pump Frequency vs. Temperature

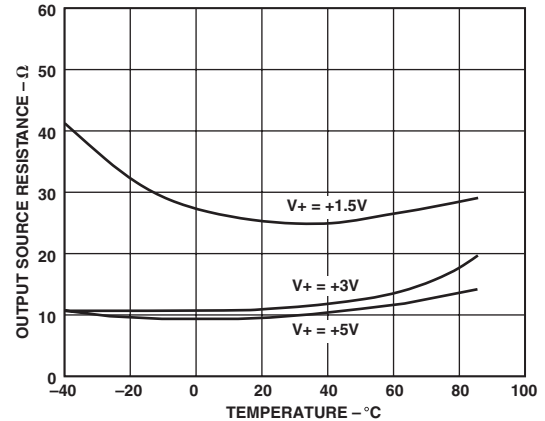

TPC 14. Output Resistance vs. Temperature

### GENERAL INFORMATION

The ADM660/ADM8660 is a switched capacitor voltage converter that can be used to invert the input supply voltage. The ADM660 can also be used in a voltage doubling mode. The voltage conversion task is achieved using a switched capacitor technique using two external charge storage capacitors. An on-board oscillator and switching network transfers charge between the charge storage capacitors. The basic principle behind the voltage conversion scheme is illustrated in Figures 1 and 2.

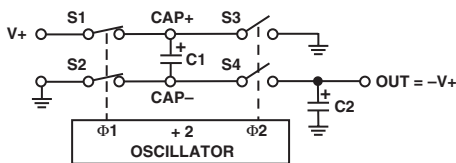

Figure 1. Voltage Inversion Principle

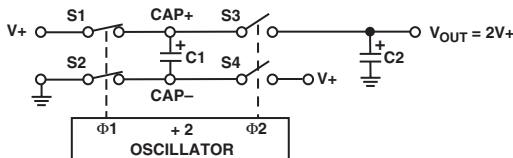

Figure 2. Voltage Doubling Principle

Figure 1 shows the voltage inverting configuration, while Figure 2 shows the configuration for voltage doubling. An oscillator generating antiphase signals  $\phi 1$  and  $\phi 2$  controls switches S1, S2, and S3, S4. During  $\phi 1$ , switches S1 and S2 are closed charging C1 up to the voltage at V+. During  $\phi 2$ , S1 and S2 open and S3 and S4 close. With the voltage inverter configuration during  $\phi 2$ , the positive terminal of C1 is connected to GND via S3 and the negative terminal of C1 connects to  $V_{OUT}$  via S4. The net result is voltage inversion at  $V_{OUT}$  wrt GND. Charge on C1 is transferred to C2 during  $\phi 1$ . Capacitor C2 maintains this voltage during  $\phi 1$ . The charge transfer efficiency depends on the on-resistance of the switches, the frequency at which they are being switched, and also on the equivalent series resistance (ESR) of the external capacitors. The reason for this is explained in the following section. For maximum efficiency, capacitors with low ESR are, therefore, recommended.

The voltage doubling configuration reverses some of the connections, but the same principle applies.

### Switched Capacitor Theory of Operation

As already described, the charge pump on the ADM660/ADM8660 uses a switched capacitor technique in order to invert or double the input supply voltage. Basic switched capacitor theory is discussed below.

A switched capacitor building block is illustrated in Figure 3. With the switch in position A, capacitor C1 will charge to voltage V1. The total charge stored on C1 is  $q_1 = C_1V_1$ . The switch is then flipped to position B discharging C1 to voltage V2. The charge remaining on C1 is  $q_2 = C_1V_2$ . The charge transferred to the output V2 is, therefore, the difference between  $q_1$  and  $q_2$ , so  $\Delta q = q_1 - q_2 = C_1(V_1 - V_2)$ .

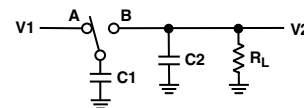

Figure 3. Switched Capacitor Building Block

As the switch is toggled between A and B at a frequency  $f$ , the charge transfer per unit time or current is:

$$I = f(\Delta q) = f(C_1)(V_1 - V_2)$$

Therefore,

$$I = (V_1 - V_2)/(1/fC_1) = (V_1 - V_2)/(R_{EQ})$$

where  $R_{EQ} = 1/fC_1$

The switched capacitor may, therefore, be replaced by an equivalent resistance whose value is dependent on both the capacitor size and the switching frequency. This explains why lower capacitor values may be used with higher switching frequencies. It should be remembered that as the switching frequency is increased the power consumption will increase due to some charge being lost at each switching cycle. As a result, at high frequencies, the power efficiency starts decreasing. Other losses include the resistance of the internal switches and the equivalent series resistance (ESR) of the charge storage capacitors.

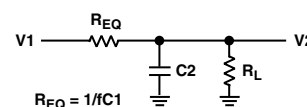

Figure 4. Switched Capacitor Equivalent Circuit



# ADM660/ADM8660

## Inverting Negative Voltage Generator

Figures 5 and 6 show the ADM660/ADM8660 configured to generate a negative output voltage. Input supply voltages from 1.5 V up to 7 V are allowable. For supply voltage less than 3 V, LV must be connected to GND. This bypasses the internal regulator circuitry and gives best performance in low voltage applications. With supply voltages greater than 3 V, LV may be either connected to GND or left open. Leaving it open facilitates direct substitution for the ICL7660.

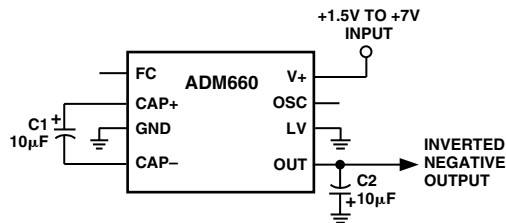

Figure 5. ADM660 Voltage Inverter Configuration

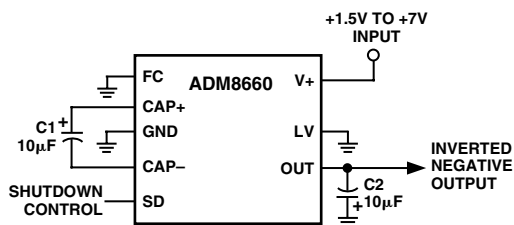

Figure 6. ADM8660 Voltage Inverter Configuration

## OSCILLATOR FREQUENCY

The internal charge-pump frequency may be selected to be either 25 kHz or 120 kHz using the Frequency Control (FC) input. With FC unconnected (ADM660) or connected to GND (ADM8660), the internal charge pump runs at 25 kHz while, if FC is connected to V+, the frequency is increased by a factor of five. Increasing the frequency allows smaller capacitors to be used for equivalent performance or, if the capacitor size is unchanged, it results in lower output impedance and ripple.

If a charge-pump frequency other than the two fixed values is desired, this is made possible by the OSC input, which can either have a capacitor connected to it or be overdriven by an external clock. Refer to the Typical Performance Characteristics, which shows the variation in charge-pump frequency versus capacitor size. The charge-pump frequency is one-half the oscillator frequency applied to the OSC pin.

If an external clock is used to overdrive the oscillator, its levels should swing to within 100 mV of V+ and GND. A CMOS driver is, therefore, suitable. When OSC is overdriven, FC has no effect but LV must be grounded.

Note that overdriving is permitted only in the voltage inverter configuration.

Table I. ADM660 Charge-Pump Frequency Selection

| FC         | OSC     | Charge Pump                 | C1, C2 |
|------------|---------|-----------------------------|--------|
| Open       | Open    | 25 kHz                      | 10 µF  |
| V+         | Open    | 120 kHz                     | 2.2 µF |
| Open or V+ | Ext Cap | See Typical Characteristics |        |
| Open       | Ext CLK | Ext CLK Frequency/2         |        |

Table II. ADM8660 Charge-Pump Frequency Selection

| FC        | OSC     | Charge Pump                 | C1, C2 |
|-----------|---------|-----------------------------|--------|
| GND       | Open    | 25 kHz                      | 10 µF  |
| V+        | Open    | 120 kHz                     | 2.2 µF |
| GND or V+ | Ext Cap | See Typical Characteristics |        |
| GND       | Ext CLK | Ext CLK Frequency/2         |        |

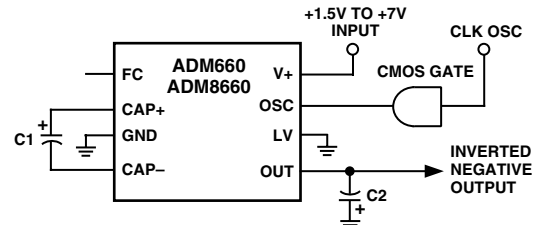

Figure 7. ADM660/ADM8660 External Oscillator

## Voltage Doubling Configuration

Figure 8 shows the ADM660 configured to generate increased output voltages. As in the inverting mode, only two external capacitors are required. The doubling function is achieved by reversing some connections to the device. The input voltage is applied to the GND pin and V+ is used as the output. Input voltages from 2.5 V to 7 V are allowable. In this configuration, pins LV, OUT must be connected to GND.

The unloaded output voltage in this configuration is 2 (V<sub>IN</sub>). Output resistance and ripple are similar to the voltage inverting configuration.

**Note that the ADM8660 cannot be used in the voltage doubling configuration.**

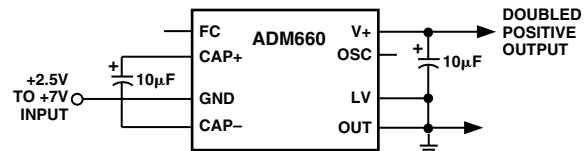

Figure 8. Voltage Doubler Configuration

## Shutdown Input

The ADM8660 contains a shutdown input that can be used to disable the device and thus reduce the power consumption. A logic high level on the SD input shuts the device down reducing the quiescent current to 0.3 µA. During shutdown, the output voltage goes to 0 V. Therefore, ground referenced loads are not powered during this state. When exiting shutdown, it takes several cycles (approximately 500 µs) for the charge pump to reach its final value. If the shutdown function is not being used, then SD should be hardwired to GND.

## Capacitor Selection

The optimum capacitor value selection depends the charge-pump frequency. With 25 kHz selected, 10 µF capacitors are recommended, while with 120 kHz selected, 2.2 µF capacitors may be used. Other frequencies allow other capacitor values to be used. For maximum efficiency in all cases, it is recommended that capacitors with low ESR are used for the charge-pump. Low ESR capacitors give both the lowest output resistance and lowest ripple voltage. High output resistance degrades the overall power efficiency and causes voltage drops, especially at high output



current levels. The ADM660/ADM8660 is tested using low ESR, 10  $\mu\text{F}$ , capacitors for both C1 and C2. Smaller values of C1 increase the output resistance, while increasing C1 will reduce the output resistance. The output resistance is also dependent on the internal switches on resistance as well as the capacitors ESR, so the effect of increasing C1 becomes negligible past a certain point.

Figure 9 shows how the output resistance varies with oscillator frequency for three different capacitor values. At low oscillator frequencies, the output impedance is dominated by the  $1/f_C$  term. This explains why the output impedance is higher for smaller capacitance values. At high oscillator frequencies, the  $1/f_C$  term becomes insignificant and the output impedance is dominated by the internal switches on resistance. From an output impedance viewpoint, therefore, there is no benefit to be gained from using excessively large capacitors.

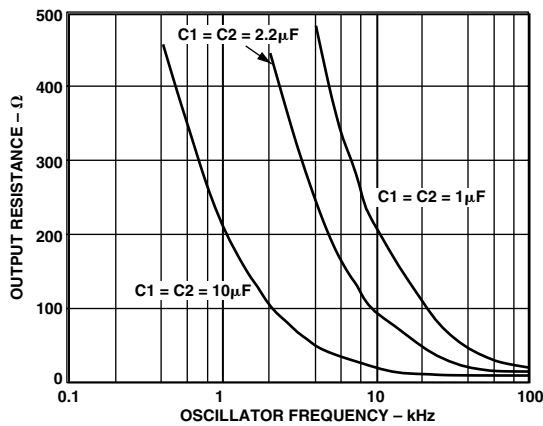

Figure 9. Output Impedance vs. Oscillator Frequency

### Capacitor C2

The output capacitor size C2 affects the output ripple. Increasing the capacitor size reduces the peak-to-peak ripple. The ESR affects both the output impedance and the output ripple. Reducing the ESR reduces the output impedance and ripple. For convenience it is recommended that both C1 and C2 be the same value.

Table III. Capacitor Selection

| Charge-Pump Frequency | Capacitor C1, C2  |
|-----------------------|-------------------|
| 25 kHz                | 10 $\mu\text{F}$  |
| 120 kHz               | 2.2 $\mu\text{F}$ |

### Power Efficiency and Oscillator Frequency Trade-Off

While higher switching frequencies allow smaller capacitors to be used for equivalent performance, or improved performance with the same capacitors, there is a trade-off to consider. As the oscillator frequency is increased, the quiescent current increases. This happens as a result of a finite charge being lost at each switching cycle. The charge loss per unit cycle at very high frequencies can be significant, thereby reducing the power efficiency. Since the power efficiency is also degraded at low oscillator frequencies due to an increase in output impedance, this means that there is an optimum frequency band for maximum power transfer. Refer to the Typical Performance Characteristics section.

### Bypass Capacitor

The ac impedance of the ADM660/ADM8660 may be reduced by using a bypass capacitor on the input supply. This capacitor should be connected between the input supply and GND. It will provide instantaneous current surges as required. Suitable capacitors of 0.1  $\mu\text{F}$  or greater may be used.

# ADM660/ADM8660

## OUTLINE DIMENSIONS

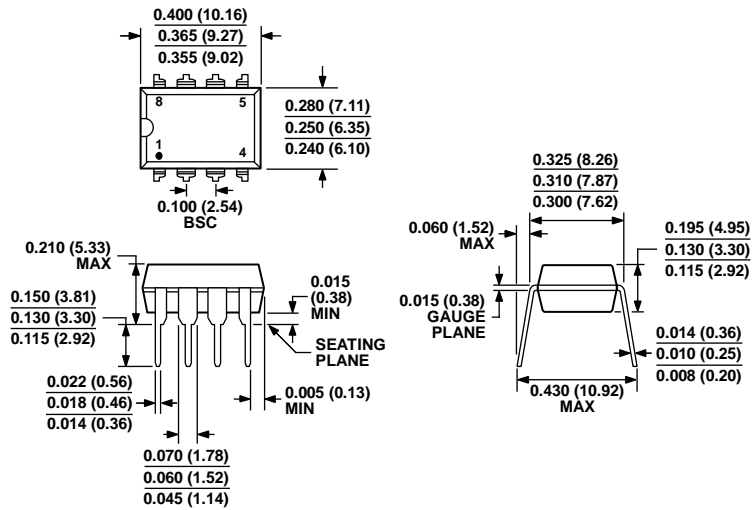

COMPLIANT TO JEDEC STANDARDS MS-001  
CONTROLLING DIMENSIONS ARE IN INCHES; MILLIMETER DIMENSIONS (IN PARENTHESES) ARE ROUNDED-OFF INCH EQUIVALENTS FOR REFERENCE ONLY AND ARE NOT APPROPRIATE FOR USE IN DESIGN. CORNER LEADS MAY BE CONFIGURED AS WHOLE OR HALF LEADS.

Figure 10. 8-Lead Plastic Dual In-Line Package [PDIP]  
Narrow Body  
(N-8)

Dimensions shown in inches and (millimeters)

070606-A

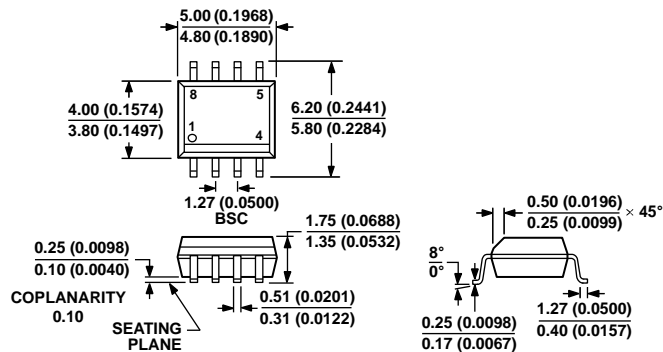

COMPLIANT TO JEDEC STANDARDS MS-012-AA  
CONTROLLING DIMENSIONS ARE IN MILLIMETERS; INCH DIMENSIONS (IN PARENTHESES) ARE ROUNDED-OFF MILLIMETER EQUIVALENTS FOR REFERENCE ONLY AND ARE NOT APPROPRIATE FOR USE IN DESIGN.

Figure 11. 8-Lead Standard Small Outline Package [SOIC\_N]  
Narrow Body  
(R-8)

Dimensions shown in millimeters and (inches)

012407-A

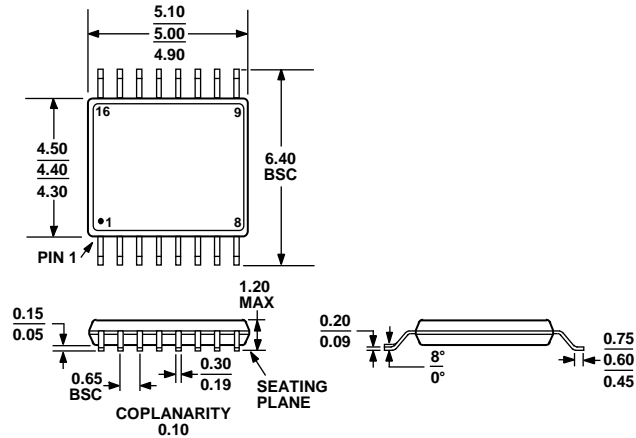

COMPLIANT TO JEDEC STANDARDS MO-153-AB  
 Figure 12. 16-Lead Thin Shrink Small Outline Package [TSSOP]  
 (RU-16)  
 Dimensions shown in millimeters

**ORDERING GUIDE**

| Model <sup>1</sup> | Temperature Range | Package Description                               | Package Option |
|--------------------|-------------------|---|----------------|
| ADM660ANZ          | -40°C to +85°C    | 8-Lead Plastic Dual In-Line Package [PDIP]        | N-8            |
| ADM660ARZ          | -40°C to +85°C    | 8-Lead Standard Small Outline Package [SOIC_N]    | R-8            |
| ADM660ARZ-REEL     | -40°C to +85°C    | 8-Lead Standard Small Outline Package [SOIC_N]    | R-8            |
| ADM660ARUZ         | -40°C to +85°C    | 16-Lead Thin Shrink Small Outline Package [TSSOP] | RU-16          |
| ADM660ARUZ-REEL    | -40°C to +85°C    | 16-Lead Thin Shrink Small Outline Package [TSSOP] | RU-16          |
| ADM660ARUZ-REEL7   | -40°C to +85°C    | 16-Lead Thin Shrink Small Outline Package [TSSOP] | RU-16          |
| ADM8660ANZ         | -40°C to +85°C    | 8-Lead Plastic Dual In-Line Package [PDIP]        | N-8            |
| ADM8660ARZ         | -40°C to +85°C    | 8-Lead Standard Small Outline Package [SOIC_N]    | R-8            |
| ADM8660ARZ-REEL    | -40°C to +85°C    | 8-Lead Standard Small Outline Package [SOIC_N]    | R-8            |

<sup>1</sup> Z = RoHS Compliant Part

**REVISION HISTORY**

**4/11—Rev. B to Rev. C**

Changes to Ordering Guide ..... 11

**12/02—Rev. A to Rev. B**

Renumbered TPCs and Figures ..... Universal

Edits to Specifications ..... 2

Updated Absolute Maximum Ratings ..... 3

Updated Outline Dimensions ..... 10