

# GVH CONNECTOR

1.25mm pitch/Disconnectable Crimp style connectors

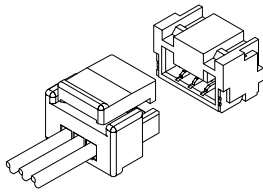

## Side entry type



## Side feed type

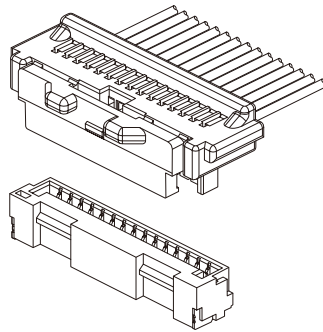

**This connector can be mounted on the same PC board layout as GH connector, and has the sucking area on the top of connector without suction tape. The side feed type for drawing out the wire laterally that considers the workability of mating and normal side entry type has been developed.**

- Secure locking structure
- Prevention of contact deformation
- Sucking area

## Specifications

- Current rating: 1.0A AC, DC (AWG #26)
  - Voltage rating: 50V AC, DC
  - Temperature range: -25°C to +85°C (including temperature rise in applying electrical current)
  - Contact resistance: Initial value/30mΩ max. After environmental testing/50mΩ max.
  - Insulation resistance: 100MΩ min.
  - Withstanding voltage: 500V AC/minute
  - Applicable wire: Conductor size/AWG #30 to #26 Insulation O.D./0.8 to 1.0mm
- \* Compliant with RoHS.  
 \* Refer to "General Instruction and Notice when using Terminals and Connectors" at the end of this catalog.  
 \* Contact JST for details.

## Standards

Recognized E 60389

## PC board layout (viewed from component side) and Assembly layout

### Side entry type

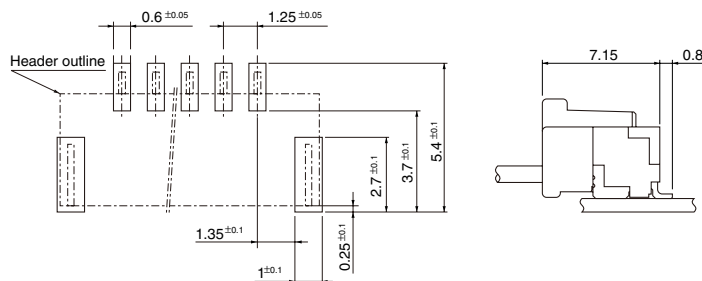

### Side feed type

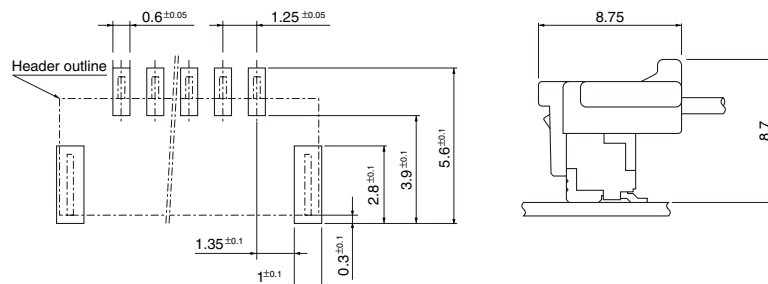

Note: 1. Tolerances are non-cumulative:  $\pm 0.05\text{mm}$  for all centers.  
 2. The dimensions above should serve as a guideline. Contact JST for details.

# GVH CONNECTOR

## Contact

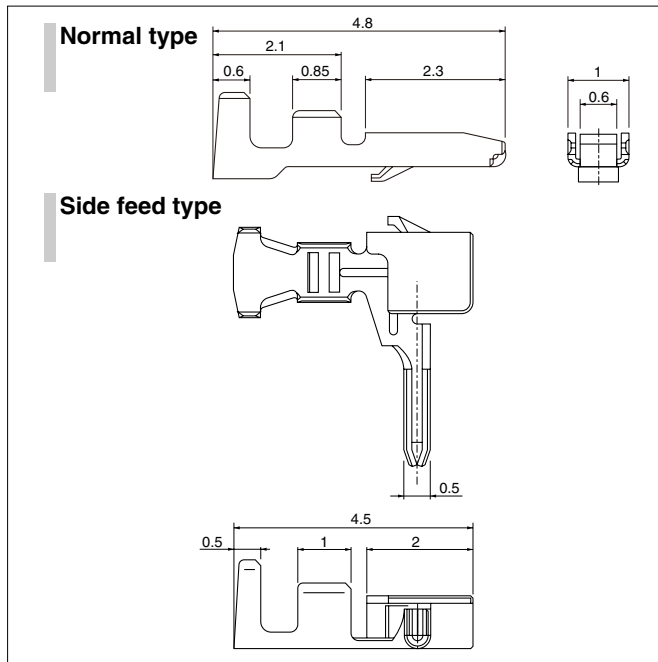

Model No.	Applicable wire		Insulation O.D. (mm)	Q'ty / reel
	mm <sup>2</sup>	AWG#		
<b>SGVH-002T-P0.2</b>	0.05~0.13	30~26	0.8~1.0	23,000
<b>SGVHSF-002T-0.2</b>	0.05~0.13	30~26	0.8~1.0	13,000

### Material and Finish

Side entry type: Phosphor bronze, tin-plated (reflow treatment)

Side feed type: Brass, tin-plated (reflow treatment)

### RoHS compliance

Note: 1. Contact JST for gold-plated products.

2. Contact JST when it is used for the equipment for outdoor use and the part required high reliability, because the side feed type can correspond with phosphor bronze products.

Contact	Crimping machine	Applicator		
		Crimp applicator	Dies	Crimp applicator with dies
<b>SGVH-002T-P0.2</b>	AP-K2N	MKS-L-10-3	MK/SSHL-002-02	APLMK SSSL002-02
		-	-	-
<b>SGVHSF-002T-0.2</b>	AP-K2N	MKS-L-10-3	MK/SGVHSF-002-02	APLMK SGVHSF002-02
		-	-	-

## Housing

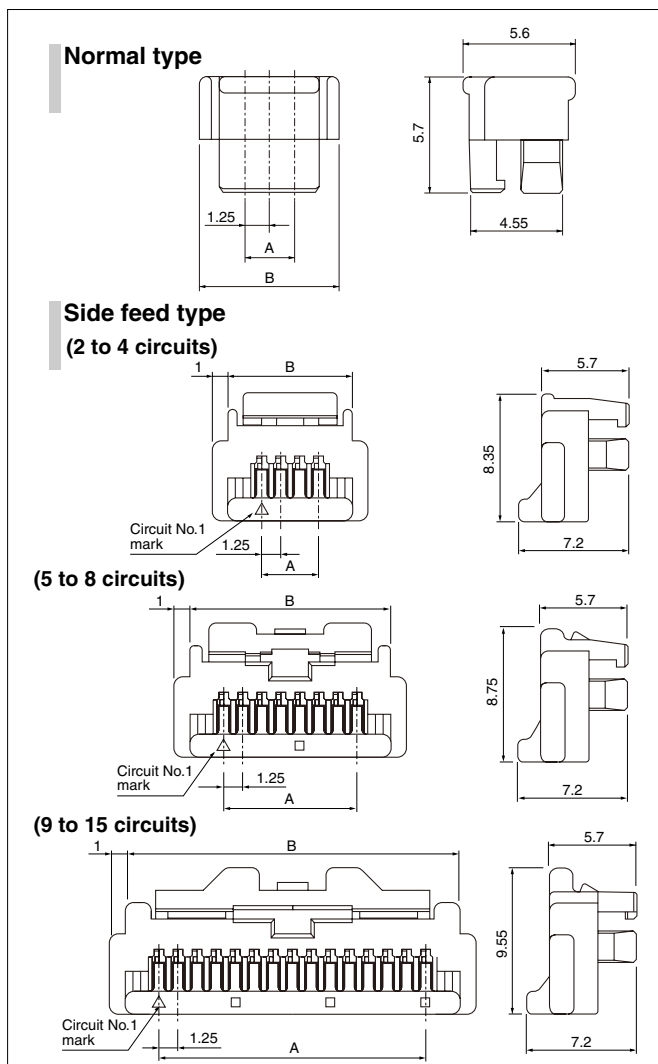

Circuits	Model No.	Dimensions (mm)		Q'ty / box
		A	B	
3	<b>GVHR-03V-S</b>	2.50	7.00	5,000

### Material

PBT, UL94V-0, natural

### RoHS compliance

Circuits	Model No.	Dimensions (mm)		Q'ty / box
		A	B	
2	<b>GVHRSF-02V-S</b>	1.25	3.75	4,000
3	<b>GVHRSF-03V-S</b>	2.50	5.00	4,000
4	<b>GVHRSF-04V-S</b>	3.75	6.25	2,500
5	<b>GVHRSF-05V-S</b>	5.00	7.50	2,500
6	<b>GVHRSF-06V-S</b>	6.25	8.75	2,500
7	<b>GVHRSF-07V-S</b>	7.50	10.00	2,000
8	<b>GVHRSF-08V-S</b>	8.75	11.25	2,000
9	<b>GVHRSF-09V-S</b>	10.00	12.50	1,500
10	<b>GVHRSF-10V-S</b>	11.25	13.75	1,500
11	<b>GVHRSF-11V-S</b>	12.50	15.00	1,500
12	<b>GVHRSF-12V-S</b>	13.75	16.25	1,000
13	<b>GVHRSF-13V-S</b>	15.00	17.50	1,000
14	<b>GVHRSF-14V-S</b>	16.25	18.75	1,000
15	<b>GVHRSF-15V-S</b>	17.50	20.00	1,000

### Material

PBT, UL94V-0, natural

### RoHS compliance

## Shrouded header

### Side entry type

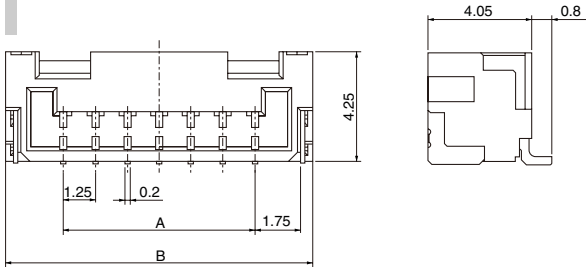

### Side feed type

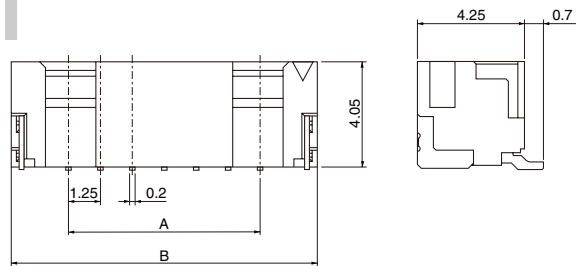

Circuits	Model No.		Dimensions (mm)		Q'ty / reel
	Side feed type	Side entry type	A	B	
2	BM02B-GVHS-TB	-	1.25	5.75	2,500
3	BM03B-GVHS-TB	SM03B-GVHS-TB	2.50	7.00	2,500
4	BM04B-GVHS-TB	-	3.75	8.25	2,500
5	BM05B-GVHS-TB	-	5.00	9.50	2,500
6	BM06B-GVHS-TB	-	6.25	10.75	2,500
7	BM07B-GVHS-TB	-	7.50	12.00	2,500
8	BM08B-GVHS-TB	-	8.75	13.25	2,500
9	BM09B-GVHS-TB	-	10.00	14.50	2,500
10	BM10B-GVHS-TB	-	11.25	15.75	2,500
11	BM11B-GVHS-TB	-	12.50	17.00	2,500
12	BM12B-GVHS-TB	-	13.75	18.25	2,500
13	BM13B-GVHS-TB	-	15.00	19.50	2,500
14	BM14B-GVHS-TB	-	16.25	20.75	2,500
15	BM15B-GVHS-TB	-	17.50	22.00	2,500

### Material and Finish

Contact: Phosphor bronze, copper-undercoated, tin-plated (reflow treatment)

Housing: PA 6T, UL94V-0, natural

Reinforcement: Brass, copper-undercoated, tin-plated (reflow treatment)

**RoHS compliance** This product displays (LF)(SN) on a label.

Note: Contact JST for gold-plated products.