



Product Features

- 50 – 1000 MHz
- ±0.2 dB Gain Flatness
- +25 dBm P1dB
- -74 dBc CTB / CSO
+39dBmV/channel, 77 channels
- +43 dBm Output IP3
- +77 dBm Output IP2
- Matched amplifiers for a push-pull configuration
- +5V Single Positive Supply
- MTTF > 1000 years

Applications

- CATV Head End Equipment
- CATV Line Amplifiers
- FTTH Repeaters

Product Description

The AH22S is a high dynamic range amplifier targeting cable TV markets. The combination of gain flatness, high linearity, and bandwidth makes it ideal for CATV distribution, cable modem, and laser diode driver applications.

The device uses two matched devices and is ideal for operation in a push-pull configuration to achieve high second order linearity. A mature and reliable GaAs MESFET technology is employed to maximize linearity at low power dissipation. The dual amplifier is housed in an industry standard surface-mount SOIC-8 package with all devices being 100% RF and dc tested. This device is available in a lead-free/green/RoHS-compliant package with NiPdAu plating material on the leads. It is compatible with both lead-free and lead soldering processes.

Functional Diagram

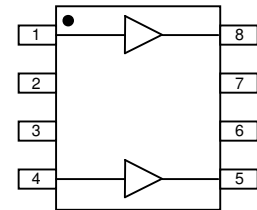

Function	Pin No.
Amp 1 Input	1
Amp 2 Input	4
Amp 2 Output	5
Amp 1 Output	8
Ground	2, 3, 6, 7, Backside paddle

Single-ended Device Specifications ⁽¹⁾

Parameter	Units	Min	Typ	Max
Operational Bandwidth	MHz	50		1000
Test Frequency	MHz		800	
Gain	dB	13	14.5	
Output IP3 ⁽²⁾	dBm	+37	+40	
Device Current	mA	120	160	190
Device Voltage	V		5	

1. Test conditions unless otherwise noted: 25 °C, Vd = +5 V, 800 MHz on each individual single-branch amplifier in a 50Ω test fixture.
2. 3OIP measured with two tones at an output power of +5 dBm/tone separated by 10 MHz. The suppression on the largest IM3 product is used to calculate the 3OIP using a 2:1 rule.
3. Typical parameters reflect performance in a push-pull application circuit as shown on page 3. Note that the feedback resistance values are R1 = R2 = 560Ω.
4. Balun, board, and connector losses have not been extracted, but typically account of 0.4 dB loss midband and 1.1 dB loss at 860 MHz.
5. Measured at +39 dBmV/channel, 77 channels Flat Loading.
6. OIP2 is measured at f1 + f2 at +8 dBm / tone.
7. OIP3 is measured at 8 dBm / tone with 10 MHz spacing.

Typical Performance ⁽³⁾

Parameter	Units	Typical			
Frequency	MHz	50	250	450	860
Gain ⁽⁴⁾	dB	11.3	11.1	11.1	11.1
Input Return Loss	dB	10.6	10.4	11.6	15.8
Output Return Loss	dB	17.1	15.4	15.4	18.2
CTB ⁽⁵⁾	dBc	-75	-74	-74	
CSO ⁽⁵⁾	dBc	-73	-86	-77	
XMOD ⁽⁵⁾	dBc	-63	-63	-63	
Output P1dB	dBm	+25.9	+26	+25.5	+24.7
Output IP2 ⁽⁶⁾	dBm	+79	+77	+77	+76
Output IP3 ⁽⁷⁾	dBm	+43	+45	+42	+42
Noise Figure	dB	6.1	4.6	4.5	4.2
Device Bias	V	+5 V @ 320 mA			

Absolute Maximum Rating

Parameter	Rating
Operating Case Temperature	-40 to +85 °C
Storage Temperature	-55 to +150 °C
Supply Voltage	+6 V
RF Input Power (continuous)	+13 dBm
Junction Temperature	+220 °C

Operation of this device above any of these parameters may cause permanent damage.

Ordering Information

Part No.	Description
AH22S-G	High Dynamic Range CATV Amplifier (lead-free/green/RoHS-compliant SOIC8 Pkg)
AH22S-PCB	Push-pull CATV Evaluation Board

Specifications and information are subject to change without notice.



Typical Device Data – 50Ω Z₀

S-Parameters (V_{ds} = +5 V, I_{ds} = 160 mA, T = 25 °C, unmatched 50 ohm system, calibrated to device leads)
This data represents a single-ended amplifier in the AH22S, with there being two matched amplifiers inside the package.

Freq (MHz)	S11 (dB)	S11 (ang)	S21 (dB)	S21 (ang)	S12 (dB)	S12 (ang)	S22 (dB)	S22 (ang)
50	-7.94	-19.61	15.23	168.38	-21.82	1.63	-15.80	-30.57
100	-8.21	-19.49	15.08	167.60	-21.70	-2.29	-16.57	-23.98
150	-8.22	-22.08	15.09	165.36	-21.79	-4.14	-16.83	-22.42
200	-8.25	-25.88	15.06	162.70	-21.72	-5.10	-17.08	-22.40
250	-8.21	-29.76	15.07	160.34	-21.71	-6.46	-17.15	-24.78
300	-8.23	-34.25	15.03	157.80	-21.68	-7.08	-17.08	-26.62
350	-8.23	-38.03	14.97	155.21	-21.61	-8.03	-17.41	-28.61
400	-8.26	-42.15	14.91	152.90	-21.62	-8.74	-17.56	-31.59
450	-8.21	-47.04	14.90	150.12	-21.57	-8.94	-17.49	-34.08
500	-8.17	-51.60	14.89	147.43	-21.58	-9.79	-17.75	-36.18
550	-8.11	-55.76	14.92	145.05	-21.53	-10.47	-17.80	-38.05
600	-8.14	-60.10	14.80	142.10	-21.47	-11.19	-18.07	-40.53
650	-8.13	-65.20	14.76	139.29	-21.49	-12.18	-18.25	-43.17
700	-8.02	-69.16	14.70	136.86	-21.41	-12.79	-18.42	-46.67
750	-8.04	-73.20	14.70	134.04	-21.38	-13.38	-18.69	-48.74
800	-8.02	-77.63	14.64	131.89	-21.30	-14.62	-18.86	-51.10
850	-7.98	-82.46	14.59	128.68	-21.26	-15.36	-18.96	-55.03
900	-7.91	-87.02	14.53	125.87	-21.16	-16.42	-19.19	-56.96
950	-7.86	-90.65	14.45	123.67	-21.12	-17.35	-19.48	-59.54
1000	-7.80	-94.58	14.39	121.33	-21.13	-18.12	-19.74	-63.18

Typical Device Data – 37.5Ω Z₀

S-Parameters (V_{ds} = +5 V, I_{ds} = 160 mA, T = 25 °C, unmatched 37.5 ohm system, calibrated to device leads)
This data represents a single-ended amplifier in the AH22S, with there being two matched amplifiers inside the package.

Freq (MHz)	S11 (dB)	S11 (ang)	S21 (dB)	S21 (ang)	S12 (dB)	S12 (ang)	S22 (dB)	S22 (ang)
50	-4.93	-12.81	14.35	170.16	-22.71	3.41	-9.19	-14.24
100	-5.09	-13.16	14.22	169.21	-22.57	-0.68	-9.40	-11.89
150	-5.12	-15.14	14.24	167.09	-22.64	-2.42	-9.51	-11.83
200	-5.17	-17.82	14.22	164.62	-22.55	-3.18	-9.61	-12.33
250	-5.18	-20.59	14.25	162.52	-22.53	-4.28	-9.66	-13.85
300	-5.23	-23.68	14.24	160.24	-22.47	-4.63	-9.66	-15.12
350	-5.28	-26.40	14.20	157.86	-22.38	-5.38	-9.83	-16.35
400	-5.36	-29.29	14.17	155.77	-22.36	-5.87	-9.95	-17.91
450	-5.39	-32.75	14.19	153.27	-22.28	-5.79	-9.96	-19.42
500	-5.45	-36.09	14.22	150.79	-22.26	-6.43	-10.12	-20.68
550	-5.48	-39.19	14.28	148.61	-22.17	-6.90	-10.17	-21.94
600	-5.58	-42.45	14.20	145.83	-22.07	-7.46	-10.35	-23.33
650	-5.69	-46.33	14.21	143.20	-22.04	-8.27	-10.51	-24.87
700	-5.70	-49.50	14.18	140.95	-21.93	-8.70	-10.66	-26.61
750	-5.81	-52.71	14.22	138.23	-21.86	-9.19	-10.83	-27.82
800	-5.92	-56.28	14.21	136.19	-21.73	-10.32	-10.97	-29.22
850	-6.02	-60.34	14.21	133.11	-21.64	-10.93	-11.15	-31.33
900	-6.10	-64.31	14.21	130.38	-21.49	-11.90	-11.32	-32.62
950	-6.17	-67.57	14.17	128.23	-21.41	-12.79	-11.55	-33.86
1000	-6.26	-71.12	14.16	125.92	-21.37	-13.52	-11.80	-35.45



75Ω Push-Pull Application Circuit

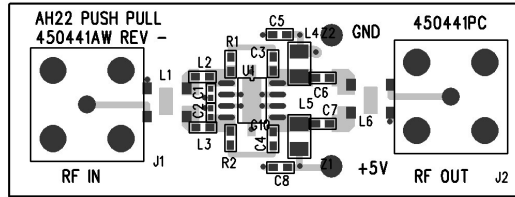

Circuit Board Material: .062" total thickness with a .028" FR4 top RF layer ($\epsilon_r=4.8$), 4 total layers (other layers added for rigidity), 1 oz copper

Typical RF Performance at 25°C

Frequency	MHz	50	250	450	860
Gain	dB	11.3	11.1	11.1	11.1
Input R.L.	dB	10.6	10.4	11.6	15.8
Output R.L.	dB	17.1	15.4	15.4	18.2
CTB	dBc	-75	-74	-74	
CSO	dBc	-73	-86	-77	
XMOD	dBc	-63	-63	-63	
Output P1dB	dBm	+25.9	+26	+25.5	+24.7
Output IP2	dBm	+79	+77	+77	+76
Output IP3	dBm	+43	+45	+42	+42
Noise Figure	dB	6.1	4.6	4.5	4.2
Device Current	mA	320			
Device Voltage	V	+5			

- Balun, board, and connector losses have not been extracted, but typically account of 0.4 dB loss midband and 1.1 dB loss at 860 MHz.
- CSO, CTB, & XMOD are measured at +39 dBmV/channel, 77 channels Flat Loading.
- OIP2 is measured at f1 + f2 at 8 dBm / tone.
- OIP3 is measured at 8 dBm / tone with 10 MHz spacing.

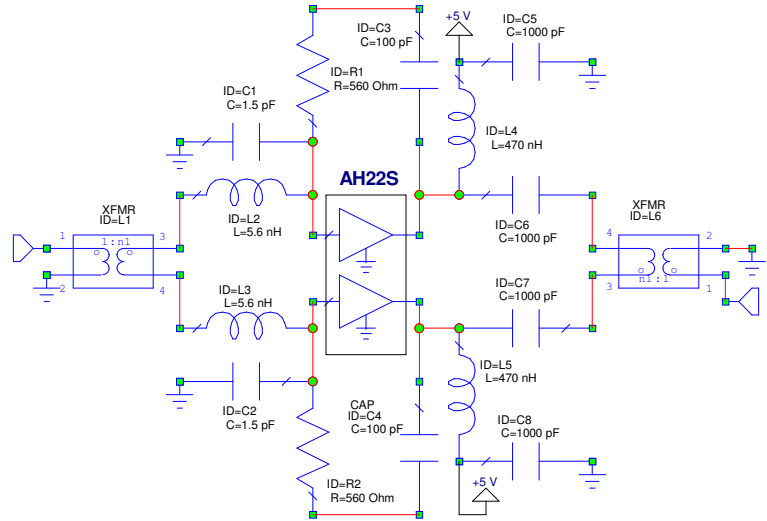

The transformers, L1 and L6, used on the WJ evaluation board are handwound baluns using these materials: 6 turns bifilar wire (MWS B2383211) around a ferrite core (TDK, H5C2-T3.1-1.3-1.3). An SMT transformer (M/A Com ETC1-1-13) can also be used.

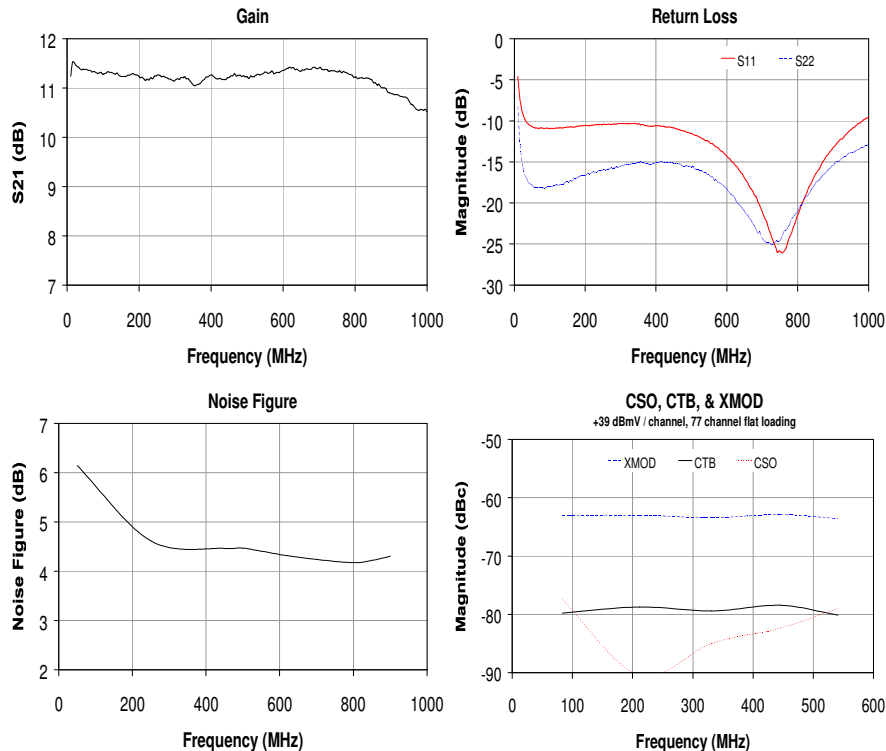

Specifications and information are subject to change without notice.

AH22S-G (Lead-Free Package) Mechanical Information

This package is lead-free/green/RoHS-compliant. The plating material on the leads is NiPdAu. It is compatible with both lead-free (maximum 260 °C reflow temperature) and lead (maximum 245 °C reflow temperature) soldering processes.

Outline Drawing

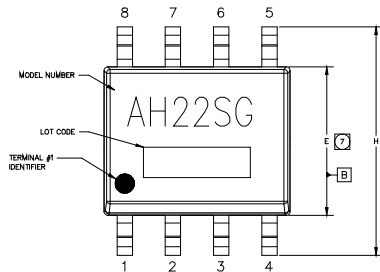

- NOTES
- EXCEPT WHERE NOTED, THIS PART OUTLINE CONFORMS TO JEDEC STANDARD MS-012, ISSUE C FOR SMALL OUTLINE (SO) PERIPHERAL TERMINALS 3.75mm BODY WIDTH (PLASTIC).
 - DIMENSIONING & TOLERANCING CONFORM TO ANSI Y14.4M-1994.
 - ALL DIMENSIONS ARE IN MILLIMETERS (INCHES). ANGLES ARE IN DEGREES.
 - DOES NOT INCLUDE WELD FLASH, PROTRUSIONS OR GATE BURRS, WHICH SHALL NOT EXCEED .15mm(.006in) PER SIDE.
 - DEVIATION FROM JEDEC MS-012 STANDARD.
 - LENGTH OF TERMINAL FOR SOLDERING TO A SUBSTRATE.
 - DOES NOT INCLUDE INTER-LEAD FLASH OR PROTRUSIONS, WHICH SHALL NOT EXCEED .25mm(.010in) PER SIDE.

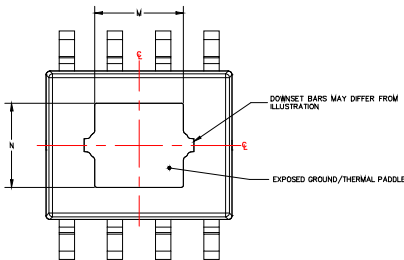
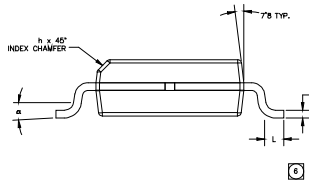
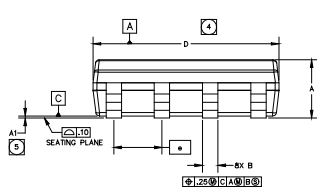

SYMBOL	MILLIMETERS			INCHES		
	MIN	NOM	MAX	MIN	NOM	MAX
A	1.42	1.52	1.62	.056	.060	.064
A1	0	.06	.10	0	.002	.004
B	.38	.41	.43	.015	.016	.017
C	.19	.20	.26	.007	.008	.010
D	4.80	4.80	5.00	.189	.193	.197
E	3.80	3.90	4.00	.150	.154	.157
e	1.27 BSC			.050 BSC		
H	5.80	6.0	6.20	.228	.236	.244
h	.25	.35	.50	.010	.013	.020
L	.40	.84	1.27	.016	.033	.050
M	2.21	2.34	2.47	.087	.092	.097
N	2.08	2.21	2.34	.082	.087	.092
a	0	4°	8°	0	4°	8°

Land Pattern

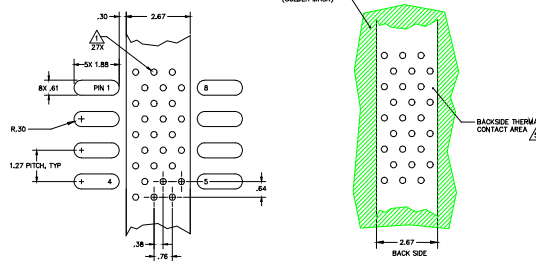
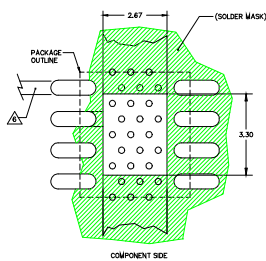

Thermal Specifications

Parameter	Rating
Operating Case Temperature	-40 to +85 °C
Thermal Resistance ⁽¹⁾ , Rth	28 °C/W
Junction Temperature ⁽²⁾ , Tj	130 °C

Notes:

- The thermal resistance is referenced from the hottest part of the junction to ground tab underneath the device.
- This corresponds to the typical biasing condition of +5V, 320 mA at an 85 °C case temperature. A minimum MTTF of 1 million hours is achieved for junction temperatures below 160 °C.

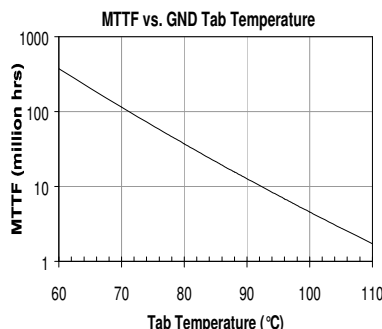

Product Marking

The component will be marked with an "AH22SG" designator with an alphanumeric lot code on the top surface of the package. The obsolete tin-lead package is marked with an "AH22S" designator followed by an alphanumeric lot code.

Tape and reel specifications for this part are located on the website in the "Application Notes" section.

ESD / MSL Information

ESD Rating: Class 1B
 Value: Passes from 500 to 1000 V
 Test: Human Body Model (HBM)
 Standard: JEDEC Standard JESD22-A114

ESD Rating: Class IV
 Value: Passes greater than 1000 V
 Test: Charge Device Model (CDM)
 Standard: JEDEC Standard JESD22-C101

MSL Rating: Level 2 at +260 °C convection reflow
 Standard: JEDEC Standard J-STD-020A

Functional Pin Layout

Pin	Function
1	RF input (Amp1 input)
2	Ground
3	Ground
4	RF input (Amp2 input)
5	RF output (Amp2 output)
6	Ground
7	Ground
8	RF output (Amp1 output)

The backside paddle is the Source and should be grounded for thermal and electrical purposes.

Mounting Config. Notes

- Ground / thermal vias are critical for the proper performance of this device. Vias should use a .35mm (#80/.0135") diameter drill and have a final plated through diameter of .25mm (.010")
- Add as much copper as possible to inner and outer layers near the part to ensure optimal thermal performance.
- To ensure reliable operation, device ground paddle-to-ground pad solder joint is critical.
- Add mounting screws near the part to fasten the board to a heatsink. Ensure that the ground / thermal via region contacts the heatsink.
- For optimal thermal performance, expose soldermask on backside where it contacts the heatsink.
- RF trace width depends upon the PC board material and construction.
- Use 1 oz. Copper minimum.
- If the PCB design rules allow, ground vias should be placed under the land pattern for better RF and thermal performance. Otherwise ground vias should be placed as close to the land pattern as possible.
- All dimensions are in mm. Angles are in degrees.

Specifications and information are subject to change without notice.