



U7SH08

CMOS IC

2-INPUT AND GATE

DESCRIPTION

The U7SH08 is a 2-input AND gate which provides the Function $Y=A*B$.

This device has power-down protective circuit, preventing device destruction when it is powered down.

FEATURES

- * Operation Voltage Range: 2~5.5V
- * Low Power Dissipation: $I_{CC}=2\mu A(\text{Max})$
- * High Speed: $t_{PD}=4.3ns(\text{Typ})$
- * High Noise Immunity: $V_{NIH} = V_{NIL}=0.28*V_{CC}(\text{Min})$

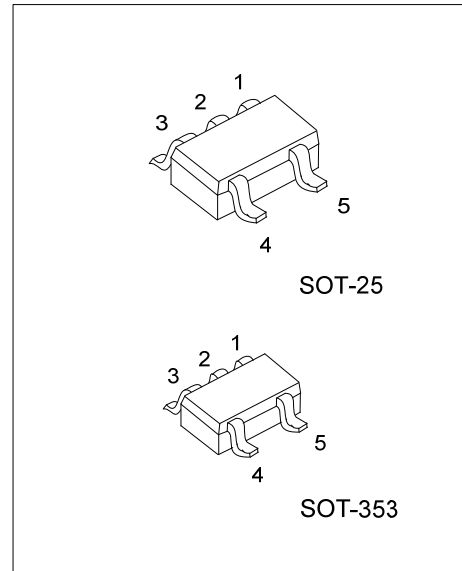

ORDERING INFORMATION

Ordering Number	Package	Packing
U7SH08G-AF5-R	SOT-25	Tape Reel
U7SH08G-AL5-R	SOT-353	Tape Reel

<p>U7SH08G-AF5-R</p> <p>(1)Packing Type (2)Package Type (3)Halogen Free</p>	<p>(1) R: Tape Reel (2) AF5: SOT-25, AL5: SOT-353 (3) G: Halogen Free</p>
-------------------------------------------------------------------------------------	-----------------------------------------------------------------------------------

MARKING

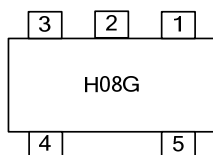

SOT-25

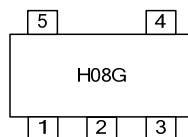

SOT-353

■ PIN CONFIGURATION

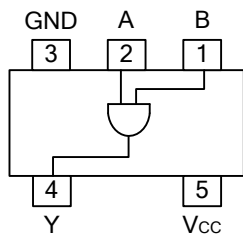

■ FUNCTION TABLE (Each Gate)

INPUT		OUTPUT
A	B	Y
L	L	L
L	H	L
H	L	L
H	H	H

■ LOGIC DIAGRAM (Positive Logic)

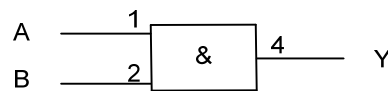
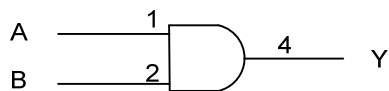

IEC logic symbol

■ ABSOLUTE MAXIMUM RATINGS

PARAMETER	SYMBOL	RATINGS	UNIT
Supply Voltage	V_{CC}	-0.5~7	V
Input Voltage	V_{IN}	-0.5~7	V
Output Voltage	V_{OUT}	-0.5~ $V_{CC}+0.5$	V
Input Clamp Current	I_{IK}	-20	mA
Output Clamp Current	I_{OK}	±20	mA
Output Current	I_{OUT}	±25	mA
V_{CC} or GND Current	I_{CC}	±50	mA
Power Dissipation	P_D	200	mW
Storage Temperature	T_{STG}	-65 ~ +150	°C

Note 1. The input and output voltage ratings may be exceeded if the input and output current ratings are observed.

2. Absolute maximum ratings are those values beyond which the device could be permanently damaged.

Absolute maximum ratings are stress ratings only and functional device operation is not implied.

■ RECOMMENDED OPERATING CONDITIONS

PARAMETER	SYMBOL	CONDITIONS	MIN	TYP	MAX	UNIT
Supply Voltage	V_{CC}		2		5.5	V
Input Voltage	V_{IN}		0		5.5	V
Output Voltage	V_{OUT}		0		V_{CC}	V
Input Transition Rise or Fall Rate	$\Delta t/\Delta v$	$V_{CC}=3.3+0.3V$			100	ns/V
		$V_{CC}=5.0+0.5V$			20	
Operating Temperature	T_A		-40		85	°C

■ STATIC CHARACTERISTICS ($T_A=25^\circ\text{C}$)

PARAMETER	SYMBOL	TEST CONDITIONS	MIN	TYP	MAX	UNIT
High-Level Input Voltage	V_{IH}	$V_{CC}=2.0V$	1.5			V
		$V_{CC}=3.0V$	2.1			
		$V_{CC}=5.5V$	3.85			
Low-Level Input Voltage	V_{IL}	$V_{CC}=2.0V$			0.5	V
		$V_{CC}=3.0V$			0.9	
		$V_{CC}=5.5V$			1.65	
High-Level Output Voltage	V_{OH}	$V_{CC}=2.0V, I_{OH}=-50\mu A$	1.9	2.0		V
		$V_{CC}=3.0V, I_{OH}=-50\mu A$	2.9	3.0		
		$V_{CC}=4.5V, I_{OH}=-50\mu A$	4.4	4.5		
		$V_{CC}=3.0V, I_{OH}=-4mA$	2.58			
		$V_{CC}=4.5V, I_{OH}=-8mA$	3.94			
Low-Level Output Voltage	V_{OL}	$V_{CC}=2.0V, I_{OL}=50\mu A$			0.1	V
		$V_{CC}=3.0V, I_{OL}=50\mu A$			0.1	
		$V_{CC}=4.5V, I_{OL}=50\mu A$			0.1	
		$V_{CC}=3.0V, I_{OL}=4mA$			0.36	
		$V_{CC}=4.5V, I_{OL}=8mA$			0.36	
Input Leakage Current	$I_{I(LEAK)}$	$V_{CC}=0\sim 5.5V, V_{IN}=V_{CC}$ or GND			±0.1	μA
Quiescent Supply Current	I_Q	$V_{CC}=5.5V, V_{IN}=V_{CC}$ or GND, $I_{OUT}=0$			2	μA
Input Capacitance	C_{IN}	$V_{CC}=5.0V, V_{IN}=V_{CC}$ or GND		4	10	pF

■ DYNAMIC CHARACTERISTICS (T_A=25°C, Input: t_R,t_F≤3ns; PRR≤1MHz)

PARAMETER	SYMBOL	TEST CONDITIONS	MIN	TYP	MAX	UNIT
Propagation delay from input (A and B) to output(Y)	t _{PLH}	V _{CC} =3.3±0.3V, C _L =15 pF		6.2	8.8	ns
	t _{PHL}			6.2	8.8	
	t _{PLH}	V _{CC} =3.3±0.3V, C _L =50 pF		8.7	12.3	
	t _{PHL}			8.7	12.3	
Propagation delay from input (A and B) to output(Y)	t _{PLH}	V _{CC} =5±0.5V, C _L =15 pF		4.3	5.9	ns
	t _{PHL}			4.3	5.9	
	t _{PLH}	V _{CC} =5±0.5V, C _L =50 pF		5.8	7.9	
	t _{PHL}			5.8	7.9	
OPERATING CHARACTERISTICS						
Power Dissipation Capacitance	C _{pd}	No load, f=1MHz, V _{CC} =5		14		pF

■ TEST CIRCUIT AND WAVEFORMS

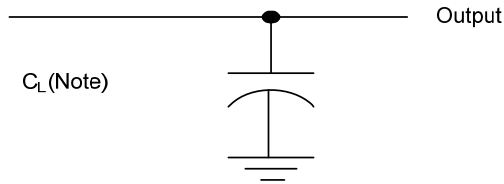

Note: CL includes probe and jig capacitance.

Fig-1 Load circuitry for switching times

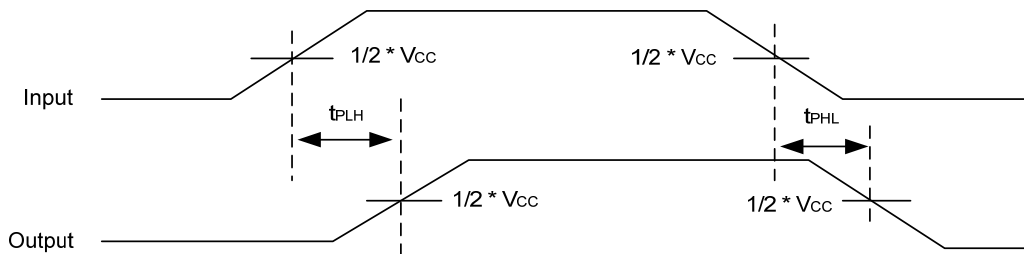

Fig-2 Propagation delay from input (A and B) to output(Y).

UTC assumes no responsibility for equipment failures that result from using products at values that exceed, even momentarily, rated values (such as maximum ratings, operating condition ranges, or other parameters) listed in products specifications of any and all UTC products described or contained herein. UTC products are not designed for use in life support appliances, devices or systems where malfunction of these products can be reasonably expected to result in personal injury. Reproduction in whole or in part is prohibited without the prior written consent of the copyright owner. The information presented in this document does not form part of any quotation or contract, is believed to be accurate and reliable and may be changed without notice.